

FARU 2018 - PROCEEDINGS

“Sustainability for people” *envisaging multi disciplinary solution*

The peer reviewed and accepted research papers of the conference are included in this volume

About FARU

FARU is the research unit of the Faculty of Architecture, University of Moratuwa, Sri Lanka. FARU which consists of four academic departments: Architecture, Town and Country Planning, Building Economics and Integrated Design) organizes international research conferences for the past ten years. It attracts academics, students and practicing professionals.

FARU 2018 is held in Galle (at the Light House Hotel, Galle) for the 11th year consecutive year and, is co-sponsored by University of Moratuwa, Royal Ceramics Lanka Plc, International Construction Consortium (Pvt) Ltd. The FARU Organizing Committee acknowledges the support extend by the University of Moratuwa and all sponsors.

© 2018 by Faculty of Architecture Research Unit

Published by Faculty of Architecture
University of Moratuwa, Moratuwa, Sri Lanka
December 2018

ISBN 978-955-9027-74-4

Editor

Dr. (Mrs.) Sumanthri Samarawickrama

Formatting

AMS Attanayake
Priyanwada Thalys

Conference Logo design

Sasheen Attanayake

Tele/Fax: +94 11 2650216, Email: faru@uom.lk

Web: <https://www.mrt.ac.lk/web/foa/faru>



List of Paper Reviewers for FARU 2018

1. **Professor Juergen Reichardt**
Munster University of Applied Sciences, Germany
2. **Prof. Samitha Manawadu**
Senior Professor, Department of Architecture, University of Moratuwa, Sri Lanka
3. **Professor Rohinton Emmanuel**
Professorin Sustainable Design, Glasgow Caledonian University, UK
4. **Dr. (Mrs.) Sepani Senaratne**
Senior Lecturer, Western Sydney University, Australia
5. **Dr. (Mrs.) Indrika Rajapaksha**
Senior Lecturer, Department of Architecture, University of Moratuwa, Sri Lanka
6. **Dr. D.P. Chandrasekera**
Senior Lecturer, Department of Architecture, University of Moratuwa, Sri Lanka
7. **Dr. (Mrs.) Shaleeni Cooray**
Senior Lecturer, Department of Architecture, University of Moratuwa, Sri Lanka
8. **Dr. Rangajeewa Rathnayaka**
Senior Lecturer, Department of Town and Country Planning, University of Moratuwa, Sri Lanka
9. **Dr. (Mrs.) Wajishani Gamage**
Senior Lecturer, Department of Architecture, University of Moratuwa, Sri Lanka
10. **Dr. Narein Perera**
Senior Lecturer, Department of Architecture, University of Moratuwa, Sri Lanka
11. **Dr. Gamini Weerasinghe**
Senior Lecturer, Department of Architecture, University of Moratuwa, Sri Lanka
12. **Dr. Rizvi Noordeen**
Senior Lecturer, Department of Town and Country Planning, University of Moratuwa, Sri Lanka
13. **Dr. Amila Jayasinghe**
Senior Lecturer, Department of Town and Country Planning, University of Moratuwa, Sri Lanka
14. **Dr. (Mrs.) Gayathri Ranathunga**
Senior Lecturer, Department of Textile & Clothing Technology, University of Moratuwa, Sri Lanka
15. **Dr. (Mrs.) Virajini Karunarathne**
Senior Lecturer, Department of Textile & Clothing Technology, University of Moratuwa, Sri Lanka
16. **Dr. (Mrs.) Sumantri Samarawickrama**
Senior Lecturer, Department of Integrated design, University of Moratuwa, Sri Lanka

Organizing Committee: FARU 2018

Dean, Faculty of Architecture

Prof. Lalith de Silva

Director Faculty of Architecture Research Unit FARU

Dr. (Mrs.) Sumanthri Samarawickrama

Members

Dr. D.P. Chandrasekera, Dr. Upendra Rajapaksha, Dr. (Ms.) Thilini Jayawickrama, Dr.(Ms.) Wathsala Gunawardena, Dr. (Ms.) Wajishani Gamage, Archt. Sagara Jayasignhe

Secretariat

Mr. A M S Attanayake, Mr. R A J Kithsiri, Ms. Priyanwada Thalís

Contents

Editor's note	08
Social Networks for Knowledge Management in Multinational Real Estate Consultancy Firms - A Literature Review <i>Senaratne. S, Abeysinghe. N.S.D & Andaraweera. A.K</i>	09
Gender Mainstreaming in Urban Planning: <i>An exploratory study of women's perception on liveability in Keonjhar city, Odisha.</i> <i>Swagatika Mishra, Neeraj Gupta & Bhumika Sharma</i>	17
Landslides Prediction Based on Neural Network and Remote Sensing Data <i>L. D. C. H. N. Kalpana & L. D.C. S. Subhashini</i>	25
Effects of Open Plan Workspaces on Job Satisfaction: A Study on Software Development Professionals in Colombo <i>Naranpanawa. Y.I. & Hettiarachchi. A.A.</i>	34
Using Visibility for Enhancing Spatial Interaction within an Organically Developed Neighborhood of <i>Dholaikhal</i> , Old Dhaka. <i>Catherine Daisy Gomes, Simita Roy & Brishti Majumdar</i>	42
Impact of Spatial Perception on Placemaking in Open Spaces of Middle Class Housing Schemes around Colombo <i>Manawadu T. & Dharmasena J.</i>	50
Possibility of Recycling Plastics from Municipal Solid Waste (MSW) and their Potential Applications in Construction Industry <i>Jayathilaka W.M.D.S., Chandrasena N., Premachandra J. & Halwatura R.U.</i>	59
Improve Intrinsic Properties of Walling Materials to Create Occupant Comfort <i>Galkanda. H, Udawattha. C & Halwatura. R</i>	66
Understanding Characteristics of Pedestrians and Design Path <i>Phunshok Chhime Dolkar & Ratnayake. Rangajeewa</i>	74
A Study of Urban Neighbourhood Open Spaces and their Propensity to Encourage Crime With Reference to Kotahena. <i>Aishan Ranasinghe & Gamini Weerasinghe</i>	80
Effectiveness of a Discretely Supported Slab Insulation System in terms of Thermal Performance <i>Kasun Nandapala, Madujith Sagara Chandra & R.U. Halwatura</i>	91
Impact of Schedule Compression on Successful Delivery of Sri Lankan Construction Projects <i>Wickramasinghe B.M.S.M & Disaratna V.</i>	99
A Framework to Implement Design and Built Practices for Green and Adaptive Reuse of Existing Buildings <i>Wijesiri W.M.M., Devapriya K.A.K. & Rathnasiri H.W.T.P.</i>	107
The Role of Facilities Management in Logistics and Warehousing in Sri Lanka <i>Ratnayake. A, Abeysinghe N.S.D. & Andaraweera. A.K.</i>	116
Impact of Surface Cover and Surrounding area on Microclimate of Urban Wetland Park, Nugegoda <i>Madhuranga T. R. I. & Rajapaksha R. M. K. U.</i>	123

Simulation Based Design for Sustainable and Contextual Architecture <i>Shammi Akter Keya & Noshin Siara Promy</i>	132
Body-Centric Transformable Adornments: A Sustainable Approach <i>Jayawardhana Komangodage Methma Jayawardhana & K.K.G.I.C. Samarasekara</i>	139
Influence of Organisational Culture on Knowledge Management in a BIM Enabled Environment <i>Tennakoon T.M.M.P., Wijewickrama M.K.C.S., Kulatunga U. & Jayasena H.S.</i>	144
Present Trends in Income and its Impact on Affordability of Multi-Ownership Housing <i>Nayna Tabassum & Simita Roy</i>	155
Influence of Tree Shade Level on Comfort Perception - A Case Study of Outdoor Public Spaces of Viharamahadevi Park, Colombo <i>Caldera. A & Perera. N. G. R</i>	165
Cost Effectiveness of Sustainable Electricity Consumption in Domestic Buildings. <i>Thilina Laksiri Dissanayake & Anuji Arunoda Wahalathanthri</i>	174
Design Approaches to Revitalize a Canal Front: A Case Study Along Chaktai Commercial area of Chittagong, Bangladesh <i>Sarah Binte Haque & Mahdi Mahmudul Hoque</i>	182
A Study on Visitor Perception and their Cognition of Cultural Landsapes: With Special Reference to the Temple of the Tooth, Kandy <i>Ranasinghe E. & Samitha M.</i>	190
Releasing the Barricades: Reintegrating Central Jail Through ‘Placemaking’ in Old Dhaka <i>Noshin Siara Promy & Shammi Akter Keya</i>	204
Sustainable Water Management in Irrigation Systems <i>Sirimewan D.C. & Manjula N.H.C.</i>	212
Expected Impact on Design Delivery Risk in BIM Based Project Implementation in Sri Lanka <i>Dissanayake. A.G.N.D., Jayasena. H.S., & Wijewickrama. M.K.C.S</i>	220
The Impact of Artificial Lighting on Visual Comfort and Visual Satisfaction of People with Special Reference to Outdoor Public Spaces in Colombo <i>Bandara. A, Ranasinghe. S & Hettiarachchi. A</i>	228
Impact of Organization Patterns in Landscape Elements on Visitor Legibility <i>A study with reference to Sigiriya</i> <i>Dissanayake. D. S. P. R. & Dharmasena J. P.</i>	244
Mapping “Wind Comfort” in Public Urban Spaces of Galle Fort, Sri Lanka <i>Wimalarathne. K.L.L, Perera. N.G.R & Emmanuel. R</i>	254
Envisioning Graveyards in Dense Urban Areas in Context of Dhaka City from Preserved Hallowed Ground towards Healing Landscape for the Community <i>Sikder S.P. & Alam F.</i>	262
Labour Productivity in Plastering Works in Sri Lankan Construction Industry <i>Pasath. V, Dissaratne. V, Ganshu P. & N.F.Sabrina</i>	271
The Impact of Landscape Characteristics of Urban Pockets on Visitors and Residents <i>A study with reference to Kandy City</i> <i>Madawala. W. R. H. B. Y. M. R. S. R. & Chandrasekara. D. P.</i>	280

Urban Alleyways as a Functional Landscape Element and its Effect on Liveable City A study with reference to Kandy City <i>Gunarathne. C. P. A. & Chandrasekara. D. P.</i>	292
Appraising the Influence of Landscape Design on Traffic Generated Air Pollution of Urban Parks <i>I. Rajapaksha & M. Ekanayake</i>	308
Late Colonial Period Merchant Houses at Birulia: A Study on Architectural Features <i>Adnan Enam Rabbi, & Islam, Tazrin</i>	316
Implementing Building Energy Efficiency Retrofits (Beer) in Hotel Buildings: A Case Study of Shallow Retrofit <i>M.F.F. Fasna & Sachie Gunatilake</i>	325
Urban Water Body Development for Recreational Purposes in Sri Lanka: A Comparative Study of Public Perception and Willingness to Pay <i>Ratnayake. R, Wickramaarachchi. N & Wattege. P</i>	333
Form Development of Clay Module for Optimize Evaporative Cooling with Wind Flow <i>Liyanarathne. B.L.S.W., Ranasinghe. W.M.N.D. & Halwatura R.U.</i>	341
Experimental Investigation on the Optimal Lifting Height of a Self-Compacting in-Situ Cast Mud-Concrete Load-Bearing Wall Segment <i>F.R. Arooz, K.L.T.H. Perera, Madujith Sagara Chandra & R.U. Halwatura</i>	346
The Effectiveness of Street Characteristics for Creating a City Image; A study of Galle road, Colombo <i>Perera D.D.S. & Coorey S.</i>	354
Identification of Functionality and Usability Aspects of Traditional Paathraya' in Sri Lanka <i>Thilakarathna. K.C.M. & Ranasinghe. W.M.N.D.</i>	367
Impact of Outdoor Learning Landscape on Psychomotor Skill of Primary School Children Cases from Colombo, Sri Lanka <i>Perera B.T.S & Hettiarachchi.A.A.</i>	377
From Horizontal to Vertical: Habitus Transformation in Resettlement of Underserved Communities to High Rise Buildings <i>Randima De Silva & Prasad Botejue</i>	387
Green BIM For Existing Buildings <i>Pavithra Rathnasiri & Suranga Jayasena</i>	394
Implementation of RIBA Plan of Work (2013) at Pre-contract Phase to Minimize Conflicts of Construction Projects in Sri Lanka <i>Kanchuka Withanage & Nayanathara De Silva</i>	402
Sustainable Applications behind Geographically Indigenous Product Cultures A study of village communities in central high valley, Sri Lanka. <i>Dulaj Perera. W & Dilshani Ranasinghe. W. M. N.</i>	411
A Comparative Analysis about the Indoor Thermal Environment of a Room with and without Transitional Space or Threshold in Traditional Row Houses Adjacent to a Narrow Alley "Rupchan Lane" in Old Dhaka, Bangladesh <i>Fatema Tasmia, Brishti Majumder & Atiqur Rahman</i>	421
Sinhala Traditional Music of Sri Lanka for Stress Relief: An Interaction Design Intervention <i>Samangi Wadinambi Arachchi & Sumanthri Samarawickrama</i>	431

Non-Verbal Communicative Aspects of Verandah in “ <i>Walauwa</i> ” Under Uva Province: A Case Study <i>Mendis.M.S., Jayasignhe.S</i>	440
Competencies of Quantity Surveyors in a Developing Economy <i>Vidana Gamage Shanika, Yashoda Dissanayake & Vijitha Disaratne</i>	448
Perception of Contractors on Usage of Alternative Dispute Resolution Methods in Construction Industry of Sri Lanka <i>Dissanayake D.M.A.B, Abeynayake M.D.T.E & Pandithawatta T.P.W.S.I.</i>	457
Product Usability of Utensils used in Nasya Karma of Sri Lankan Indigenous Medicine; with Special Reference to the <i>Gokarna Yantra</i> <i>Udari Mohotti & Dilshani Ranasinghe</i>	465
Impact of Water Bodies as Natural Landscape Elements on Urban Microclimate in the Context of Dhaka in terms of Thermal Comfort <i>Md Raisul Mostafa & Sarjana Afroz</i>	482

Editor's note

Faculty of Architecture Research Unit (FARU) of University of Moratuwa, Sri Lanka has organized the 11th FARU International Research Conference under the main theme of 'Sustainability for People' and focused on envisaging multi disciplinary solutions. The conference provides as a forum for researchers, academics, practitioners and students in the areas of architecture, built environment, planning, building economics and integrated design.

Theme of FARU 2018 discusses how sustainability expands to a wide spectrum, by envisaging to the basic and modern needs of people. Furthermore, it addresses multi disciplinary approaches across built environment, construction industry, urban planning and design for people. FARU 2018 opened up the platform to discuss this through multi-disciplinary solutions and invited research papers on the following sub themes:

- Built environment for people
- Construction industry for people
- Urban planning for people
- Design for people

I wish to congratulate all the authors for their contribution, sharing their insights that will provide ample opportunity for discussion, debate and exchange of ideas, information among the conference participant.

Looking forward for a successful conference.

Dr. Sumanthri Samarawickrama

Director, Faculty of Architecture Research Unit
Faculty of Architecture, University of Moratuwa, Sri Lanka

Samarawickrama, Sumanthri, et al (eds), 2018, "Sustainability for people - envisaging multi disciplinary solution": *Proceedings of the 11th International Conference of Faculty of Architecture Research Unit (FARU), University of Moratuwa, Sri Lanka, December 08, 2018* Galle pp. 09–16. ©

SOCIAL NETWORKS FOR KNOWLEDGE MANAGEMENT IN MULTINATIONAL REAL ESTATE CONSULTANCY FIRMS - A LITERATURE REVIEW

SENARATNE. S¹, ABEYSINGHE. N.S.D² & ANDARAWEEERA. A.K³

¹Western Sydney University, Sydney, Australia, ^{2,3}Edward Constantine Private Limited, Colombo, Sri Lanka

¹s.senaratne@westernsydney.edu.au, ²nelushi.abeyasinghe@gmail.com, ³andaraweera@outlook.com

Abstract

Knowledge can be defined as a dynamic social construction of reality dependent upon the specific experiences made by individuals; it does not already exist in individuals but is continuously produced and revised in a social process. This paper seeks to review the role of social networks in knowledge management in the business context of Multi-National Real Estate Consultancy Firms (MNRECF) considering knowledge as a social construction. Services provided by MNRECFs depend largely on the application of knowledge and expertise. They are depended on three knowledge areas – based fundamental resources, which are their people; the client relationships; and the intellectual capital. It is the knowledge that extends beyond knowing how to do a particular job, how to deploy people to make the best use of their talents, how to make decisions that help build a strong client base, and how to guide change as markets and conditions change. In the modern economic environment, social network concepts have become increasingly interesting to many companies, since the evolution of network relationships within and between firms affect most companies. Social networks are used to examine associations and connections between individual employees, as well as how companies interact with each other; it is a key ingredient of Knowledge Management (KM) in MNRECFs. However, current knowledge is lacking in this area due to limited research undertaken. Therefore, this paper aims to explore social networks in MNRECFs based on a literature review and provide an account of relevant KM tools supporting social networks. Future research will select case studies to explore the concepts further.

Keywords: *Knowledge; Knowledge management; Multi-National Real Estate Consultancy Firms; Social networks; Real Cases.*

1. Introduction

Multinational Real Estate Consultancy Firms (MNRECF) are businesses that operate based on the specialized knowledge, extensive experience and expertise of their teams of experts who process knowledge of the interplay amongst asset valuation, capital markets, and real estate marketplaces as well as issues that affect client's day-to-day business operations (Deloitte2013).

Transferring knowledge through one-to-one conversations has been threatened by the increasing movement of the consultants of MNRECFs across different countries. In some MNRECFs, expert teams are placed in a single centralized location, in one multi-national conglomerate, within their Sri Lankan operations, the expert team for the Asia Pacific region is centralized to a single country, which is Singapore. Therefore, there is a persistent need in these knowledge-intensive organizations for knowledge to be well managed to counter the limitations arising from the common uneven distribution of knowledge (Fong & Choi2013). This is echoed by Nissen (2004, p7), who highlights that "efficient knowledge flow is critical to enterprise performance." Despite its integrally critical role, knowledge is often not managed in an orderly manner, and its contribution to a firm's success is usually disregarded. These firms may cling to the opinion that investment in knowledge processes is doubtful to increase their business, and inadequate to produce proportional financial returns (Fong & Choi2013). However, a thorough research, which can show them how knowledge management can largely add value to their Organizations, while increasing the performance, benefiting their Clients, lowering their costs and increasing profits is worthwhile taking in an era where there is a large tendency for MNRECFs to expand their business across many more countries. Since the evolution of network relationships has impacted most companies in the modern economy setting, Social Network concept has become the

focus of many companies (Seufert, Grogh&Bach1999). Organizations' tacit knowledge sharing is mainly and structurally supported by the Social Networking (Papailiou, Apostolou&Mentzas2005). In MNRECFs, members belong to one category or department dispersed in wide spread locations, in the above referred example of a multi-national conglomerate, supply chain strategic level members are in Singapore whereas operational level members are placed in countries such as Sri Lanka, India etc. Therefore, there is a strong requirement for flexible and easy to deploy collaborative KM tools.

Thorough research reveals the value of using knowledge sharing networks in MNRECFs. However, there is sparse research regarding this context. This research project aims to evaluate the role of social networks in KM within MNRECFs considering knowledge as a social construct.

2. Research question

This research seeks to review the role of social networks in knowledge management in the business context of MNRECFs. Since nature of knowledge is not well defined in MNRECFs context, the role of social networks in knowledge management is not well understood. This created the knowledge gap for this research and emerged the research question for the study. Accordingly, the research question that was developed for the study is, 'What is the role of Social Networks in Knowledge Management in the business context of MNRECFs?'

3. Knowledge & Knowledge Management

Razmerita, Kirchner & Sudzina 2009 define knowledge as a fluid mix of framed experience, values, contextual information, and expert insight that provides a framework for evaluating and incorporating new experiences and information. It originates and is applied in the minds of knower. Knowledge is progressively more regarded as a survival tool in a dynamic and competitive environment (Laudon and Laudon, 2000). Drucker (1993) shared this view and stated in his text, "Post-capitalist society", that "the basic economic resource is no longer capital, natural resources, nor labor. It is and will be 'knowledge'. Therefore, there is a pressing need in every knowledge-intensive organization for knowledge to be well managed in order to cope with the shortcomings arising from the common uneven distribution of knowledge in these organizations. This is echoed by Nissen (2004) who emphasizes that "efficient knowledge flow is critical to enterprise performance". In spite of its inherently crucial role, knowledge is often not managed in a systematic manner in MNRECFs, and its contribution to firm success is commonly overlooked. These firms may hold the belief that investment in knowledge processes is unlikely to boost their business enough to generate proportionate financial returns (Drucker, 1993).

As stated by Levin & Cross, 2004 "knowledge Management is refers to identifying and leveraging the individual and collective knowledge in an organization to support the organization in becoming more competitive; problems with maintaining, locating, and applying knowledge have led to systematic attempts to manage knowledge". Knowledge management systems help create, store, retrieve, transfer, and apply knowledge. They can also enable collaboration and communication among knowledge workers within and across various domains (Fischer and J. Ostwald, 2001). Traditionally, such systems have helped document explicit knowledge— that is, knowledge that's easily codified and articulated, such as what is in a user manual.

4. Knowledge Management & Social Networking

However, organizations are starting to include social networking features in their knowledge management infrastructure to capture tacit, social, and individual knowledge as well. Tacit knowledge is difficult to codify because it's "rooted in action, experience, and involvement in a specific context (Alavi and Leidner, 2001). Social knowledge is created by group actions and includes social norms for these interactions, and individual knowledge comes from an individual gaining insight after completing a project/work (Alavi and Leidner, 2001). Research shows that employees who frequently interact transfer knowledge more effectively (Levin and Cross, 2004) supporting the notion that community networking is an important part of knowledge management—especially for tacit knowledge. Integrating social networking into knowledge management systems can increase interactions between employees, which can in turn increase their level of trust and encourage more effective collaboration and communication (Swan, 1999). Many organizations are thus incorporating tools such as Microsoft

SharePoint into their knowledge management infrastructure to set up websites accessible through intranets or the Internet and to help employees create, store, and retrieve documents in various formats (Levin and Cross, 2004).

4.1. KNOWLEDGE GENERATION

Lu and Tsai 2004 states that “organizations have to focus on the creation of knowledge to prevent existing knowledge from becoming obsolete quickly”. Knowledge generation means the knowledge acquired by the firm as well as that developed within it. The most direct way that firms use to acquire knowledge is to buy it - that is to buy an organization or hire individuals that have it. In addition to being purchased, outside knowledge is usually leased or rented (Fontaine, 2006). By far the most common process by which knowledge is generated in MNRCFs is through fusion between knowledge networks. Networks of knower’s, usually talk together in person, on the phone, and via e-mail and use groupware technologies to share expertise and solve problems together.

4.2. KNOWLEDGE ORGANISATION AND DEVELOPMENT

Common practice is for knowledge codification projects to have more specific aims than just making knowledge generally available (Beerli, Falk & Diemers, 2003). Mapping corporate knowledge sources is an important part of the knowledge organisation process. Once knowledge is found, someone must evaluate it to assess its usefulness and importance to the organisation, and to determine its type (Mika, 2006). Knowledge maps, pointing to people or documents and databases, are widely used in order to provide pointers to sources of knowledge (Beerli, Falk & Diemers, 2003).

Organising the richest tacit knowledge in MNRCFs is limited to locating someone with the knowledge, pointing the seeker to it, and encouraging them to interact while providing the necessary technological aids to enable a rich communication (Beerli, Falk & Diemers, 2003). The assembling of virtual teams to work on a project also addresses the same issue. Multimedia computing and the hypertext capabilities of intranets provide the capability of effectively capturing at least some meaningful fraction of an expert’s knowledge, making tacit knowledge explicit (Fontaine, 2006). Mentoring or apprenticeship is often seen as way to transfer tacit knowledge from one person to another (Caldwell, 2006). Another effort to support primarily organisation of tacit knowledge are the communities of practice (Fontaine, 2006). Communities of practice are also used for knowledge sharing, innovation, and capturing of opportunities by the employees in the specific areas (Mika, 2006). An identified challenge is the very loose coupling of the processes that produced the highly structured, explicit knowledge with the owners of the tacit knowledge (Heller-Schuh&Kasztler, 2005). In most cases, the management of tacit and explicit knowledge was not addresses in a holistic manner (Beerli, Falk & Diemers, 2003).

5. Knowledge Distribution

Transferring knowledge through personal conversations is being threatened by the increasing mobility of the consultants in MNRCFs. Field consultants who work daily on the site are less likely to pass on knowledge and insight on clients and problems handled to their colleagues. Information technology, and in particular intranets and Lotus Notes-based applications are seen as substitutes to personal communication although they lack the idea generation capability and serendipity of personal, face-to-face conversations (Heller-Schuh & Kasztler, 2005).

Tacit and ambiguous knowledge is especially hard to transfer from the resource that creates it to other parts of the organization (Heller-Schuh&Kasztler, 2005). Some consultancies are addressing this challenge by putting knowledge into circulation and transferring people in and out of the dedicated resource (Mika, 2006). Knowledge managers for example, can spend a period of time in one domain helping to generate new knowledge before they are replaced by newcomers. However, there exists a challenge for most MNRCFs to make knowledge distribution an easier and, if possible, transparent process: Consultants should be faced with the minimum possible overhead in sharing the knowledge gained in assignments with their colleagues.

6. Social Networks

Social networks are based on the idea that there is a determinable structure to how each person is connected to another, whether directly or indirectly (Churchill & Halverson, 2005). Social network

consider new means through it an organization members share information, communicate and collaborate among others (Seufert et al, 1999). The term “Social Network”, can be interpreted as the social structure between actors, mostly individuals or organizations, as well as between collectives of organizations, communities or even societies (Churchill & Halverson, 2005). A “Social Network” can be seen as: “a specific set of linkages among a defined set of actors, with the additional property that the characteristics of these linkages as a whole may be used to interpret the social behaviour of the actors involved” (Seufert et al, 1999). Social Network Analysis (SNA), a key technique in many modern research fields such as sociology, anthropology, social psychology and organizational studies, analyzes social networks through network theory, which views social relationships in terms of nodes and ties (Churchill & Halverson, 2005).

Within the MNRCFs, social network concepts have become increasingly interesting to many companies, since the evolution of network relationships within and between firms affects them (Seufert, Grogh& Bach, 1999). Social networks are used to examine associations and connections between individual employees, as well as how companies interact with each other. SNA helps MNRCFs to understand how people communicate and cooperate and to identify knowledge flows at the intra-organizational level as well as the inter-organizational level (Seufert et al, 1999). Several MNRCFs are offering services based on SNA, promising optimization of information flow as a way to improve efficiency, reduce costs, and improve productivity.

Enterprise social networking appears to refer to social networking sites designed for the enterprise, which emulate much of the functionality of social networking sites (Razmerita, Kirchner and Sudzina, 2009). Enterprise social networking tools offer community and collaboration features like profiles as a core component, blogging, bookmarking, RSS, wikis, and the creation of self-defined, self-managed online communities (Razmerita, Kirchner and Sudzina, 2009).

6.1. IMPORTANCE OF SOCIAL NETWORKING IN KNOWLEDGE MANAGEMENT

Social networking among employees constitutes the backbone for tacit knowledge sharing. Moreover, social networking is pertinent to knowledge management because of the following two reasons [Seufert, Grogh& Bach, 1999]. First, knowledge management should comprise a holistic view of knowledge, that is to say, the integration of explicit and tacit knowledge. Secondly, knowledge management should comprehensively regard where or rather how knowledge is being created and transferred (Seufert, Grogh& Bach, 1999). To focus on explicit knowledge only, or still to take a confined view of work, learning and innovation areas would incur the risk of erecting barriers of various kinds, functional and hierarchical. Barriers to knowledge management should be overcome by “networking”, and knowledge islands should be cross-linked in order to stimulate the evolution, dissemination and application of knowledge (O’Riain, Zhou, Li, O’Sullivan, Croke&Precup, 2006). Taking advantage of social networks in order to improve organisational knowledge management is a highly demanding task that involves, among others, understanding their inhibitors and levers, and establishing a set of clearly defined roles and expectations (O’Riain, Zhou, Li, O’Sullivan, Croke&Precup, 2006).

6.2. CHARACTERISTICS OF SOCIAL NETWORKS

According to Seufert, 1999, the main characteristics of social networks are related to the nature of the relationships formed within them, the network shape and the mechanisms and forces which affect networks development: The relationships between network actors are founded upon personnel organizational or technical-organizational interconnections on a long term basis and can be understood as deriving from their autonomy and interdependence, the coexistence of co-operation and competition as well as reciprocity and stability (Dawson, 2000). The relationships evolving between actors of social networks can be categorized according to contents (e.g. products or services, information, emotions), form (e.g. duration and closeness of the relationship) and intensity (e.g. communicate on frequency) (Heller-Schuh& Kasztler, 2005). The form and intensity of the relationships establishes the network structure.

The shape of the social network is a determining factor for the network’s usefulness to its individuals (Logan & Austin, 2006). Social networks with a lot of connections to individuals outside the main network are more useful to their members than smaller, tighter networks, because the participants of “open” networks have access to a wide range of information and therefore are more likely to have new ideas and opportunities (Caldwell, 2006).

Social networks can result through internalization or externalization (Woods, 2003). Internalization means an intensification of cooperation, while externalization is a limited functional outsourcing, which is reached by loosening hierarchical co-ordination mechanisms (Mika, 2006). Both internalization and externalization may take place at the same time within a company (Woods, 2003). Moreover, they can occur not only horizontally, i.e. on the same level of the value chain, but also vertically between actors on different levels of the value chain, e.g. between suppliers and customers (Mika, 2006).

Social networks within MNRECFs assembled to accumulate and use knowledge mainly by means of knowledge creation and transfer processes, for the purpose of creating value, i.e. knowledge networks, can be informal as well as formal (Beerli, Falk & Diemers, 2003). An informal networks is a loosely-knit group consisting of individuals who share a common interest and comes into existence bottom-up (Fontaine, 2006), while a formal network represents a group of people having a specific issue or a problem to solve occurs as a result of a specific goal and its development is prompted by the management (Wenger McDermott & Snyder, 2002).

6.3. KNOWLEDGE MANAGEMENT TOOLS SUPPORTING SOCIAL NETWORKS

Microsoft SharePoint has over 100 million users and offers social networking system capabilities, including the ability to selectively establish relationships between contacts and to grant permission to view selective information posted by users (Klein and Myers, 1999). Users can create a profile page that includes their job location, experience, and contact information (Klein and Myers, 1999). SharePoint can be used as a collaboration tool in a single organization as well as across organizations. It also integrates with other commonly used Microsoft tools such as Microsoft Outlook, thus supporting communication and collaboration between employees. It can be used to collaborate both internally between staff members and externally with clients (Klein and Myers, 1999). The SharePoint site is a repository of information regarding projects and is a key component of the project management process (Klein and Myers, 1999). MNRECFs use SharePoint as an integral part of their social networking and knowledge management systems, but it's just one example of the type of tools available to organizations for collaboration, knowledge management, and social networking. Similar tools that can foster social networking include Social text and Jive Software (Fischer and Ostwald, 2001). Knowledge management platforms including SharePoint, wikis, and a company portal for collaboration and social networking can help teams work together across different time zones and geographic locations while performing extensive research and development tasks (Levin and R. Cross, 2004).

In addition to SharePoint, some MNRECFs use Yammer, a social networking site designed specifically for internal use in an organization (Levin and R. Cross, 2004). For MNRECFs with employees scattered throughout the world Yammer can be used to help employees keep in touch and to foster a sense of community. Some of the posts on Yammer are personal in nature, but the vast majority is specific to work projects. Employees in MNRECFs frequently use Yammer to get assistance and ideas on how to improve their projects (Alavi and Leidner, 2001).

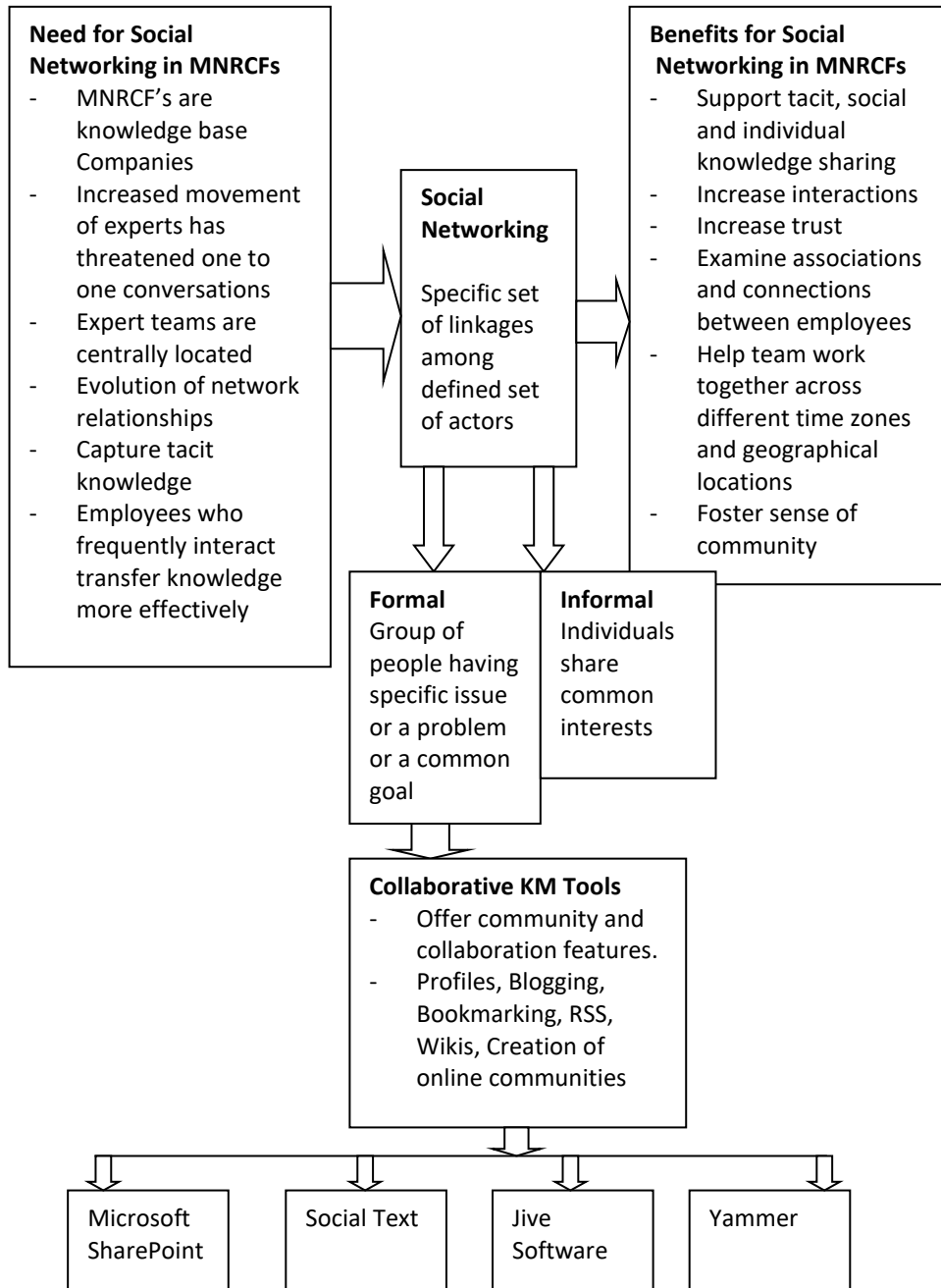

Figure 1, Framework – Social Networking in MNRCFs

7. Conclusion

In the modern, knowledge-based economy, hardly any company remains unaffected by the evolution of network-like relationships within and between firms (Harris, 2006). The complexities in tasks and the demand for creative work from the workers have shifted the style of work from, historically, one of coordination and cooperation to collaboration and the management’s focus from the traditional “process-based” framework to a “teams-based” network structure [Tsui, 2002]. Employees MNRCFs belong to multiple organization units or even organizations and work in dispersed locations and therefore, they have a strong requirement for flexible and easy to deploy collaborative KM tools [Tsui, 2002]. While in the last years comprehensive sets of tools including a mixture of different technologies supporting communication have increased, the individual components are not always well integrated [Harris, 2006]. Since the trend grows among users who are seeking to support a broad range of collaboration capabilities for the purposes of collaborating and sharing knowledge, the integration of collaboration technologies is vital [Harris, 2006].

8. Recommendations

Social networking systems pose conflicting challenges by pitting privacy concerns against the ease of managing knowledge (Levin and R. Cross, 2004). Although such systems might motivate employees to contribute knowledge by developing a sense of community, the inherent complexity of setting security policies and controlling the visibility of knowledge managed through these systems poses a significant challenge to organizational adoption (Alavi and Leidner, 2001). Organizations need mechanisms to protect information without prohibitive restrictions that could dissuade use (Fischer and Ostwald, 2001). The more democratic characteristics of social networking systems must be balanced with organizational hierarchies and access control (Levin and R. Cross, 2004). For example, restricting the user base for the social networking system might be an easy mechanism to protect data privacy, but it could inhibit wider adoption and open contribution (Alavi and Leidner, 2001). Assigning ownership of specific sections to key stakeholders.

9. References

- Alavi, M, &Leidner, D, "Knowledge Management and Knowledge Management Systems: Conceptual Foundations and Research Issues," *MIS Quarterly*, vol. 25, no. 1, 2001, pp. 107–136.
- Berli ,A, Falk, S, Diemers, D 2003, "Knowledge Management and Networked Environments. New York", AMACON.
- Caldwell, F, 2006, "Managing Philosophies and Risks when Knowledge and information Management Converge", <www.gartner.com>.
- Carlsson, A 2001, "Knowledge management in network contexts." *ECIS 2001 Proceedings* (2001).
- Churchill, E, Halverson, C 2005, "Social Networks and Social Networking". *IEEE Internet Computing*, vol. 9 (5), pp 14-19.
- Dawson, R 2000, "Developing Knowledge-Based Client Relationships", *The Future of Professional Services*, Butterworth-Heinemann.
- Deloitte 2013, *Real Estate Services*, United Kingdom.
- Drucker, P 1993, "Post-capitalist Society, Butterworth-Heinemann", Oxford.
- Fischer, G, & Ostwald, J, "Knowledge Management: Problems, Promises, Realities, and Challenges," *IEEE Intelligent Systems*, vol. 16, no. 1, 2001, pp. 60–72. 2.
- Fong, P, & Sonia, C 2009, "The processes of knowledge management in professional services firms in the construction industry: a critical assessment of both theory and practice", *Journal of Knowledge Management*, vol. 13 no 2, pp.110-126.
- Fontaine, M 2001, *Understanding, Identifying and Selecting the Roles Needed to Staff and Support Communities of Practice*, <http://openacademy.mindef.gov.sg/>
- Gupta J & Sharma S. 2003, "Creating Knowledge Based Organizations", Idea Group Publishing, Hershey, PA, pp. 185-202.
- Harris-Jones, C 2006, *Knowledge management past and future* , <www.kmworld.com>
- Heller-Schuh ,B, Kasztler, A 2005, "Analyzing Knowledge Networks in Organizations. Proceedings of I-KNOW" Graz, Austria, June 29-July 1, 2005.
- Klein, H, & Myers, M 1999, "A Set of Principles for Conducting and Evaluating Interpretive Field Studies in Information Systems," *MIS Quarterly*, vol. 23, no. 1, pp. 67–94.
- Laudon, C, & Laudon, J 2000, "Management Information Systems: Organization and Technology in the Networked Enterprise", Prentice-Hall, Upper Saddle River, NJ.
- Levin, D, and Cross, R, "The Strength of Weak Ties You Can Trust: The Mediating Role of Trust in Effective Knowledge Transfer," *Management Science*, vol. 50, no. 11, 2004, pp. 1477–1490.
- Logan ,D, Austin, T 2006, "Use Technology to Support Collaboration in KM Programs" < www.gartner.com>.
- Mika, P, 2006, "Social Networks and the Semantic Web: The Next Challenge", *Social Networks Applied, IEEE Intelligent Systems*, pp 80-93.
- Nissen, M 2004, "Inducing enterprise knowledge flows", in Gupta, J.N.D. and Sharma, S.K. (Eds),
- Nissen, M 2004, 'Inducing enterprise knowledge flows', in Gupta, J.N.D. and Sharma, S.K. (ed), *Creating Knowledge Based Organizations*, Idea Group Publishing, Hershey, PA, pp. 185-202.
- O'Riain, S, Zhou, X, Li ,J, O'Sullivan, Croke ,P, Precup ,L 2004, "Knowledge Management (Tools and Technologies)" ,<www.lion.deri.org>.
- Papailiou, N, Apostolou, D,&Mentzas, G2005, 'Social Networks for Knowledge Management in Management ConsultingFirms', <<https://pdfs.semanticscholar.org/64b1/98b1412b1e62fd77b6da369e6bd77d204969.pdf>>.
- Razmerita, L, Kathrin, K, & Frantisek, S 2009, "Personal knowledge management: The role of Web 2.0 tools for managing knowledge at individual and organisational levels." *Online information review*, VOL 33, no. 6, PP. 1021-1039.
- Seufert ,A, von Grogh, G, Bach, A 1999, " Towards knowledge Networking", *Journal of Knowledge Management*, vol. 3 (3), pp. 180-190.
- Seufert, A, Grogh, G, Bach, A1999, 'Towards knowledge networking', *Journal of Knowledge Management*, vol. 3 no 6, pp. 180-190.
- Swan, J 1999, "Knowledge Management and Innovation: Networks and Networking," *J. Knowledge Management*, vol. 3, no. 4, 1999, pp. 262–275.

- Tsui, E 2002, "Technologies for Personal and Peer to Peer (P2P) Knowledge Management". CSC Leading Edge Forum Technology Grant Report.
- Wenger, E, McDermott, R, Snyder, W 2002, "Cultivating communities of practice", Boston: Harvard Business School Press.
- Woods, E 2003, "Collaborative Software: evolution and revolution: Realizing the potential of the networked enterprise", <www.kmworld.com>

Samarawickrama, Sumanthri, et al (eds), 2018, "Sustainability for people - envisaging multi disciplinary solution": *Proceedings of the 11th International Conference of Faculty of Architecture Research Unit (FARU), University of Moratuwa, Sri Lanka, December 08, 2018* Galle pp. 17–24. ©

GENDER MAINSTREAMING IN URBAN PLANNING:

An exploratory study of women's perception on liveability in Keonjhar city, Odisha.

SWAGATIKA MISHRA, NEERAJ GUPTA & BHUMIKA SHARMA

Central University of Rajasthan, Kishangarh, India

2017phdarcho1@curaj.ac.in, swagatikamishra910@gmail.com

Abstract

Neighbourhood planning has always been considered as the key unit of any urban development. The origin of this term has been envisaged for a safe, resilient and inclusive society where in residents aim to engage well. However, due to the pressure of rapid urbanization and increasing housing demand, often neighbourhood planning fails to embrace the civic demands related to women residents. This paper explores women's perception on liveability in the residential neighbourhood with respect to the built environment and civic amenities. A case study has been carried out in two different wards of a tier-2 city, Keonjhar, the tribal city of Odisha which holds a unique cultural background. In this case study a questionnaire has been developed on the basis of six physical indicators which define the characteristics of the civic amenities provided in the neighbourhood that governs women's liveability. A sample of (n=30) women residents of three age groups being interviewed to explore the attributes associated with these indicators and how these are affected by the land use, spatial distribution and built environment. This paper aims to derive a gender sensitive framework on the basis of women's perception to plan better and safe residential neighbourhood, which will enhance the quality of life of women residents.

Keywords: *Gender, Perception, Civic amenities, Urban Planning, Neighbourhood*

1. Introduction

Along with the planning guidelines, a successful neighbourhood should also emphasize the human dimensions and their expectations to enhance the liveability.(Lynch,1998;Balsas,2004) The concept of neighbourhood which originated in the far west has been introduced into India post independence. It was expected to embed well because it was flexible enough to morph rightly with the indigenous cultural values of India (Vidyarthi, 2015). In due course of time many Indian planners have implemented this modern concept in planning new cities in India. However analysing today's situation, even planned urban areas have failed to meet the liveable qualities and are no more safe for the residents.(Jagori, 2016).The increasing rate of violence against women in public spaces urge for a gender sensitive approach of planning for built environment(Dhar,2016).

Generally residential neighbourhoods are planned with the simple notion to house the population wherein civic infrastructure is laid as per the given guidelines and norms. In absence of any clear notion about their spatial distribution, it is observed that there are few pockets which are amassed with the civic amenities and few portions of the neighbourhood are sparsely fed with the service.

In the planning of Bhubaneswar city, planner O. Koenigsberger introduced 'Neighbourhood Unit' with an expectation to create mixed communities which would call for a more inclusive and resilient society(Vidyarthi,2015; Kalia,1995). As the very first planned city of the state having come into being, it was expected to repeat the same ideology of planning for a few more emerging cities. But the core essence of neighbourhood planning which believed in safety of the inhabitants and its cultural adaptation was lost in the further process of planning. As indicated in the failure of steel city, Rourkela (Parida, 2017) the town planning of cities overlooked the need to incorporate cultural variation into the planning process.

The Town Planning Unit of Keonjhar was established and operated with statutory functions in the year 1990 after the 3rd five year plan (1961-64). In spite of being mentioned in the town planning manual the recommendation of civic amenities for a neighbourhood as per its population, the spatial distribution of civic amenities face rejection from the user's point of view. The same scenario has occurred in the city of Keonjhar making the places of activities almost inaccessible for the city women. The disorganised and lack of sensible planning of civic amenities are putting the female resident's in a disadvantageous condition by restricting their access. To establish and explore the women's perception towards liveability, a group of women (n=30) were interviewed from two different wards of the town with respect to the spatial distribution and availability of civic amenities.

2. Background study

Before plunging into the specific case study of an Indian town, it is apt to understand the overall conception of town planning and the factors, which led to the realization of its urgency and planned visualization. In the post industrial revolution era the western world faced the ugliest sporadic growth of cities giving rise to unhealthy environment and poor living conditions, which damaged the traditional ties of ancient civilization. This situation of human settlement pushed the thinkers to pause and think rationally about the betterment of the society and bring out new solutions. In 1920, New York planner C.A Perry had proposed the concept of neighbourhood unit which was repeated for almost seven decades as the most implemented planning principle. His proposal was mainly focused on residential communities arranged around a central place, where the school was sited along with the playground and a small convenient shop at the centre being the heart of the community. The whole arrangement was described in a way that it can be covered in 1/4th of a mile, a distance which is easily walkable for a child and is approached through safe pedestrian access. The relationship between various design elements of the neighbourhood concept can be seen as a multivariate scheme, derived from six principles: Size, boundary, open space, institution site, local shop and internal street system (Vidyarthi, 2015). The interdependency and spatial location of the activities played a major role in designing the neighbourhood. Also the hierarchy of roads controlled the traffic movement in and out of the neighbourhood.

Neighbourhood concept was not of scientific nature like any hypothesis testing but it was clear reflection of the modification in the past design experiences along with the prevailing thought process of Perry's era. On the basis of this development there emerged a new cultural and intellectual belief exhibited in the opinion of some American reformists of that period. (Banerjee and Baer, 1984) After the mass acceptance of the concept as a standard in American planning society, it started reflecting in the other parts of the world with some modifications and creative amalgamation of many native ideas of planning. In India also neighbourhood concept started gaining recognition not as a slow sinking but as a sudden change.

Post-independence, India faced a challenge in terms of town planning to adopt a new philosophy which can liberate Indian planning from British colonial watermark. It was the first Prime Minister Nehru who advocated introducing modern concept of planning through which Indian cities would flourish in an organized set-up. The first planned city, Chandigarh was set as an example to break the stereotypic conception of colonialism and for both Nehru & Le Corbusier it appealed that machine age would be responsible to improve the society (Kalia, 2006). Unlike Chandigarh, Bhubaneswar, the planned city in Odisha rose as a conflict between the traditional Odia temple culture and modern secularism.

Before Koenigsberger took charge of designing the capital city Bhubaneswar, it was supposed to adhere to the philosophy of Julius Vaz whose main intention was to organize a settlement reflecting local character. So it was a complex task for the planner to draw a master plan which would deliver modern amenities mentioned by the bureaucrats, still retaining the medieval traces. Besides, it was also expected to fulfill the dream of a capital city of Odia people (Kalia, 1994). Koenigsberger also realized the composite character of the place and subsequently suggested for a mixed society practicing different profession which would give rise to a great economy and cultural diversity. He emphasized to create a neighbourhood unit with a residential area large enough to afford modern amenities but, at the same time, maintaining a walkable distance to provide the feel of a village where people have better civic responsibilities. These units were designed with the facilities reinforced specifically keeping in mind

the requirements of children and women. But the decision of making a horizontally expansive city accentuated more motorized transport which could not support a walkable neighbourhood.

Koenigsberger did not emphasize on the shopping activity and the location which was contradictory to Indian practice of “Bazaar”. There are many more instances, due to the planner’s thought process the western prototype could not fit well to the Indian context, like that of in Keonjhar.

The Town Planning Authority for Keonjhar was constituted by appointing Special Planning Authority in 1981. The Planning process was expected to deal with the territorial challenges and unique socio-cultural background of Keonjhar city.

Keonjhar is a mining city in Odisha with large area of land under the forest belt due to the influence of the neighbouring districts which are majorly identified as tribal areas (Mayurbhanj, Sundargarh of Odisha & Shinghbhum of Jharkhand). Thus the impact of a high cultural amalgamation is quite visible in the language, food habit, culture, rituals which affects the acceptance of social changes. As per the state Town Planning Act, the city master plan has been prepared to make provision for planned development, expansion & improvement of the city but there is a gap in terms of serving the local populations’ needs and spatial distribution of civic amenities. As quoted by Peter Grenell (1980) Planning being essential for decision making, it is essential to know what it can deliver and what it can’t, which outcomes are culture-specific and what can be absorbed by a society.

As argued by Chris Maser (2010) each community has its unique cultural, physical and political identification which makes the community adaptive or revolting to new changes. The deciding factor on which sustainability of a community depends is the flexibility of its cultural adaptation. Hence it is essential for plans to cater to the cultural practices of the community. As Keonjhar is driven by a more introvert cultural set up compared to the capital city, it is mandatory for the planning professional to gain the knowledge of its cultural transformation and the cultural carrying capacity to design the built environment.

Keonjhar is the 11th urbanized district of Odisha having 14.05% of its population living in urban areas. The female population in the district is 49.6% and the female literacy rate is 58% against 78% literacy in men. Also as per the census data for labour force participation, the percentage of female participation in non-workers category is 70.02% of the total non-workers population. This validates strongly that women’s perception plays an important role in shaping up the planning & provision of civic amenities in the city of Keonjhar which will lead to more female participation in the labour force.

There has been adequate amount of literature which advocates the present planning scenario is gender neutral which puts women in disadvantage position in the society, hence there is a need of gender sensitive approach in planning and designing. Due to rapid urbanization where there is enough stress on affordable housing, efficient transportation network and planned infrastructure, spatial planning has lost its focus which affects women’s quality of life.

Along with the reproductive & care taking responsibilities, women today have moved forward to a more dynamic life like participating in the country’s economy. Due to this added duty, women have to travel the work place which is not always closer to the shelter, making things difficult.

Women even with the appropriate skills and exposure often choose not to be part of the work force due to the unfair travel time between work and shelter and erratic spatial arrangement of civic infrastructure which consume most of their time in fulfilling the basic responsibilities (Kunieda, 2007). Women both working and non-working have the responsibility of family and thus their mobility pattern and the choice for mode of transport is highly influence by the social construct. The daily trip pattern for a woman is multimodal, short and mostly walkable which is very different from men (Tiwari *et al.*, 2014). To point out accurately, Gopalan (2005) has argued, social construct in many community restricts women’s movement which affect her accessibility to resources. Even in their own residential neighbourhoods where women are expected to have freedom of movement, due to unreasonable travel distance and location of activities makes it difficult to pursue. Moreover the safety of women has been

challenged frequently in public realm. As per the study of Jagori(2009-2010), streets and public transports are reported as the most unsafe places for women. Hence due to the fear of being a target, women found it difficult to access resources which are available for them.

The elements of built environment like, the residential density, street network, landscape, market places and their positive attributes are directly proposal to the liveability of women (Foster, Giles-Corti and Knuiman, 2010).The location of school, park, market, transportation means and their hub decides the viability of the neighbourhood. Like mentioned earlier also, the planning guidelines do not provide for spatial distribution of amenities and it is left to the planner.

As per URDPFI guidelines, the classification of roads have followed the hierarchy of traffic carrying capacity. However, while planning essential details like the length of roads, treatment of side edges, pedestrian pathways etc is often missed out. Similarly, for the educational facilities, the norm has emphasized the site next to a play ground or park, but the spatial location of the school with respect to the residential neighbourhood is not defined.

3. Case study

It is always discussed in any master planning process, that public participation plays an important role in decision making. Urban design should involve a dialogue between the planners and users who hold the knowledge of how an existing area works, about its needs & possibilities. (Mumford, 2015). However, in most of the cases it doesn't happen due to various reasons including lack of awareness among public and disinterest of the planning agency. Public participation is often done by the planning agencies to fulfil the statutory requirements of the approval process rather a serious commitment to take inputs from various stakeholders. Unless users' perspective is taken into account in early stages of planning it is a challenge to incorporate the user's aspirations. This creates a planning monolith which doesn't offer multiple choices for the users. In order to understand the perception of women about the available civic amenities it is critical to recognize their special requirements first which can help improve their quality of life.

As described before the case study is carried up in Keonjhar district in two different wards, ward no-12 (population- 2109) & 13(population- 2353) which are located in the centre of the town. Due to the central location of the wards, it is expected to avail all the amenities without any difficulties. However, it is not true for the very obvious reason of their location, land use, characteristic of the built environment and the influence of socio-cultural aspect. As per the different types, the available civic amenities are categorised in basic three different divisions i.e. (i) institutional, (ii) commercial, (iii) recreational. Each amenity was evaluated on the basis of availability, safety and accessibility which control women's choices.

Apart from the questionnaire interview, few observations were taken into account to understand the urban characteristics of the build environment. Each dimension and their indicators are evaluated on the basis of few observational inputs like presence of 'guardian eyes', length of the approach road from the shelter, abandoned sites near the activities, loitering of men around the public places, absence of activity generators, presence of activities which creates imbalance in urban mix, illumination level at public places and access roads, traffic movement in and around neighbourhood, abandoned routes or spaces. These are the reasons which are responsible for the decline of the public places.

3.1 INSTITUTIONAL AMENITIES

As to serve the population of the neighbourhood there are four schools in close vicinity which falls in a range of 700m radial coverage distance. However it takes more than 15-20 minutes for a child to walk to the school. In absence of proper hierarchy of roads and thus, many internal roads become channel of through traffic. Hence, the pedestrian route taken by schoolchildren is not different from vehicular movement. This becomes a matter of concern for the mothers and they are constrained to accompany their children as they walk to and from the school.

Moreover, it is observed that the access road to the school has negative characteristics like high boundary walls without any punctuation which does not allow any watching eye on the street. As crimes

are opportunistic in nature when people are engaged in their daily activities when they find a potential target (Foster, Giles-Corti and Knuiiman, 2010), these kind of poorly designed built spaces create a niche for entrapment (Prevention, Environmental and Guidebook, 2008).

Crime is directly associated with the absence of natural surveillance (Jacob, 1992). 90% women who responded to the survey identified similar streets and spaces where they do not prefer to travel to avoid being a potential target.

Near the school zone a daily market set up adds traffic stagnation and it increases on weekends. The limited road width is incapable to allow traffic flow amidst the informal sector street market. This poses additional safety hazard for school going children.

As per the requirement (URDPFI guidelines) there should be a play area associated with the school, where children can pursue their recreational hobbies in leisure time. In many cases, due to the prime location of the school it becomes difficult to accommodate a fairly spacious play ground in the premises.

3.2 PARKS AND RECREATIONAL AMENITIES

Appropriate location and design of parks and open spaces is important to ensure their use by all sections of the society. A study in Vienna revealed that most of the girls in growing stage drop out pursuing physical activity (Urban Development Vienna., 2013) due to lack of any special zoning in play field which would give them a sense of their own space.

Recreational desires have extended in recognition of the fact that satisfactory leisure experiences can contribute to self-fulfilment (Broeck, 1984). Hence the user's expectation demands a recreational space with multiple choices and facilities to fulfil their leisure need.

In Keonjhar town there is only one town park provided at the centre of the city assuming it will satisfy the need and enhance the quality of life. As per the study area, this park is located in the radial distance of 1.2km which is far from the residential area. The distance of the park is not easy to travel for a child, as one has to cross the heavy vehicular zone of the city. Accompanying own's children on everyday basis for recreational pursuit is a tedious affair for the women of the neighbourhood. As parents of adolescent girls want to keep an eye on them for safety concern (Urban Development Vienna., 2013), they do not prefer their children to travel far, where they are susceptible for victimization.

Even mothers of small children feel at ease when they find their kids playing in the range of their eye spot and ear spot. Hence, it results in converting open spaces or streets in close vicinity of their homes, to recreational area. This allows parents to have easy natural surveillance. Spaces if not designed as they are designated, get converted or modified as per the user's demand (Prevention, Environmental and Guidebook, 2008). So the spaces encompassed by the cluster tend to serve as play area for kids of the vicinity extending a hand to fulfil their recreational need. Thus, the mothers have no choice but to compromise with the quality of spaces available while choosing the safety factor.

The internal planning of the sole recreational park of the city, in absence of zoning divisions for different users offers a few handfuls of choices for users. Play equipments are haphazardly placed leaving no space for any other field game. There is no hierarchy of spaces for different age group activities where zoning preferring gender sensitive approach is a phantasm. A zoning segregating for the gender neutral games and the gender preferred games would actually enhance the usage of the park allowing more users of both the sexes. Moreover if spaces would be assigned keeping in mind different age group women it would result attracting more female users by their choice and not by obligation. This will also allow elderly grandparents observe their grand children playing while they can resume their physical activities.

Most of the respondent of growing age (11-20) responded asking for safe, separate zones in the park with natural surveillance which will attract the female users to participate actively in pursuing physical or even cultural activities. Due to lack of preference in spaces they choose to stay at home compromising

with the available resources. Even due to the social construct and introvert society, it does not give a free hand to the female to go far from home for sports and games.

3.3 COMMERCIAL AMENITIES

This is one of those amenities which is more frequently used by the female residents rather than the men to take care of the needs of the family. The nearest planned shopping centre falls in the radial distance of 600m which offers a limited choices of products. The central market area is beyond 1.5km of radial distance from the target neighbourhood. Moreover, the mode of transportation which is para-transit in nature is not readily available near the neighbourhood at any point of time. So to avoid unnecessary expense women take a trip by walk (Kunieda, 2007) at the cost of their safety by crossing heavy traffic zone.

Even the permeable street layout where there is less variation in traffic movement makes the walkability of old women and young females more vulnerable to violence. Though women feel little safer at 'encounter zones'(Foster, Giles-Corti and Knuiman, 2010) but as they go farther from public realm, the poor illuminating quality of roads makes its worse to walk safely. The absence of safe pedestrian footpath, the edge condition of roads, encroachment of informal sector and lack of segregated lanes for pedestrians and vehicular traffic movement creates additional challenges for women of all age to access the resources.

Inside the residential neighbourhood small shopping outlets are located to accommodate the need of day-to-day demand which is again not approachable easily due to the loitering characteristics of men around it. The proximity of the convenient store to the shelter allows stranger's presence near that area, hence enhancing the fear of crime.

As per literature it is stated that people living closer to daily shopping areas which are surrounded by strangers, endangered female's life enhancing the chance of victimization(Foster, Giles-Corti and Knuiman, 2010). Hence proximity of activities and the adjacent land use affects a lot on the quality of life, depending on its positive or negative characteristics. Adjoining to these convenient shops, vacant plots are there which detach the association of natural surveillance abruptly creating a sense of fear.

As per the survey, many college girls reported that they do not feel safe go outside after dark and avoid routes where there are more men loitering. Hence, there are design discrepancies resulting spaces which enhance unsocial activities affecting the mobility of women in the neighbourhood.

3.4 SOCIO-CULTURAL BACKGROUND

Every culture makes the difference between social system and environment, inclusion or exclusion or between social expected behaviour and social deviance(Brocchi, 2014).Keonjhar city stands out as a distinct cultural set up due to the influence of native Ho tribe is a branch of Munda which forms an eminent part of the total tribal population(44.5%) of the district(Census, 2011).This tribe belongs to austro-Asiatic lineage ('Tribes of Orissa', 1990) lives in the villages and forests of the district.

The daily goods market of Keonjhar is heavily dependent on the tribal people for the availability of fresh hand-picked items from the forest which gets an upper hand over the modern super-market. However the space allocated for putting up such markets is inadequate and is far from the heart of the city, this makes it difficult for women of nearby villages to commute. Hence they end up spreading their merchandise on the main road and this restraining the smooth flow of traffic. It would be of great help if few permanent planned spaces will be provided in the central area of the market which will not affect the traffic movement, allowing the villagers to earn their livelihood and serve the needs of the local residents.

As a daily activity, these tribal people are used to prefer alcohol as part of their routine life. Hence the neighbourhood is located with small liquor outlets which become hub of unsocial activity after the sunset. The open spaces seem to get transformed to open pubs changing the character of the place and making them unsafe. This terrifies women from the nearby neighbourhood to pass this area while travelling alone or even in groups. Quite clearly many of these issues are related to city management

and can be easily implemented by shifting the location of liquor shops away from residential areas.

4. ANALYSIS

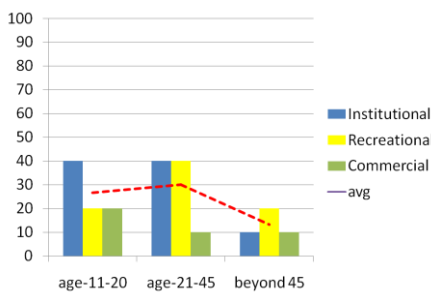

Figure1. Spatial suitability

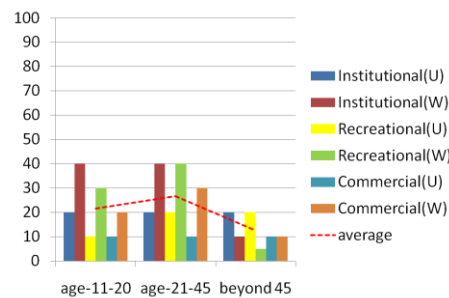

Figure 1. Accessibility as per urban mix and walkability

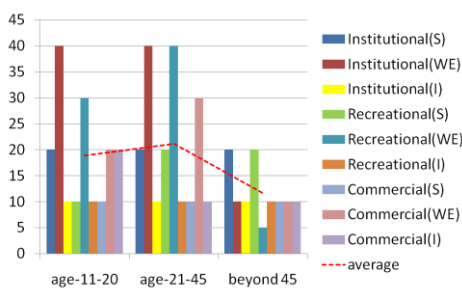

Figure 3. Safety as per street network, watching eyes and illumination level

In the study we have considered three basic dimensions i.e, availability of resources, accessibility of resources and the safety factor which influence women’s liveability.

The study reveals that the availability of the amenities plays an significant role which again becomes difficult to access due to the In this context, it was found that the availability of the amenities plays an significant role which again becomes difficult to access due to the lack of foresight in spatial planning. Moreover, the characteristics of the physical environment, which are not designed as designated, make the conditions worse in terms of accessibility of the resources.

5. Conclusion

City design is a game of all the stake holders in the same arena with fair shares and responsibilities. Every city has its own cultural story which people want to remember their whole lives and celebrate it though their life style. Hence it is essential for planners to collect the knowledge about their socio-cultural background and draw out the expectations of the residents keeping in mind their cultural need. Looking at today’s scenario where women’s life has been drastically changed and so their expectations from the civic amenities, this is the call of time for the planners to shift the focus towards gender sensitive approach of spatial planning which will improve the quality of life for all.

References

Banerjee, T. and Baer, W. C. 1984, *Beyond the neighborhood unit : residential environments and public policy*. Plenum Press.

Brocchi, D. 2008. *The cultural dimension of sustainability*. In S. Kagan & V. Kirchberg (eds.), *Sustainability: A new frontier for the arts and cultures* (pp. 26-58). Frankfurt am Main: VAS (Verlag für Akademische Schriften).

Broeck, B. K. Ten 1984, ‘Who uses our parks ? | An evaluation of the application of standards-based recreation planning methods for assessing neighborhood park needs in urban Missoula , Montana’.

Census 2011, ‘Jalor District census handbook’.

- Chris, M. 2010, *Social-Environmental Planning: The Design Interface Between Everyforest and Everycity*, U.S: CRC Press.
- Dhar, S. 2018, *Gender and Sustainable Development Goals*, Indian Journal of Gender Studies 25(1):47-78
- Foster, S., Giles-Corti, B. and Knuiiman, M. 2010, 'Neighbourhood design and fear of crime: A social-ecological examination of the correlates of residents' fear in new suburban housing developments', *Health and Place*, 16(6), pp. 1156–1165. doi: 10.1016/j.healthplace.2010.07.007.
- Gopalan, P. 1998, *Circumscribed Existence: Women's mobility and settlements development*, In SUSTRAN Network General Assembly, Mumbai: Swayam Shikshan Prayog - SSP.
- Grenell, P. 1980, *Planning the new Capital of Bhubaneswar* in Susan Seymour (ed), *The Transformation of a Sacred Town: Bhubaneswar, India, USA* :Westview Press.
- Jacobs, J. 1992, *The death and life of great American cities*, New York: Vintage Books
- Kalia, R. 1995, *Bhubaneswar: From a Temple Town to a Capital City*, Delhi: Oxford University Press.
- Kunieda, M. and Gauthier, A. 2007, 'Gender and Urban Transport : Smart and Affordable', *Sustainable Transport: A Sourcebook for Policy-makers in Developing Cities*, Module 7a(September), Germany. Available at: <http://www.sutp.org>.
- Mumford, E. 2015, 'Urban Design', *The Josep Luuis Sert Writings*, pp. 34–40.
- Parida, D. 2017, *Planning in Steel Towns in Postcolonial India: A case of Rourkela Climate responsive design: a study of buildings in moderate and hot humid climates*, Institute of Town Planners, India Journal, New Delhi, 64-75
- National Crime Prevention Council. 2003, *Crime Prevention Through Environmental Design*, Singapore
- 'Tribes of Orissa' 1990.
- Urban Development Vienna. 2013, *Legal Notice : Manual for Gender Mainstreaming In Urban Planning and Urban Development*.
- Tiwari, G. 2014, *Planning and designing transport systems to ensure safe travel for women*, International Transport Forum Discussion Paper, No. 2014-04
- Vidyarathi, S. 2015, *One Idea, Many Plans: An American City Design Concept in Independent India*, New York: Routledge

Samarawickrama, Sumanthri, et al (eds), 2018, "Sustainability for people - envisaging multi disciplinary solution": *Proceedings of the 11th International Conference of Faculty of Architecture Research Unit (FARU), University of Moratuwa, Sri Lanka, December 08, 2018* Galle pp. 25-33. ©

LANDSLIDES PREDICTON BASED ON NEURAL NETWORK AND REMOTE SENSING DATA

L. D. C. H. N. KALPANA¹ & L. D.C. S. SUBHASHINI²

¹Unisersity of Moratuwa, Moratuwa, Sri Lanka,

² University of Sri Jayewardenepura, Nugegoda, Sri Lanka,

¹1523161@uom.lk, ²subhashini@sjp.ac.lk

Abstract

Landslide is one of the main natural disaster that Sri Lankan intermediate zone faced. In most of the cases, property damage and vulnerability of people significantly high compared to the other natural disasters. This mainly occurs due to poor disaster forecasting methodologies, lack of early warning systems and preparedness practices. Therefore there is a vital need of implementing a model for landslides prediction. In this research, it supposed to introduce landslide forecasting model based on remote sensing methodologies and Artificial Neural Network (ANN). Landslide forecasting modelling has long history in many countries and most of the scenarios it was based on the trend line analysis, and liner and non-liner regression analytical methods and models. Remote sensing methodologies and technics are doing significant impact on landslides disaster evaluation and mitigation process in multiple sectors. Normalized Difference Vegetation Index (NDVI) has shown powerful calculation remote sensing techniques to identify vegetation, soil and build-up areas and significant variations of them through the raster calculation methods. Hence, these factors were rarely use in existing landslide forecasting models. This research is identified the significance of these calculations on landslide forecasting using ANN model with NDVI. The model was evaluated using a baseline model. The results of the model expose ability to increase the accuracy than existing landslides forecasting models.

Keywords: *Artificial Neural Network (ANN), Normalized Difference Vegetation Index (NDVI)*

1. Introduction

Landslide is define as earth soil structure moved from its top to bottom due to loss of soils friction. This can be occurred due to several phenomenon and can be categorized as manmade and natural causes (Weerasinghe & Malalasekara, 2008). As manmade scenarios it can be occurred due to the constructions of hill areas, deforestation, resettlement and mining and the other way as the natural phenomenon it can be occurred due to the earth quake, heavy rain, wind, and topology and terrain system (Bandara, 2005). The particular movements of the soil structure occurred in several ways such as fall, topple, slide, spread or flow. This mass movement vulnerable to generate disasters and caused to the death of people and property losses (Bandara, 2005).

In the Sri Lankan scenario Landslide can be identify as one of the main disaster which faced by the central highlands of the country during the rainy season such as Watawala landslide in 1992, Hela Uda landslide in 1993, Naketiya landslide in 1997, Mulhalkele in 1986 and Elapatha, Abepura landslide in 2003 (Weerasinghe & Malalasekara, 2008). This threaten loss of lives and damaging the property and having a significant impact on the country's economy. In most of landslide occurrences, property damage and vulnerability of people significantly high compared to the other natural disasters. This mainly occurs due to poor disaster forecasting methodologies, lack of early warning systems and preparedness practices of the people. For the occurrence to the landslide there can be impact several phenomenon such as topology, terrain, aspect, curvature and the type of the soil particles of the ground which vulnerable to the landslide.

Researchers were developed (Subhashini & Premaratne, 2013) Landslides prediction models using ANN and GIS. However the accuracy is still low due to the factors that were considered in the models. Considering the probabilistic landslide hazard mapping using GIS and Remote Sensing data used topographic, soil, forest cover, slope, aspect, curvature, texture, material, drainage and effective soil thickness as its considering factors. But most of the data are outdated and have gathered from the countries topological database but not the real-time surveys or remote sensing technics. Hence the particular research does not considered the vegetation change impact and the build-up area change impact to the landslide vulnerability which consider in higher level in this particular proposed research (Lee, Choi, & Min, 2004). Considering the landslide forecasting modelling has long history in many countries and most of the scenarios it was based on the treadling analysis, and liner and non-liner regression analytical methods and models (Lee, Choi, & Min, 2004).

In this research, it supposed to introduce landslide forecasting model based on Remote Sensing methodologies and ANN. The model identified input as NVDI, distance from roads, distance from channels, aspect, slope, profile curvature and slope curvature. This model interstates GIS and ANN to increase the accuracy and evaluated on one baseline model of (Subhashini & Premaratne, 2013) with regards to accuracy. However, ANN and GIS shows significant accuracy and the predictions which made on shows high accuracy compared to the actual ground scenarios and most of the time model is flexible to use in environmental based modelling with high significance level.

The proposed model provides valuable insights for landslides prediction. The government can use this knowledge to as early warning system for landslide prediction. This paper is organized as follows: Section 2 presents Related Works, Section 3 Data Collection and preparation, and Section 4 Methodology and Results. Finally, Conclusion is discussed in Section 5.

2. Related Work

Considering the Sri Lankan topology and the tropical weather condition there can be identify diverse environmental hazards are occurred due to many environmental and manmade reasons with the diversify terrain system, environmental system and the weather condition (Bandara, 2005). Mainly Sri Lanka can be divided into three climatic zones namely dry zone, wet zone and the intermediate zone (Bandara, 2005). Most of the time landslide vulnerability is impacted on the intermediate zone in the country due to high elevation and the topology and climatic condition of the area (Weerasinghe & Malalasekara, 2008). High precipitation level, informal construction, agricultural pattern and neighbourhood development in environmental sensitive areas has risen the impact of the landslide occurrence and its vulnerability. Therefor some research institute (NBRO) and government departments have demarcate some areas in the intermediate zone as landslide potential areas such as Matale, Kandy, Nuwara Eliya, Badulla, Kegalle, Ratnapura, Kalutara, Galle, Matara and Hambantota (Weerasinghe & Malalasekara, 2008).

Landslide forecasting modelling has long history in many countries and most of the scenarios it was based on the Univariant probability analysis–likelihood ratio method (Lee, Choi, & Min, 2004), This methodology refers the past occurrence of the landslide and measure the probability to occur future landslide with the same module situation and its probability will be differ with its likelihood level. “A landslide occurred in the past because of a landslide-related factor, and future landslides will occur because of the same factor” (F, Chung, & Fabbri, 1999). Relatively the particular method easy to predict the landslide scenarios with the past available data and the landslide occurrence but the future predictions made some sort of a dilemma because of the factors which occurred to the past landslide occurrence may not be impacted on the future landslide occurrence or maybe there can be new impacts to the future landslide occurrence which is not considered at the past scenario and may be there can be hidden factors which influence higher degree of level to occurrence of the landslide. Therefor the predictions which made on the particular method made question for predicting future scenarios. But this model shows greater impact to the landslide occurrence and their predictions and most of the time shows acceptable level of accuracy and data has been validated with the future occurrence or past landslide predictions.

The liner and non-liner regression analytical methods (Vujica, 1967), statistical approach considered one of the famous method in the landslide prediction process. But this method made some sort of contradiction when evaluating the landslide forecasting in the future because of the situational change,

the spatial differences of the ground and climatic condition change rapidly and sometime it's not shows linearity. Hence the prediction can be vary with the ground morphology and the accuracy might be decline.

Relative risk approach (Kamrul, Habibah, Lea, Afi, & Abdulbasah) and Decision tree algorithm (Karunanayake & Wijayanayake, 2016) models. Both models are used to predict landslide forecasting but both models shows negative and positive impact to the forecasting landslide impact. Relative risk is comparative method to measure the significant of the factors which are impacted to the landslide but comparison between the factors made some sort of confusion and may be some factors are be vary with the ground situation and the considering environment scenario. Decision made tree is route cause analytical method that compromising the root causes to the landslide occur ace and the impact which made to the route will be generate the different level of the landslide probabilities. Considering all above mention methodologies which are used in early scholars to predict the landslide occurrence shows positive and negative c`onstrains and it can be seen combine approaches also used to mitigate the negative contains of each models and mage the accurate predictions.

However, ANN model shows significant accuracy and the predictions which made on shows high accuracy compared to the actual ground scenarios and most of the time model is flexible to use in environmental based modelling with high significance level (Subhashini & Premaratne, 2013).

For the occurrence of the landslide past studies have identified several factors that are caused to the landslide occurrence as Elevation, slope gradient, slope aspect, curvature, landcover, vegetation, distance from road, distance from streams, distance from fault line, geology, soil texture and precipitation with different classes (Subhashini & Premaratne, 2013).

Remote sensing methodologies and technics are doing significant impact on environmental disaster evaluation and mitigation process in multiple sectors (Lee, Choi & Min, 2004). Normalized Difference Vegetation Index and Normalized Difference Soil Index and Normalized Difference Built-up Index calculations are powerful remote sensing technics to identify vegetation condition and its change, soil condition and its change and the build-up areas through the raster calculation methods (Li & Chen, 2018). For the analytical purposes this research only have considered the NDVI calculation out of the other mentioned (NDSI, NDBI) calculations. Hence, this particular research supposed to identify the significance of above mentioned calculations on Landslide forecasting modelling with collaboration with other identified factors such as Slope, Aspect, Distance from the Road Network, Distance from the Stream Network, Profile Curvature, Planeform Curvature (Subhashini & Premaratne, 2013).

$$NDVI = \frac{NIR - RED}{NIR + RED} \quad (1)$$

In NDVI calculation (Afirah, et al., 2018) NIR represent the near infrared band and Red Represent the visible color band and NIR will reflect the vegetation and RED color will absorb because of the photosynthesis process of the plant. By analyzing images recorded from visible red and near-infrared (NIR) wavelengths, it can determine the coverage of vegetation on the surface of the Earth (Afirah, Sharifah, & Asmala). In the NDBI calculation SWIR represent the short wave infrared which will reflect from the buildup areas because of the material type and surface of the structures reflect the short wave infrared band. NDBI enables built-up areas to be mapped at a higher degree of accuracy and objectivity. The assumption underlying the NDBI method is the spectral reflectance of urban areas in SWIR exceeding that in NIR (Zha, Gai, & Ni, 2003).

The Governments and research institutions worldwide have attempted for years to assess landslide hazards and risks and to determine their spatial distribution. In this research it is expected to develop a model to predict landslides using ANNs and GIS.

3. Data Collection and Methodology

The study area is manly focusing on Aranayake GN Division Kegalle District as described in Figure 1, which is already affected to the landslide occurrence in 16th of March 2016 and locations were recorded

by the National Building Research Organization (NBRO) in Sri Lanka. In Particular area temperature of the location is varies from 26°C to 28°C and annual rainfall from 350 to 400 mm.

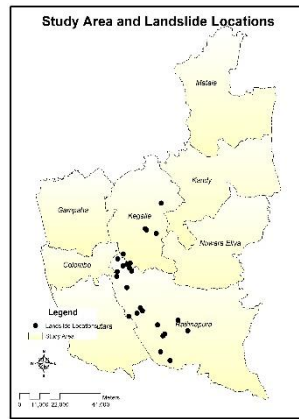

Figure 2, Study Area and Landslide Locations

The particular research considered the both 25 testing points as the training points to acquire the result of the model with all considering factors in the analysis.

As above discussed factors are mainly selected based on the previous research (Subhashini & Premaratne, 2013) (Kamrul, Habibah, Lea, Afi, & Abdulbasah) articles with considering their significance level to the occurrence of the landslide in different scenarios (F, Chung, & Fabbri, 1999). The data which considered are categorized in two different types, road and streams are in vector format and all the other data comes in the raster format. Therefore its need to categorized into one particular type and here used methodology was convert all the data to the raster format and then conduct the reclassification tool categorized them in to different significance level in ArcGIS 10.6. The data for the considering factors are mainly collected from the satellite imagery as raster and the data were acquired from USGS Landsat 8 and 7 data that were used in this study. The data were selected based on the high quality of data acquired by the Landsat satellite and the satellite image corrections were done by the Qgis 2.18 – Atmospheric correction tool. The data were acquired on 27th of November 2001 (Landsat 7) and the 31th of March 2016 (Landsat 8) also purposing of the comparison Vegetation changes and 16th May is one of the immediate landslide occurrence Day of the particular location.

Factor		Factor	
Aspect	Value Level	Profile Curvature	Value Level
Flat	1	(-3.511242) - (-1.242257)	1
North	2	(-1.242257) - (-0.695514)	2
Northeast	3	(-0.695514) - (-0.422142)	3
East	4	(-0.422142) - (-0.230782)	4
Southeast	5	(-0.230782) - (-0.094096)	5
South	6	(-0.094096) - 0.015252	6
Southwest	7	0.015252 - 0.124601	7
West	8	0.124601 - 0.315961	8
Northwest	9	0.315961 - 0.698682	9
North	10	0.698682 - 3.487073	10

Table 1, Aspect and Soil Profile Classification Values

Landslide-causative factors such as slope, aspect, distance from the road network, distance from the stream network, profile curvature, Planeform curvature and vegetation change were considered for the ANN calculations. For accruing the topographic data, digital elevation model (DEM) were constructed with a resolution of 30-meter and the data were acquired from the Earth Observation Research Center /JAXA (Figure 2). From DEM, it is calculated the slope, aspect, profile curvature, Planeform curvature

and the stream network by using Spatial Analysis Toolkit in ArcGIS 10.6. As Table 1 shows the data were classified into the different class values by using reclassify tool considering their significance level according to their classification values (Lee, Choi, & Min, 2004). As shown in the Table 1: the aspect is one of the main factor that impacted to landslide occurrence have been identify in previous studies and profile curvature refers the direction of the maximum slope. Positive values refers the convex, the negative value refers the concave and the zero refers the linearity of the curvature. (Kamrul, et al., n.d.).

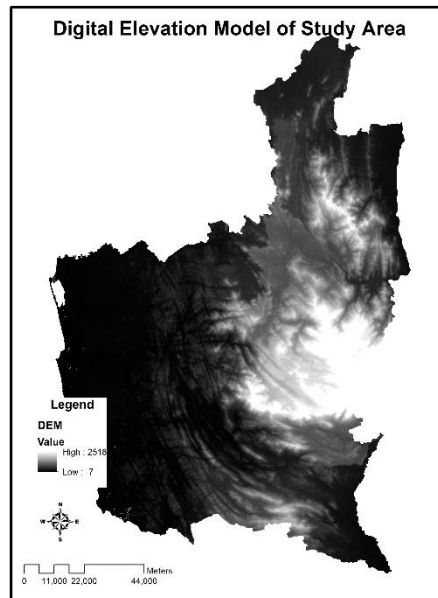

Figure 3, Digital Elevation Model.

According to the previous research (Kamrul, et al., n.d.) there have been identified slope is one of the critical factor to landslide occurrence and when the slope is increase the landslide occurrence probability become higher (F, et al., 1999). The Planeform curvature (commonly called plan curvature) is perpendicular to the direction of the maximum slope. Planeform curvature relates to the convergence and divergence of flow across a surface. A positive value indicates the surface is laterally convex at that cell. A negative plan indicates the surface is laterally concave at that cell. A value of zero indicates the surface is linear. (Bandara, 2005). Table 2: shows the Planeform and the slope according to different classification level and considered the significance of the factors to occurrence the landslide. The Planform curvature (commonly called plan curvature) is perpendicular to the direction of the maximum slope. Planform curvature relates to the convergence and divergence of flow across a surface. A positive value indicates the surface is laterally convex at that cell. A negative plan indicates the surface is laterally concave at that cell. A value of zero indicates the surface is linear (Bandara, 2005).

Factor		Factor	
Planeform Curvature	Value Level	Slope	Value Level
(-2.525286) - (-0.378822)	1	0.025721 - 2	1
(-0.378822) - (-0.175473)	2	2 - 6	2
(-0.175473) - 0	3	6 - 10	3
0	4	10 - 14	4
0 - 0.186037	5	14 - 18	5
0.186037 - 0.389386	6	18 - 21	6
0.389386 - 3.25887	7	21 - 25	7
		25 - 30	8
		30 - 40	9
		40 - 67.525726	10

Table 2, Planeform and Slope Classification Values

For calculating the impact of the road and the stream network for the landslide occurrence the distances are measured based on the Euclidian distance by using the Euclidian distance tool in ArcGIS 10.6 and

divided into the different distance categories based on the impact level as shown in the table 3 and distance are shown in meters. (Lee, Choi, & Min, 2004).

Factor		Factor	
Channel	Value Level	Road	Value Level
0 - 100	1	0 - 100	1
100 - 200	2	100 - 200	2
200 - 300	3	200 - 300	3
300 - 400	4	300 - 400	4
400 - 500	5	400 - 500	5
500 - 1000	6	500 - 800	6
1000 - 1500	7	800 - 1200	7
1500 - 2000	8	1200 - 1700	8
3000 - 9999999	9	1700 - 2500	9
337.5 - 360	10	2500<	10

Table 3, Channel Distance and Road Distance

Calculating the significant factor which the particular research is mainly focusing on the NDVI index is calculating by considering two satellite images which are obtained with 15 years gap (on 27th of November 2001 and the 16th of March 2016) because there cannot be identify rapid land use change of the area with short-term year gap. Also for the better visualization and enhanced the accuracy of the imageries there also have been used pan sharpening method in Qgis to enhance the accuracy of the satellite images (Afirah, et al., 2018). Then after NDVI calculation were run for the both images by using the above mentioned calculation. NDVI classification reference the vegetation condition and its health condition. Based on the previous studies it has been demarcated as follows (Afirah, et al., 2018).

Value of NDVI	Description	Value of NDVI	Description
0.1 or Less	Low NDVI	0.1 or Less	Low Vegetation
0.2 to 0.5	Moderate NDVI	0.2 to 0.5	Moderate Vegetation
0.6<	High NDVI	0.6<	High Vegetation area

Table 4, NDVI value according to their reflections.

As shown in the Table 4 the training data are divided into 3 major classes, Low Vegetation, Moderate Vegetation and High Vegetation areas. Density of the gray color shows the significance of the calculation and it's divided into main thee classes using reclassification tool as above mentioned categories. Afterwards, the color mapping and labeling of the satellite image for three classes were performed. The process of classification based on NDVI threshold is explained and compared to the classified image. As the table 5 shows the vegetation change of 2001 and 2018 was detected from the Landcover Change Detection Tool in Semi-Automatic Classification Plugin in Qgis 2.18.

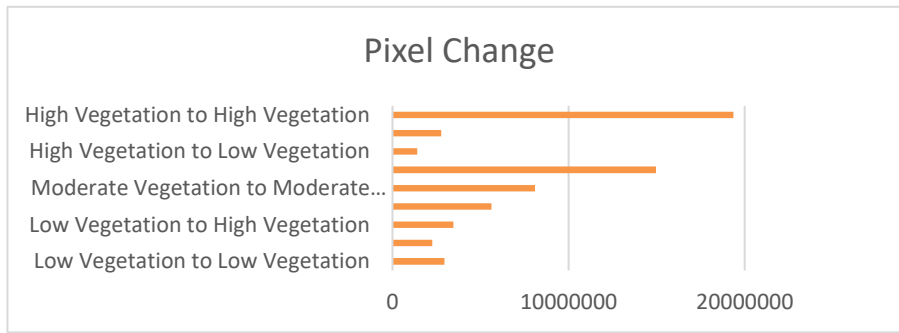

Table 5, Landcover change from 2001 to 2016

Hence, the particular change also be calculated by using image comparison methodology by using the value changes of both layers (2001 – 2016) in each layer attribute tables two considering years.

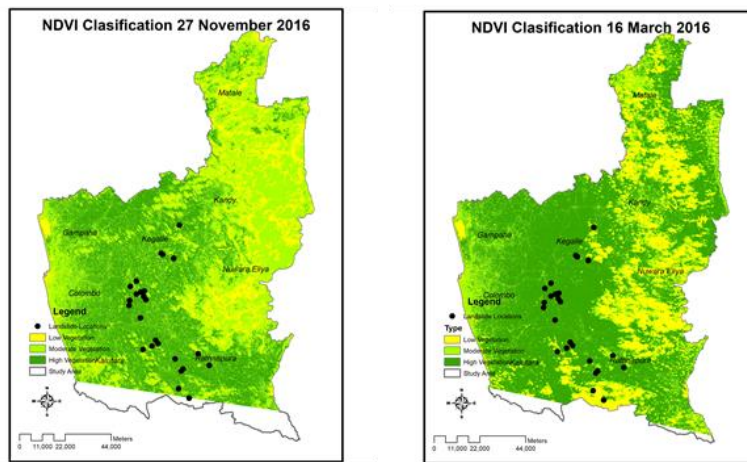

Figure 4, NDVI Calculation in 2001 and 2016

4. Analysis and Results

The model was consisted with identified factors, ANN and classify the data in to two classes as “Landslide Occurrence” and “Landslide Absence” as in Figure 4. Using the identified factors model was trained and the ANN was with seven inputs, one hidden layer with five nodes and two outputs with three layered Feed forward. Training data set was normalized to set the value in between one and zero. The sigmoid transfer function was used in each layer and trained was used as the training function.

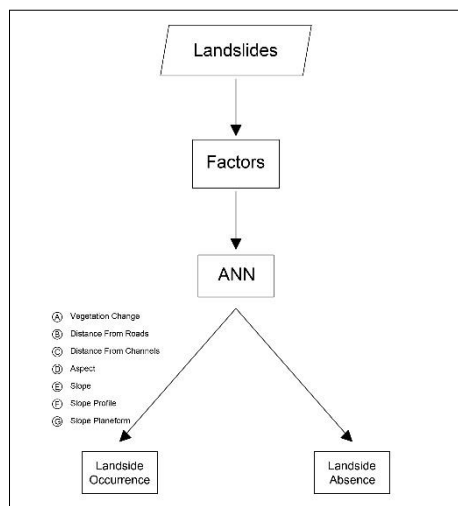

Figure 5, Model Architecture

Model was tested using 25 point for each class. The results has shown in Figure 4: with compared with the baseline model (Subhashini & Premaratne, 2013).

Model	Accuracy
Proposed Model	92%
Baseline Model	83%

Table 5 , Model Accuracy

Based on the selected factors NDVI highly effected on the change. As in Figure 5 for Landslides occurred NDVI is always stable when compared to landslides does not occur.

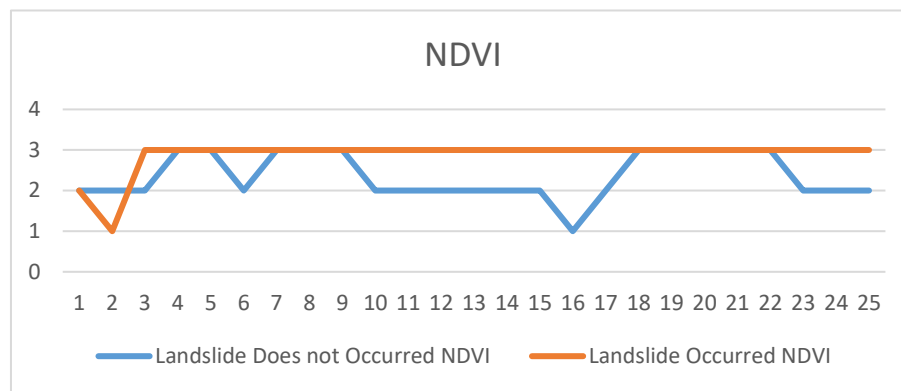

Figure 5, Changes of NDVI

5. Conclusion

This particular research mainly focusing on to the evaluating the significance of the satellite imagery data for the landslide forecast modeling mainly based on the NDVI calculation and its change with the years. Considering the base line model (Subhashini & Premaratne, 2013) which was showed 83% of accuracy level and the presented Model shows the 92% of accuracy level with the considering seven factors specially referencing to the satellite imagery calculated data. Therefore it can be considered Remote sensing technics are doing very essential and significant impact to the landslide forecasting modeling and the NDVI calculation can be considered as a significant factor for the future landslide forecasting practices and simulations.

As limitations of the model there can be identify the low accuracy of the freely available satellite imagery data and availability of recordings regarding the disaster vulnerability and occurrence. It also identify lack of up-to-date factor details such and soil types, road construction data and land use data etc., in developing and underdeveloped countries. Further it can be suggest deep learning network (deep neural network) for the future modifications of the proposed model to enhanced it accuracy and simulation capabilities.

Hence, this particular research findings would be essential for the future landslide predictions and mitigation process for researchers and scientists. Also above mentioned methodology would be useful for the developing and under develop countries for their environmental and urban planning process for the sustainable development.

6. References

- Afirah, T., Sharifah, S. S. A. & Asmala, A., 2018. Classification of landsat 8 satellite data using NDVI thresholds. *Journal of Telecommunication, Electronic and Computer Engineering*.
- Bandara, R., 2005. Landslides in Sri Lanka. *Vidurava*, Volume 22.
- Chaoying, Z. & Zhong, L., 2018. Remote sensing of landslides. *Remote Sensing* .
- F, C.-J., Chung & Fabbri, A., 1999. Probabilistic prediction models for landslide hazard mapping. *Photogrammetric Engineering and Remote Sensing*, p. 1389–1399..

- Kamrul, H., Habibah, L., Lea, T. T., afi, A., & Abdulbasah, K: n.d., Risk Factors for Landslide in Penang, Malaysia.
- Karunanayake, K. B. A. A. M. & Wijayanayake, W. M. J. I., 2016. Predicting landslides in hill country of Sri Lanka using data mining techniques. *International Research Symposium on Pure and Applied Sciences*.
- Subhashini, L.D.C.S. and Premaratne, H.L., 2013. Landslide prediction using artificial neural networks.
- Lee, S., Choi, J. & Min, K., 2004. Probabilistic landslide hazard mapping using GIS and remote sensing data at Boun, Korea. *International Journal of Remote Sensing*, pp. 20037 - 2057.
- Li, K. & Chen, Y., 2018. A Genetic Algorithm-based urban cluster automatic threshold method by combining VIIRS DNB, NDVI, and NDBI to monitor urbanization. *Remote Sensing* .
- Rasul, A., Balzter, H., Ibrahim, G. R. F. & Hameed, H. M., 2008. Applying Built-Up and Bare-Soil Indices from Landsat 8 to Cities in Dry Climates. *Land*.
- Vujica, Y., 1967. An objective approach to definitions and investigations of continental hydrologic droughts. *Hydrology Papers* .
- Weerasinghe, K. M. & Malalasekara, A., 2008. *Learning to live with LANDSLIDES Natural Hazards and Disasters*. s.l.:Department of Institutional Development National Institute of Education.
- ZHA, Y., GAO, J., & NI, S: 2003, International Journal of Remote Sensing, *International Journal of Remote Sensing*.

Samarawickrama, Sumanthri, et al (eds), 2018, "Sustainability for people - envisaging multi disciplinary solution": *Proceedings of the 11th International Conference of Faculty of Architecture Research Unit (FARU), University of Moratuwa, Sri Lanka, December 08, 2018 Galle* pp. 34-41. ©

EFFECTS OF OPEN PLAN WORKSPACES ON JOB SATISFACTION: A STUDY ON SOFTWARE DEVELOPMENT PROFESSIONALS IN COLOMBO

NARANPANAWA. Y.I.¹ & HETTIARACHCHI. A.A.²

^{1,2}University of Moratuwa, Moratuwa, Sri Lanka

¹yash.naranpanawa@gmail.com, ²anishka_h@yahoo.com

Abstract

People in the modern world spend most of their time in workspaces. Yet these workspaces are rarely designed to promote humane aspects. Open plan offices are getting popular despite their effect on people. Recently there is a boost in the local information technology field where many young people work. Therefore identifying effects of open plan workspaces on workers' job satisfaction has become vital. Vision is the prominent way of experiencing a space and spatial layout decides the occupant's visibility in a space or through spaces, creating sense of privacy and interaction. Even though several organizational and environmental factors affect job satisfaction, this paper focuses only on visibility and privacy levels in open plan offices. Visibility graph analysis was recognized as a quantitative analysis tool to measure spatial configuration and a self-reported questionnaire survey was launched to collect qualitative measures on user experience. The analysis proves that different open plan configurations have different visibility patterns and create different levels of privacy. Higher satisfaction levels are reported from software company workers in open plan offices and increased privacy levels are identified in offices having individual workstations with different levels of visibility, which promote flexibility and adaptability within the workspace.

Keywords: *Workspace design, Open plan offices, Visibility Graph Analysis, Job satisfaction*

1. Introduction

When people mention where they 'live', they often talk about their houses or neighbourhood. But people spend their day in workplaces as much as they spend it in their houses. This emphasises the importance of designing sustainable workspaces for people to live in. As humans we have a symbiotic relationship with the environment; the environment influences our behaviour and we in turn influence the environment (Emberson, 2016). Nevertheless most of the current corporate offices use open plans and transparent walls to encourage interpersonal coordination and communication, symbolize organizational transparency, receive daylight and provide views inside and outside ignoring the behavioural and psychological effect of the spatial configuration on occupants (Augustin, 2016)

Vision is the most prominent way of experiencing a space and spatial layout acts as the basic feature which decides the occupant's visibility level in a space or through spaces. Visibility also suggests sense of privacy and level of interaction in a space which affects the perception of space and eventually the job satisfaction levels of the workers. Previous studies have suggested that working environments where visual and acoustic barriers are low, can be distracting (Veitch, 2012) while increasing awareness of colleagues' activities and shared, amenity-rich common spaces encourage interactions (Allen & Henn, 2007). Most of these studies use empirical evidence and show contrasting results.

The present paper explore the application of space syntax tools to analyse spatial qualities quantitatively and investigate the effects of open plan layout on the job satisfaction of IT professionals. The study is limited to three software companies located in Trace expert city, Colombo in order to control other environmental factors that affect job satisfaction. The organizational and individual differences are minimised by selecting similar companies which are engaged in transactional knowledge work involving sedentary behaviour and young workers with similar educational backgrounds.

Spatial layout of each case study is analysed using space syntax theory based depthmapX software developed by Tasos Varoudis and the knee level of an average person is taken as observation height to include furniture as barriers for permeability. The visibility level of overall layout and individual

workstations are considered for the analysis. The individual job satisfaction levels are measured through a self-reported questionnaire survey and compared with visibility values.

2. Literature Review- Work, workspace and the worker

As Churchill (1924) mentioned we make our buildings and afterwards our buildings make us. This reciprocal nature often makes it difficult to explore the factors that lead to certain design choices, human behaviour and experience. When it comes to workspace design, these design choices can be categorised as organizational, social and environmental. Workspace design starts as a response to the demands of an organization; the employer wishes to get maximum output from his employee. But it is difficult to achieve without considering the environmental comfort of the workers. Nonetheless it is during the occupancy stage that we get to observe the compatibility of the workspace with its users.

2.1. ORGANIZATIONAL DESIGN OF A WORKSPACE

Francis Duffy (1985) defines a building as the framework that permits technology, organization and communications to coexist and he further states that architects should know data about technical variables, socio technical variables and technical organizational variables when designing a workspace. He introduced organization typologies depending on two elements: the nature of work (routine/non-routine) and the nature of change (slow/rapid). He also predicted that the tendency of workspace is towards more rapid change and less routine (Saurin, 2012). Therefore emphasising the need for more flexible and adaptive workspace designs.

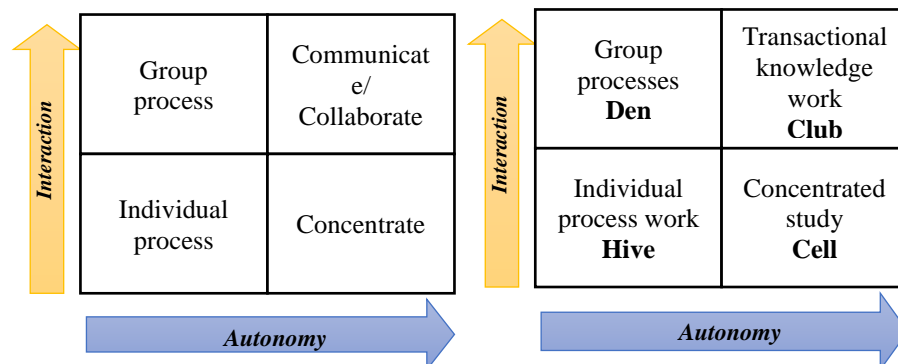

Figure 1: Different kinds of work styles

Figure 2: Types of spaces corresponding to the styles (Deb,

Along with the changing nature of the workspaces, office layouts have evolved from elemental solitary dens to open plan offices and office clubs. When considering both advantages and disadvantages of an open plan layout that have been studied over the past decade, the role of visibility in determining the level of communication and privacy can be identified as important.

2.2. SPATIO-VISUAL PATTERNS OF WORKSPACE LAYOUT

The idea of patterns or generic relationships in buildings is vastly discussed by Christopher Alexander (1977). These work are based on his “human, sensitive and scientific” approach to architecture which is a design philosophy that is timely and worthy. Francis Duffy in his article, Architects and social sciences (1968) remarks the relevance of patterns to the job/ worker/ building model.

Hence spatio-visual patterns are the building blocks that are created in relation to one’s visual access in a space. Visual access can be defined as the degree to which different places and features in an environment can be seen and it is a significant physical characteristic of an environment. Moreover in 1981, Weisman has stated that changes of appearance of an environment, the allowed visual access and the complexity of the spatial layout as the psychology relevant physical characteristics of an environment. (Montello, 2007)

Spatio-visual patterns encourage certain behaviours in a space. Face-to-face communication and interaction, privacy, territoriality, control and supervision have been suggested as the psycho social

constructs in a workplace by a review done by Mahbub Rashid and Craig Zimring after referring a number of empirical literature.

2.3. ENVIRONMENTAL PSYCHOLOGY OF WORKSPACE

Working can provide some of the best and some of the worst experiences in life. Many factors determine a person’s productivity, stress, and satisfaction at work and among them psychologists have identified that the physical environment has an important influence on employee productivity and satisfaction. (Gifford, et al., 2011)

Vischer (2008) introduces a model with three types of environmental comfort; namely physical comfort, functional comfort and psychological comfort, to organize the users’ experience of workspace. Satisfaction and functional comfort are mentioned as the basic measures to understand building performances. But she clearly mentions that for achieving more valid measurements on worker satisfaction, questions should be asked to check how the specific environment condition has affected one’s ability to work.

Many studies have tested user satisfaction levels under specific environmental conditions and recognized the effects of lighting, mechanical ventilation rates, availability of natural light, acoustic environment and furniture on people’s preferences. (Vischer, 2008) These studies suggest that environmental satisfaction is discreetly a measure not only of workspace effectiveness but also on job satisfaction.

The interrelationship between work, worker and workspace is understood through reviewing literature and the theoretical framework is developed as shown in the figure 4.

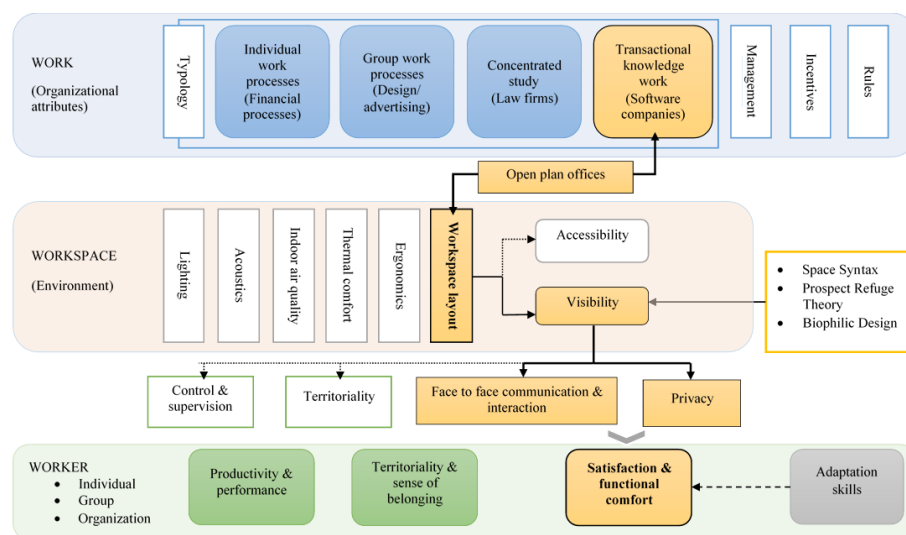

Figure 4: Summary of literature review

3. Research Question

Workspaces has become an integral part in people’s lives and keep changing in nature. However a decline in number of recent workspace research is observed in relation to the level of change, especially in local context. Additionally differences in open plan layouts were rarely discussed despite their popularity. Therefore it is worthwhile to examine whether spatio- visual patterns of different open plan offices have an effect on the job satisfaction level of its users.

Following set of hypotheses was formulated to clarify the research question and direct research methods

Hypothesis 1- Different open plan configurations have different visibility patterns.

Hypothesis 2- Open plan workspaces with better visibility may increase face to face interaction among co-workers.

Hypothesis 3- Increased visibility level may disturb one’s sense of privacy at their individual workstation.

Hypothesis 4- Open plan workspaces with better visibility and privacy will improve task performance and group relations ultimately increasing job satisfaction

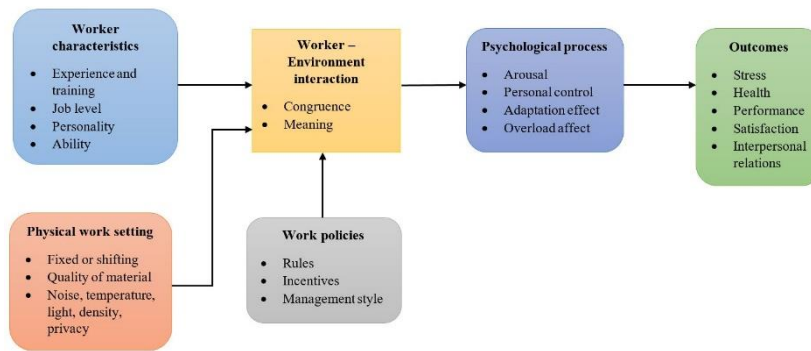

Figure 3 Influences of the physical work setting on workers (Gifford, 2007a)

4. Methodology

Work force engaged in information technology sector jobs keeps growing day by day and lesser number of research is done on them. Therefore three software companies located in the same building in Maradana trace expert city, are selected as cases studies. The organizational, environmental and social aspects are similar among the selected cases despite the different spatial configurations created by different workstation arrangements.

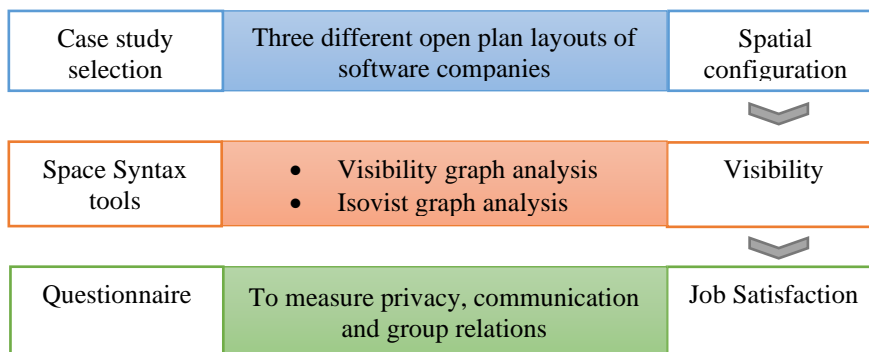

Figure 5: Research Methodology

The selected case studies; three identical bays number 1, 8 and 11 from company A, B and C respectively are measured and drawn to identify different spatial configurations as shown in figure 6.

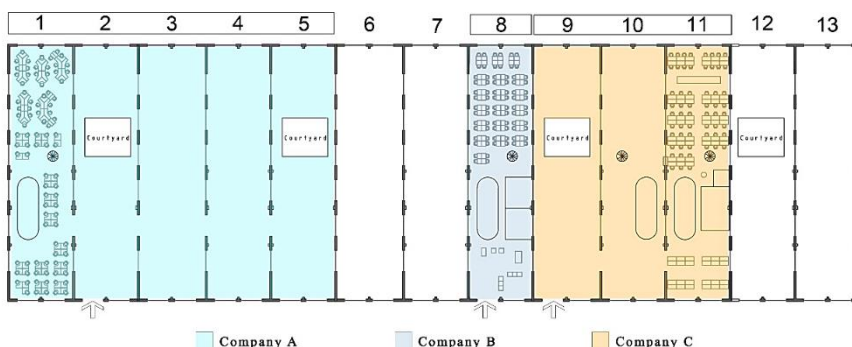

Figure 6: Main building layout

Connectivity and visual integration measures are taken for each case, considering the knee level in order to include layers for both eye-height obstructions (such as walls, table partitions) and other objects that might block permeability such as tables and chairs. After importing layout plan to depthmapX software,

the grid is set at 10 x 10 and chair positions are assumed as visibility points at the midpoint along the width and attached to each desk.

Job satisfaction was determined as the dependent variable of the research and the questionnaire was designed to measure its variance. To achieve valid measurements on worker satisfaction, questions are prepared to check how the visibility levels has affected one's ability to work. It is assumed that positive privacy, interaction and group relations improve the ability to work and eventually increase job satisfaction.

First five questions checked whether one has enough privacy to successfully engage in daily tasks. Next three questions explored the availability of face to face interaction and useful communication. Then two questions were included to measure related behaviour. Improved group relations are expected to increase satisfaction (Kim & Dear, 2013). Hence next six questions explore the nature of group relations. All the items in the questionnaire are to be answered on the same 5 point scale, ranging from -2 (strongly disagree) to +2 (strongly agree).

5. Finding and Analysis

Number of workers in company A, B and C are 91, 76 and 58 people respectively. Out of them only 19 people responded the questionnaire from company A and 10 people responded from both B and C. Among respondents 86% are male and 14% are female. According to the job description 29% of the respondents belong to entry level professionals while 42% and 29% are middle level and senior level professionals respectively.

5.1. COMPARISON OF DIFFERENT OPEN PLAN WORKSPACES

Initially the visibility graph analysis maps produced for company A, B and C are compared to explore the accuracy of hypothesis one which is the basic observation behind generating the research question. For investigating the expected differences three VGA connectivity maps and integration maps are compared and results are as follows.

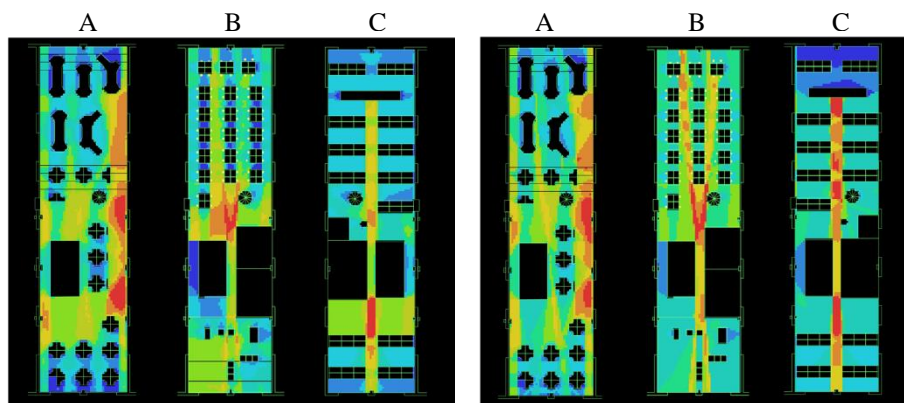

Figure 7: Connectivity maps

Figure 8: Integration maps

- Different colour patterns show the difference between each company
- Movement within each space is encouraged in different manner.
- In company A, the main entrance to the workspace is located at the point with the highest integration. Most of the workstations are easily accessible and visible from the entrance. The shared facilities are also fairly accessible.
- In company B, workstations are away from the main entrance while the maximum connectivity is at the staircase that leads to mezzanine floor. Accessibility to each workstation is approximately similar. Workstation in the boundary has more visual privacy while circulation space has more points which are well-integrated.
- In company C, accessibility is diminishing towards the workstations located in the back. Main circulation paths has low connectivity values compared to other cases. Circulation path has become the most integrated space while most of the workstations have equal amount of visual connectivity.

The data derived from visibility graphs analysis is cross referenced with the data collected through questionnaire survey (Table 1).

Table 6: Comparison of mean values of workspace outcomes with VGA measures

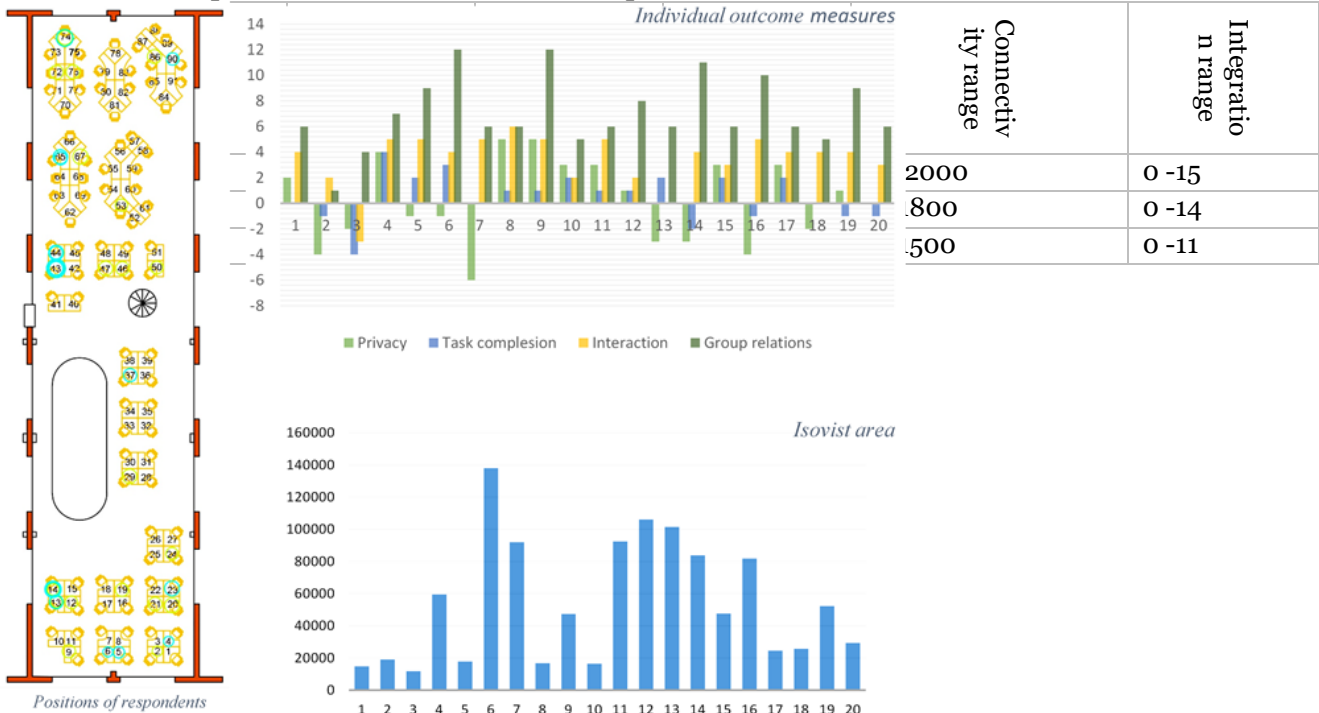

Figure 9: Workstation level isovist analysis of company A

According to the connectivity and integration values obtained from visual graph analysis; company A has the widest range of connectivity and integration. Even though it was predicted that higher visibility will disturb one’s privacy; table 7 shows positive privacy level for A. Therefore having a range of workstations with different levels of visibility may provide several choices for the workers and increase sense of privacy.

Moreover contrasting values were produced regarding interaction outcomes. Company C with lowest integration range had reported the highest interaction rate. This paved the way for another probable conclusion. When the range of integration is low the segregation of co-workers into smaller groups is limited. This statement is supported by the rating of group relations.

5.2. WORKSTATION LEVEL ISOVIST ANALYSIS

Effects of visibility on individual’s functional comfort and satisfaction are studied through comparing the isovist area relevant to the respondent’s workstation location with the given responses. Therefore each respondent became a subject in the analysis. Twenty responses were received from company (A) while ten responses were received from both companies B and C.

First the ratings obtained from each individual is tabulated and sum of the values relevant for privacy, task completion, level of interaction and group relations are calculated separately. Then the isovist area corresponding to each individual is obtained from isovists area map generated from visibility graph analysis and isovist area of each respondent is graphed (Figure 9).

Finally the workstations with highest and lowest isovist area are compared to test the validity of the research hypotheses and results are as follows.

In Company A, 35% workers indicated poor privacy levels and 71% of them were working in points with higher visual integration. 30% people were struggling to complete their task and 67% of them were exposed to other workers. The person who mentioned to have low level of interaction was located in the least visible location out of the selected subjects. Every respondent indicated positive values for group relations.

In Company B, 20% workers reported to experience lack of privacy and they were the people who occupied the highest visibility points in the office. 60% of the respondents were reported difficulties in task completion and 60% of them indicated higher visibility. Interaction levels and group levels were reported positive by all the respondents

In Company C, 60% of the selected occupants indicated lack of privacy and 67% of them had higher isovists areas. 50% of respondents reported to spend more time in their offices to complete tasks and only 50% of them were located in higher visibility locations. 80% of the people with higher interaction levels were seated in more visible locations.

6. Conclusion

This research is executed to find out the effects of local open plan workspaces on worker satisfaction and limited to software development professionals in Colombo. Moreover the research is restricted to visual experience of the workers.

Through referring literature and theories hypotheses are established and outcomes regarding the hypotheses are as follows;

Hypothesis 1: Different open plan configurations have different visibility patterns

Different colour patterns produced by visibility graph analysis proved that different open plan layouts have different visibility patterns and movement patterns. Therefore can promote different behavioural patterns

Hypothesis 2: Open plan workspaces with better visibility may increase face to face interaction among co-workers.

Workspace level visibility analysis conducted using individual responses marginally proved that better visibility leads to better interaction while suggesting that visibility only will not promote interaction. Comparison between cases proposed that when higher range of integration can segregate co-workers into smaller groups and diminish overall interrelationships of the workspace.

Hypothesis 3: Increased visibility level may disturb one's sense of privacy at their individual workstation.

Comparison between cases suggested that having a range of workstations with different levels of visibility may provide several choices for the workers and increase sense of privacy while individual level analysis supported the hypothesis.

Hypothesis 4: Open plan workspaces with better visibility and privacy will improve task performance and group relations ultimately increasing job satisfaction

Selected case studies provided higher levels of visibility and considerable amount of workspaces with privacy. Therefore all the cases displayed positive satisfaction levels. Therefore it can be concluded that open plan workspaces are suitable for software companies in Colombo.

Finally it can be concluded that open plan workspaces with more flexibility and adaptability in terms of visibility improves privacy levels and increases the job satisfaction of software development professionals. Moreover the applicability of space syntax tools in workspace design to create visibility patterns is verified.

References

- Allen, T. J. & Henn, G. W., 2007. *The organization and architecture of innovation: Managing the flow of technology*. Burlington: Butterworth–Heinemann publications.
- Augustin, S., 2016. *At Work, In View: The Cognitive Science of Working in Spaces with Transparent Boundaries*. San Diego, Academy of Neuroscience for Architecture, pp. 16,17.
- Emberson, J. S., 2016. *THE ARCHITECTURE OF CONFINEMENT: POSITIVELY INFLUENCING REHABILITATION AND REINTEGRATION*, Ann Arbor: ProQuest LLC.
- Gifford, R., Steg, L. & Reser, J. P., 2011. Environmental Psychology. In: *IAAP Handbook of Applied Psychology*. s.l.:Blackwell Publishing Ltd, pp. 440-470.
- Montello, D. R., 2007. *The contribution of space syntax to a comprehensive theory of Environmental psychology*. Istanbul, s.n., pp. 4-12.
- Rashid, M. & Zimring, C., 2003. *Organizational constructs and the structure of space: A comparative study of office layouts*. London, s.n., pp. 43.1-43.20.
- Saurin, R., 2012. *WORKPLACE FUTURES: A case study of an adaptive scenarios approach to establish strategies for tomorrow's workplace*, Dublin: Dublin Institute of Technology.
- Vischer, J. C., 2008. Towards an Environmental Psychology of Workspace: How People are affected by Environments for Work. *Architectural Science Review*, pp. 97-109.

Samarawickrama, Sumanthri, et al (eds), 2018, "Sustainability for people - envisaging multi disciplinary solution": *Proceedings of the 11th International Conference of Faculty of Architecture Research Unit (FARU), University of Moratuwa, Sri Lanka, December 08, 2018* Galle pp. 42-49. ©

USING VISIBILITY FOR ENHANCING SPATIAL INTERACTION WITHIN AN ORGANICALLY DEVELOPED NEIGHBORHOOD OF *DHOLAIKHAL*, OLD DHAKA.

CATHERINE DAISY GOMES¹, SIMITA ROY² & BRISHTI MAJUMDAR³

¹ Professor Department of Architecture, Bangladesh University of Engineering and Technology, Dhaka,

² Lecturer and M. Arch student, Department of Architecture, Bangladesh University of Engineering and Technology, Dhaka

³ Lecturer and M. Arch student, Department of Architecture, Bangladesh University of Engineering and Technology, Dhaka

¹catherin@arch.buet.ac.bd, ²simita.arch@gmail.com, ³brishti1001027@gmail.com

Abstract

Dhaka, the capital of Bangladesh, has grown from a small trading town to a metropolitan city by developing an organic pattern spontaneously. Simultaneously rigid planning developed in line with the inhabitant's aspirations with time. A pattern of house form prevailed in the urban houses of Dhaka, which was the product of the social and cultural norms of the people. In congested neighbourhoods of Old Dhaka, people have developed the interaction points and sense of place spontaneously. In case of the neighbourhoods known as '*mohallas*', the streets and the pocket space between the buildings act as social spaces of the resident.

With the help of Visibility graph using Depth map, and questionnaire survey, this paper tries to illustrate the relationship between socio-cultural aspects of public/private realms using the notion of the social sphere as an investigative tool of the concept of social space in '*Dholaikhal*', a local community (*Mahalla*), of old Dhaka. The focus is on how the visual integrity of shared community outdoor space in the congested neighbourhoods of Old Dhaka encourage the residents' interaction and activity. Focusing on urban green spaces, this paper also provides empirical evidence for use patterns that make spatial interaction between different social groups possible. The outcome of this research is expected to contribute by understanding the visibility relations of the shared community spaces and raising awareness among the architects, policymakers and builders regarding the need of socially integrated shared spaces to ensure community interaction and enhancing spatial interaction.

Keywords: *Visibility relation, social integration, neighbourhood (mahalla) of old Dhaka*

1. Introduction

Dhaka, being the capital city of Bangladesh, has undergone through a continual transformation during the last few decades. The Old City of Dhaka served as the Mughal capital of Bengal in the 17th century. After a period of decline under British rule, the modern city began to develop in the late-19th century. During the Bangladesh Liberation War in 1971, Dhaka emerged as the capital of an independent Bangladesh. Dhaka in pre-Mughal period served as a prominent market centre (from 1204-1576). Under the Mughal rule, the Old City of Dhaka grew the banks of the Buriganga River (Gomes and Nilufar, 2012).

Nilufar (2004) has defined Dhaka having two distinct parts as old and new. The historic part, the old Dhaka, has an organic morphology and it retains many traditional features. The residential Neighbourhood of old Dhaka has been locally known as '*mohallas*'. The neighbourhood is primarily a social phenomenon arising from cohabitation in a physical area. Nilufar (2004) gives evidence of 'local community' only defined by the territorial boundary, which reflects inhabitants' particular need for identity and sense of a place in a city. It extends that such spatial organization can play a positive role in social organization.

1.1 'Neighbourhood'- a Socio-Spatial Concept

Mumford, (1968) defined the word 'Neighbourhood' in terms of the people united primarily by the proximity of their dwellings in space (Mumford, 1968). Primarily 'Neighbourhood' is a social phenomenon rooted in rural society and basically a small, recognisable sub-unit of the city (Glass, 1948). All these Neighbourhood ideas have two main components: Physical and Social. Rapoport (1977) claims that the nature of the meaning and relationships among the elements as well as the associated human behaviour differ under different socio-spatial situations. It is, therefore, believed that in urban areas the built environment also plays an important role in the formation of social behaviour pattern in the local Neighbourhood areas.

Sometimes physical boundaries like streets, railroads, parks, canals demarcate the Neighbourhood area. Western cities are more likely to orient themselves towards the public spaces and have physical barriers like railroads, park and roads However Schoenaues (1981) finds territorial boundaries are mostly semi-public realms with local community facilities in the oriental society. Historically in old Dhaka 'Neighbourhood organisations had a territorial base; a *Mohalla* or Neighbourhood was sharply bounded and studies on Old Dhaka by researchers claim that morphologically the access street was the centre of the *Mohallas*. (Khan, 1982). A number of localities have a diffused edge being surrounded by adjacent localities without any distinctive physical boundary. However, where geographical barriers, like a canal or river, appear in close proximity people tend to refer those in some cases.

1.2 Spatial organisation of residential unit in Old Dhaka

In the context of Dhaka, the urban house form generated from the rural pattern and the morphology of the urban house form is the result of various urban forces generated at different phases of growth of the city. In the indigenous urban houses of Dhaka, the inner court served private family purposes. This earlier urban morphology followed a public-private domain.

Gomes (2016) found that the denotation of 'public' and 'private' implied that some form of spatial pattern accompanied the separation of women and men into different activities (Gomes, 2016). Some spaces are used by the male members extensively and some by female members extensively. Thus the Courtyard was the central space of all activities and it acted as the threshold transient semi-public space between the habitable rooms (the private territory) and the living room (the public territory).

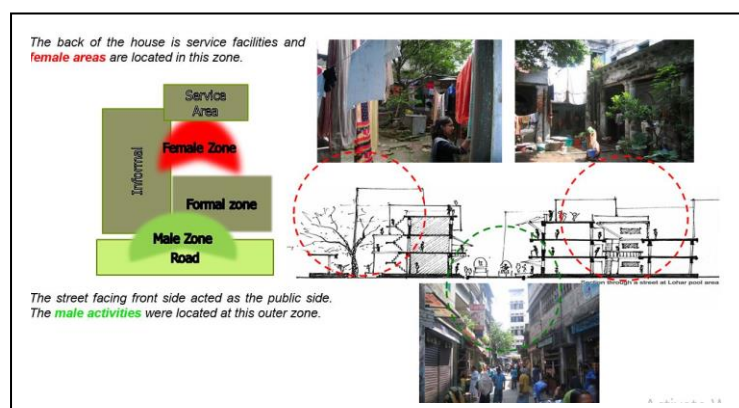

Figure 1.1: Domains in the spatial organisation of old Dhaka (source: Gomes, C.D., 2016)

Traditional Bengali house was organized with the concept of 'back and front'. The street and the street facing front side acted as the public side, receiving guests and restricting them to a limited area. The male activities were located in this outer zone. The back of the house is associated with service facilities and female areas are located in this zone. The female household members were mostly kept confined within the boundaries of the house where the courtyard was their breathing space and their universe.

1.3 Visibility affecting Social Interaction in Neighbourhood

Visibility is one of the essential attributes that make a Neighbourhood social space interactive. Among other physical factors like the layout and the location of public spaces, Raman (2010) found that social interactions and social activities are related to visibility from and to the spaces and visual links between neighbourhoods. Vanessa et al (2012), in their study of accessibility in a park in Brazil, found the visual access or visibility to be an important aspect which makes people feel free to enter a space, whether it is safe to enter in it or not. They concluded that the more visible space is, the more likely it is to be perceived as a public space.

Studies in environmental psychology suggest four basic spatial needs those are culturally determined and that are universal to human beings as The need for Privacy and personal space; the need for easy access to social interactions and the right to safe and defensible space. According to Oscar Newman's Defensible Space (1972), human beings are territorial-they define space and mark them for specific uses, create visible or invisible boundaries and defend their territory from unwanted intrusion. 'Natural surveillance' is the capacitance of physical design to provide surveillance opportunities for occupiers. The physical environment of a place along with its accessibility and the extent of the local social ties there, all have an effect on the nature and type of routine activities that take place. These routine activities and the image they generate affect occupants' attitudes towards their territory and their territorial behaviour. Occupants' ability to create defensible space by acting as capable guardians, therefore, directly determined by these routine activities.

Reynald, D. M., & Elffers, H. (2009) showed that based on ethnographic study and statistical analysis an interdisciplinary team of architects and social scientists formulated a model based on the concept of defensible space. This concept suggested that by grouping dwelling units in a particular way, by delimiting paths of movement, by defining areas of activity and their relation to other areas, and by providing for visual surveillance, one could create a clear understanding of the function of a space and its intended users with respect to inhabitants and strangers.

Williams (2005) identified good visibility, clustering, the inclusion of defensible space and car parking on the periphery of communities, etc. as design principles being crucial to high levels of social interaction in neighbourhoods. Williams found the Principles of Designing Neighbourhoods for Social Interaction Social contacts to be enhanced in a community when residents have opportunities for contact, live in close proximity to others and have appropriate space for interaction. Residents' ability to see and hear others using public spaces outside their home greatly influences their sense of community and enables them to observe others with whom they would like to interact. Thus, enabling surveillance through community layout and building design is important in terms of encouraging social interaction. Shared pathways to activity sites (private units, parking spaces and local facilities) in a community also increase the potential for social interaction. Communal spaces provide excellent opportunities for social interaction. In terms of their position in the layout of the community, facilities need to be central and accessible. As key activity sites, communal facilities should be placed on shared pathways within residential areas to maximize social interactions. Visibility of communal facilities is also important to increase opportunities for surveillance, thus increasing use and opportunities for social interaction.

Like surveillance, Privacy and Visual Dominance guided the domestic spatial organization with control of visibility of inner spaces from public areas and restriction of access of the visitors in the context of Dhaka. (Gomes C D, 2015). The doorstep forms a boundary between the private realm of the family, away from the scrutiny of others where they can exercise control over outsider's involvement in domestic affairs, and the public world of wider society. Thus the streets and alleys beside their house

become their interactive space in the Neighbourhood. Female members and the children use the lanes in the Neighbourhood and the male members the main roads for different social interactive activities.

2.0 Space Syntax: A Theory and Method of Analysis

Data on social interactions, and social activities along with perceptions of the built and social environment of the neighbourhoods were collected through observations, questionnaire surveys and secondary data sources. Neighbourhood design and layout were analysed using visibility graph analysis methods. The concept of Social Interaction, which is dependent on the visual relationship, is addressed with the visibility graph analysis in this research. Visibility Graph¹ analyses the extent to which any point in a spatial system is visible from any other. In this study Depth map programme 10, developed at University College London by Alasdair Turner (2003), is used for analysing the visibility pattern of the neighbourhoods to interpret Social Interaction level in a quantitative manner. (Turner, et. al., 2001)

Social Interaction which is difficult to be measured can be interpreted by the accessibility of both physical and visual and it is associated with the visibility aspect of the outdoor common shared spaces. Visual integration² of spaces gives certain numerical values which express that space to be visually connected with the adjacent spaces. The more space is visible from the outsiders or visitor's area the less privacy is ensured there as it is more connected visually and thus more interactive. Thus space which has high visual integration will be less private and more socially interactive.

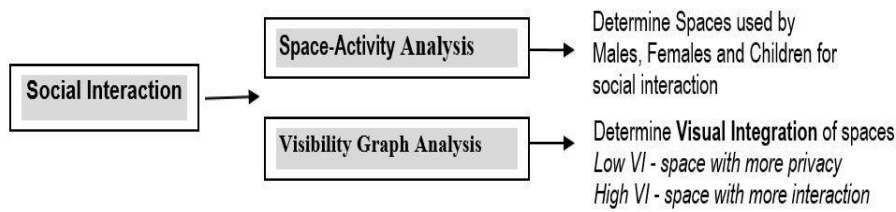

Figure 2.1: Domains in the spatial organisation of old Dhaka

3. Study and Analysis

The study area Dholaikhal is one of the major drainage canals of Dhaka which had a connection to the river Buriganga. Lack of maintenance and disconnection with the river the remaining parts of the canal has become polluted and septic and constituted a serious threat to the health of the citizens living in the vicinity of the canal (Md Shehab U, 2002). The study area reflects a strong socio-cultural identity of its people which is reflected in the spatial organisation of the neighbourhood. The narrow roads and lanes have a human scale and hold different Socio-cultural interactions. The public spaces take on special meaning and values, as an extension of household activities and a place for face-to-face contact in a mahalla.

3.1. Activity Pattern Analysis

The Neighbourhood area around the Dholaikhal canal is analysed considering the open *Khal* (water body). Twenty-two points were identified (shown in Figure 3.1) on the road, open space on the banks of the canal and three neighbourhoods on the right and left the side of the *Khal* (water body).

¹ Visibility refers to Visual information provided to the observers at any given location. The graph gives certain numerical values of each space which expresses the visual connection of that space with the adjacent spaces.

² Visual integration is similar to global integration describes the relative visibility of a point location to all the other points within the space. The measure is essentially a normalized version of the mean depth of the visibility graph (Turner and Penn, 1999; Tuner, 2001; Turner, et. al., 2001).

The study is conducted in two levels:

- 1) Studying the Visibility in global scale and
- 2) Studying the Visibility in a local neighbourhood area.

Different activities of the residents in these areas were observed and analysed in detail with questionnaire survey which is compared with the visual integration values of the spaces those are used as social interaction for different groups in different time. The activities are shown in Table 3.1.

3.2. SYNTACTIC ANALYSIS

In this study Neighbourhood areas in Dholaikhal of old Dhaka is studied syntactically using VGA. Visual integration value of the points considered as socially interactive of the whole area as it is in the present state (Case A) is compared with the second case (Case B) with a few streets added with the open *Khal* (water body) area which is shown in Table 3.2 and Figure 3.3(a).

Table 3.1: The activities in the Dholaikhal Area

Activity in different Points		
1	This nodal point acts as a temporary bazaar. The road alongside the canal meets with the main road at this point.	Road
2	At this point the narrow alleyway as actually a daytime bazaar beside the canal which creates a public space for the people.	
3	This point is the starting point of a <i>mahalla</i> .	
4	This point is a nodal point of four roads.	
5	At this point, a Hindu temple has been found acting as the focal point of social interaction of the community.	
6	There are a local restaurant, a saloon and some grocery shops at this point. Social interaction between male persons, young people and children can be found at this point.	<i>Khal</i> (water body)
7	This road alongside the canal acts as an active social space which is public in nature.	
8	Children play at the buffer space between the canal and the road.	
9	The narrow alleyway starting from point 2 has been blocked by a dwelling unit.	
10	There are few pocket spaces beside the canal but because of the lacking of the proper connection these spaces act as the negative spaces. The community people use these spaces for waste dumping. So the spaces lose the potentiality for being a social space.	
11	The alleyway has been blocked at this point by a dwelling unit. People can reach the canal through this dwelling unit which isn't visible at all.	Neighbourhood -1
12	This narrow alleyway also has been blocked by a dwelling unit. The interaction between female dwellers can be found because of the placement of water source.	
13	This nodal point acts as an active social space for the community. Temporary food stalls can be found at this point and people gather around it.	
14	Because of the restriction of vehicular movement the streets act as a safer place for the children's play.	
15	Another backyard pocket space having the potentiality for being a social space alongside the canal.	
16	At this point, a Hindu temple can be found. During morning and evening, this nodal point acts as an active social space.	Neighbourhood -2
17	The grocery store in the <i>mahalla</i> is another point of social interaction.	
18	This point entered from the secondary road isn't visible but acts as an active social space for 3-4 families living around it. The common space is used for storing water, drying cloths, gossiping and children's play space.	
19	Several pocket spaces between the buildings act as a safer play area for the children. This point is that kind of pocket space.	

20	A pocket space between the buildings acts as a social interaction point.	Neigh-3
21	Children are playing in the pocket space between the buildings.	
22	A small grocery store at the nodal point of two narrow alleyways.	

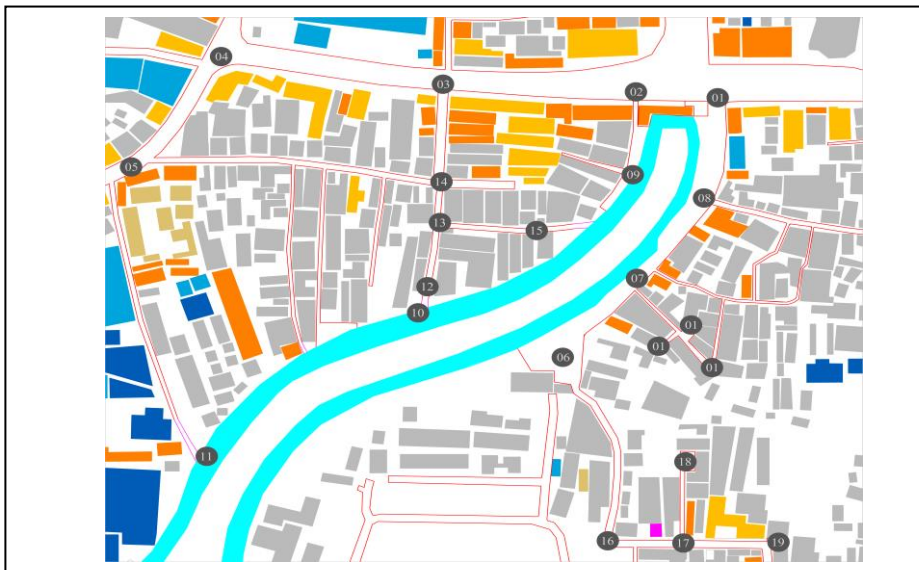

Figure 3.1: Map of Dholaikhal area showing the study areas/points



Figure 3.2: Different Point with Photographs (Source: Produced from the Authors' Field survey 2018)

Table 3.2: Visual Integration value (VI) of different points in two case study areas

	Poin	Case A VI	Case B VI	Location	Point	Case A VI	Case B VI
Road	1	8.64	9.38	Neighbourhood -01	12	4.93	5.76
	2	7.96	8.02		13	5.00	5.83
	3	7.37	7.84		14	5.48	5.96
	4	6.87	7.11		15	2.71	4.23
	5	4.90	4.95		Neighbourhood- 02	16	3.08
Khal	6	5.65	5.7	17		2.46	2.46
	7	6.92	6.94	18		1.74	1.74
	8	6.86	6.90	19	2.46	2.46	
	9	6.09	6.21	Neighbourhood -03	20	3.30	3.30
	10	4.17	4.96		21	4.55	4.56
11	3.34	3.71	22		4.58	4.57	

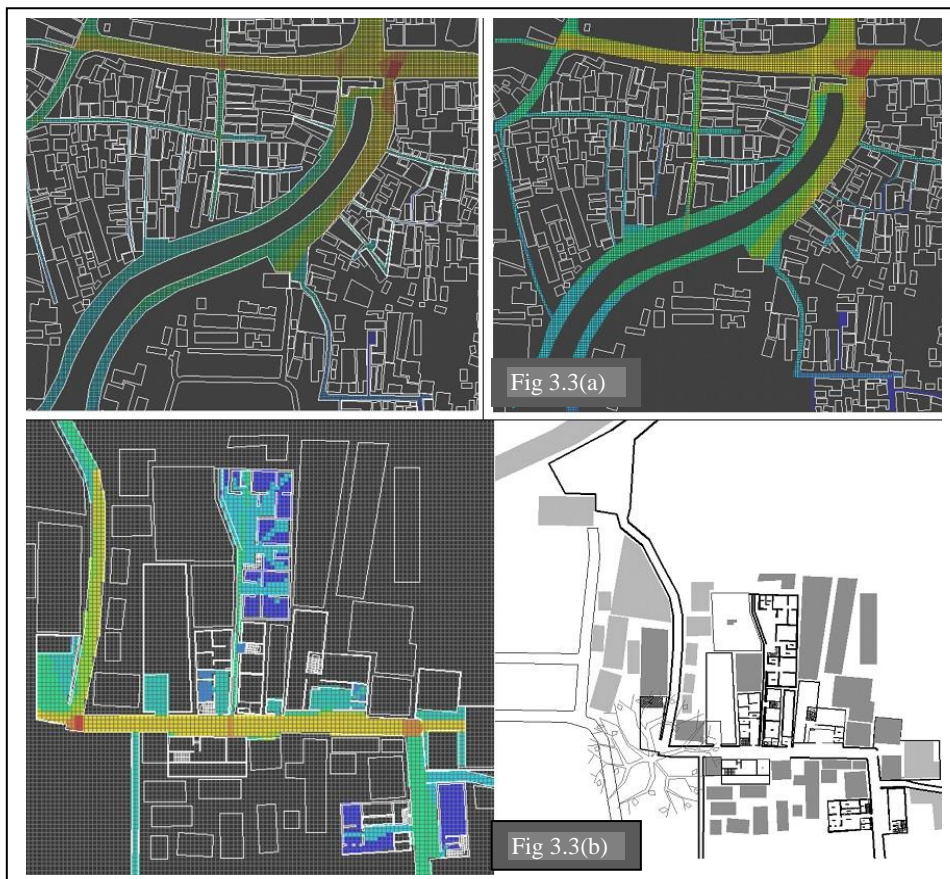

Figure 3.3: a) Visual Integration (VI) of different points in two case study areas.
b) Visual Integration (VI) of Neighbourhood 2.

Study leads to findings that:

- The roads have the highest VI values and are used as public areas (Point 1, 2, 3, and 4) and with lower VI are in neighbourhood areas and are more private in nature (Point 5).
- The space along the waterfront has higher visibility and the VI is comparatively higher in right side bank (point 6, 7, 8) where neighbourhood 2 and 3 are located. These spaces are used mostly for different social activities by the people of this two neighbourhood. The left side bank (point 10, 11) has comparatively lower VI than the other side. When the four disconnected roads in this area are connected with the waterfront area the integration value increases in these points.
- Neighbourhood 1 is located on the left side of the open *Khal* (water body). The roads in this area (points 12, 13, 14, 15) have lower VI value compared to the main roads (Point 1, 2, 3, and 4) and are more private in nature. Different social interactions of the female and children's take place in these lanes of the neighbourhood. VI of these points increases when the four dead-end roads are connected with the open *Khal* area which is clearly visible in the VI values of points 12, 13, 14 and 15 in case B.

4. Conclusion

In congested neighbourhoods of *Dholaikhal* in Old Dhaka, people have developed the interaction points and sense of place spontaneously. Different social activities take place in the pocket space between the buildings and streets act as social spaces of the resident. Visibility of these spaces has an impact on the social activities of these spaces. The more space is visible from the outsiders or visitor's area the less privacy is ensured there as it is more connected visually and thus more interactive. Thus space which has high visual integration will be less private and more socially interactive.

The main roads are used as public areas and have the highest VI values. The space along the waterfront has higher visibility and have higher VI respectively. These spaces are used mostly for different social activities by the people of the neighbourhoods around. When the disconnected roads in this area are connected with the waterfront area the integration value increases in the neighbourhood and confirms that open space especially attributed with a water body increases visibility and different social interactions of the female and children's and increase social integration.

Focusing on urban open green spaces, this paper studies spatial interaction between different social groups in the neighbourhood of *Dholaikhal* area of old Dhaka. As visual characters of these social spaces have an effect on its use and social interaction, the findings of this study will contribute in creating awareness among the architects, policymakers and builders regarding the need of socially integrated shared spaces to ensure community interaction and enhancing spatial interaction.

Acknowledgements

This paper based on the field study of the authors conducted in August 2018, for Arch 6303(Domestic Architecture) in the Department of Architecture, Bangladesh University of Engineering & Technology (BUET), Dhaka-1000.

References

- Gomes, C.D.**, 2016, *Segregation in Domestic Spatial Organization of the Contemporary Middle-Income Group Apartments of Dhaka*, Protibesh, Journal of the Department of Architecture BUET, vol. 16 no. 01, Jan 2016.
- Gomes, C.D.**, 2015, *Visibility Effecting Gender Aspects in the Middle-Income Group Apartments in Dhaka*, International Space Syntax Symposium 10, London.
- Gomes, C. D.** and **Nilufar, F.**, 2012, *Understanding Privacy in Domestic Space: A Study of the transformation of Urban Houses in the context of Dhaka*, Cities in Transformation- Research & Design: Ideas, Methods, Tools, Techniques, Case Studies. EAAE/ ARCC International Conference on Architectural Research, Politecnico di Milano, Temi, Theme 4, no.7:362-365.
- Glass, Ruth** (1948), *The Social Background of a Plan. A Study of Middlesborough*. London: Routledge and Kegan Paul.
- Khan, Iftekher M.** (1982), "Alternative Approach to the Redevelopment of Old Dacca", Unpublished Doctoral Dissertation, Katholieke Universiteit Leuven.
- Md Shehab U**, 2002, *Dholaikhal rehabilitation project—achievement of objectives Bangladesh*, 28th WEDC Conference Kolkata (Calcutta), India,
- Mumford, L.** (1968), *The Urban Prospect*, London: Secker & Warbury.
- Nilufar, F.** 2004, *Hidden Morphological Order in an Organic City*, Protibesh, Journal of the Department of Architecture BUET, vol. 9, 2004, 32-34
- Rapoport, Amos** (1977), *Human Aspects of Urban Form*, Oxford: Pergamon.
- Raman, S.**, 2010, *Designing a Liveable Compact City: Physical Forms of City and Social Life in Urban Neighbourhoods*, Built Environment, Volume 36, No. 1, 30, Alexandrine Press, pp. 63-80(18) <https://doi.org/10.2148/benv.36.1.63>
- Reynald, D. M., & Elffers, H.** (2009). The future of Newman's defensible space theory: Linking defensible space and the routine activities of place. *European Journal of Criminology*, 6(1), 25-46
- Schoenaues, Norbert** (1981), *6000 Years of Housing: The Oriental Urban House.*_Vol: 2. New York: Garland STPM.
- Turner, A.**, 2003, "Depth map: A Program to Perform Visibility Graph Analysis", J. Hanson (Ed.), Proceedings, 4th International Space Syntax Symposium, London.
- Turner, A., Doxa, M., O'Sullivan, D. and Penn, A.**, 2001, "From Isovist to Visibility Graphs", Environment and Planning, B, 28(1):103-120.
- Williams, Jo** (2005) *Designing Neighbourhoods for Social Interaction: The Case of Cohousing*, Journal of Urban Design, 10:2,195-227; <http://dx.doi.org/10.1080/13574800500086998>

Samarawickrama, Sumanthri, et al (eds), 2018, "Sustainability for people - envisaging multi disciplinary solution": *Proceedings of the 11th International Conference of Faculty of Architecture Research Unit (FARU), University of Moratuwa, Sri Lanka, December 08, 2018 Galle* pp. 50–58. ©

IMPACT OF SPATIAL PERCEPTION ON PLACEMAKING IN OPEN SPACES OF MIDDLE CLASS HOUSING SCHEMES AROUND COLOMBO

MANAWADU T.¹ & DHARMASENA J.²

^{1,2} University of Moratuwa, Moratuwa, Sri Lanka

¹manawadu.tharindu@gmail.com, ²jdarch@outlook.com

Abstract

Mass housing is used to provide not only a home but a social structure for communities. People celebrate their lifestyle using available spaces in these mass housings. This research aims to understand how spatial perception act on the placemaking process in this open spaces. This research mainly focuses on middle income housing which ensure the applicability of outcome to a broader spectrum. These communities may override designer's idea for a space and built their own. It is pertinent to create a middle ground between these informal place making process and formal design practice of professionals. Research was carried out by analyzing the activities in these open spaces through a photographic survey. Then different case studies were compared to accomplish the outcome. According to research findings dwellers prefer a more centralized establishment plus close proximity of nodes. When dwellers can experience the open space as one whole it act positively. When open spaces of a housing scheme failed to depict a sense of territoriality it becomes vulnerable to negative social influences. These patterns were clearly visible in all three case studies.

Keywords: *placemaking, spatial perception, mass housing, middle income.*

Introduction

Across the globe towns and cities become congested of overpopulation. Multi story housing schemes are one way to answer this issue. In Sri Lanka most of these housing schemes are based around Colombo with a variety of ethnic groups living in them which support to enhance the findings of this study. The open spaces of this housing schemes which facilitate the interaction within the community becomes the soul of these communities. Functionality and aliveness of these spaces provide strength to community life. We often see these communities ignore designer's intention for a spaces and built their own. In this process sometimes there are abandoned spaces which are hazardous. In this study author mainly focus on how the spatial perception impact on this placemaking process. Study is based around middle income housing because in "Death and Life of Great American Cities" jane Jacobs explain how middle income dweller is the most effective point to anchor a society and elevate the quality of life of it. The expected outcome of the study is to provide guidance in future development to in cooperate these placemaking process by community at the design stage of a project. To proceed further it may be helpful to understand the concepts of "Placemaking", "House" and "Place".

Introduction to "Placemaking"

Placemaking can be identified as making spaces in to places which can be used by people. "The way in which all of us as human beings' transformation of the place in which we find ourselves in to places in which we live"(Lombard, 2014). Placemaking is more than mere happening of a place it goes beyond than that. Placemaking is an important aspect for designers because people which deal with that space bear the responsibility of enabling the space in to a place.

Scholars Idea about "Placemaking"

One way scholars elaborate placemaking is by take it in to account as a process which make places out of spaces.

“ Placemaking is the process which a space in a location is made meaningful to an individual or a group” (Dayaratne, 1992)

“ In some ways, it appears that places are not created or made at all. Rather it may be seen that certain parts of the urban environment acquires a potential for becoming special through the existence of certain behavior patterns or through having significant attributes for them. Once in existence this potential can be realized or enhanced by the designer. ” (Sime, 1985)

“ Placemaking must be involved with creating something special out of or within space.” (Sime, 1985)“ Placemaking is fundamental to human habitation and occur whenever people will inhabit a piece of ground or space ” (Dayaratne, 1992)

“ Architecture is the both product and process of human habitation, and attempts are made to develop mechanisms and methods of designing spaces which can grow with people and their attitudes and therefore becoming meaningful places. ” (Habracken, 1972)

On the other hand some scholars argue placemaking as an tool for converging people and generating an experience through that.

“ Place is center of meaning, an organized world of meaning, constructed by experience. ” (Tuan, 1977)

“ Enabling places is what in contrast, all of the best architecture should aspire to even if this is different to achieve without the involvement of the dweller themselves. ” (Dayaratne, 1992)

“ Man is man’s greatest joy. Design for him. ” (Gehl, 1987)

“ What attracts people most it would appear is other people.” (Whyte, 1980)

“ The sight of people attracts other people is something that city planners and city architectural designers seem to find incomprehensible. They operate on the premise that city people seek the sight of emptiness, obvious order and quite. Nothing could be less true. The presence of great number of people gathered together in cities should not only be frankly accepted as a physical fact they should also be enjoyed as an asset and their presence celebrated. ” (Jacobs, 1961)

Concept of House

House is the single unit of the existence of man. it is the place he live and has the ability to control and live. It is the closest place to his heart. The house make a human being feel secure. Further people build attachment to this material entity. Over time with the attachment build up through daily interaction then it becomes the symbol of their existence. “ People feel proud and happy to be living in them and would not give them up for anything because they are their houses, because they are the products of their lives because the house is everything to them. The concrete expression of their place in the world, the concrete expression of themselves. ” (Christopher, 1987). House is the center of dweller which he finds at ease. “ As One experience the meaningful events of existence, a place become a center of action. ” (Norberg-Schulz, 1980).

Concept of Place

The discussion of “ concept of place ” began far back as the era of Greek philosophy in the history. In that era the great philosopher Aristotle explained the concept of place as, “ Where dimension of people relationships to physical environment conjuring a feeling of belongingness. ” According to some scholars place can be understand as the activities which take place on a certain space that give a certain atmosphere to a space in simple terms “ happening of a place ” which creates a personal attachment to a space.

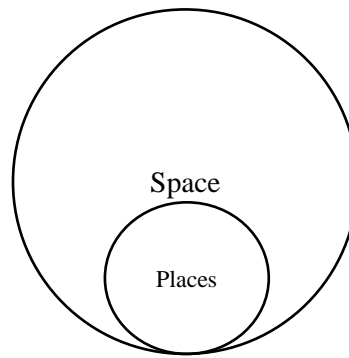

Figure 6, Places as a part of space
(Compiled by author)

Theoretical Framework

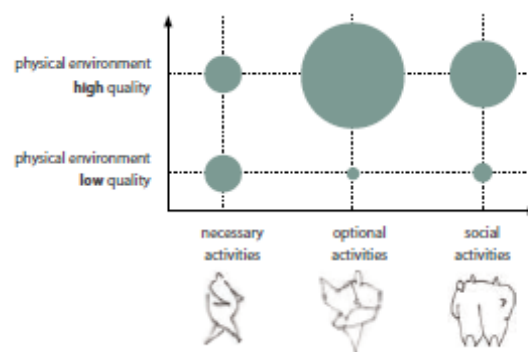

Figure 7, Graphic representation of the connection
(Source: Cities for People)

Place making can be quite diverse in a housing scheme. Even though place making is quite a qualitative process. To understand and analyze it among different case studies and come to a conclusion research process need a quantitative approach. In search of theoretical and quantitative method to assess the quality of an open space to placemaking point towards the book “ Cities For People ”. In it Jan Gehl develop a method which he use to assess the quality of an open space. First he breakdown activities under three categories. Through the quantity of people involved in each group of activity it can conclude the impact of space on generating activities.

Necessary Activities

“ Necessary activities are an integrated, non-optional part of every day. Here we have no choice. Activities that people have to undertake. Going to work or school, waiting for the bus, bringing goods to customers. These activities take place under all conditions. ” (Gehl, 2010)

Optional Activities

“ Optional activities are recreational and fun. City quality is a decisive perquisite for this important group of activities like this. Walkers are tempted to stop to enjoy the weather, places and life in the city, or people emerge from their buildings to stay in city space. Chairs are dragged out in front of houses and children come out to play. ” (Gehl, 2010)

Social Activities

“ Social Activities include all types of contact between people and take place anywhere people go in city space. Social activities include a wide spectrum of diverse activities. People exchange greetings and talk to acquaintances they meet. New topics and common interests can be discussed. Acquaintanceship can sprout. ” (Gehl, 2010)

Graph express a qualitative idea about the space. This graph can be used to compare two case studies and get a deeper understanding. And understand the impact of spatial perception on placemaking with in a one case study by comparing the quantity of different groups. This also help to achieve a deeper understanding. Next topic explain the methodology to achieve this.

Methodology

The objective was to understand the above process and formulate some pointers for future designers such as landscape architects and architects. The research was carried out in a quantitative process using a photographic survey conducted by author.

The outcome of the photographic survey was then analyzed under three different groups of activities. And through that formulated a one graph for each case study which can express the quality of its open spaces. Then these were compared with itself and each other and through an analytical process came to findings of how spatial perception effect on placemaking in open spaces.

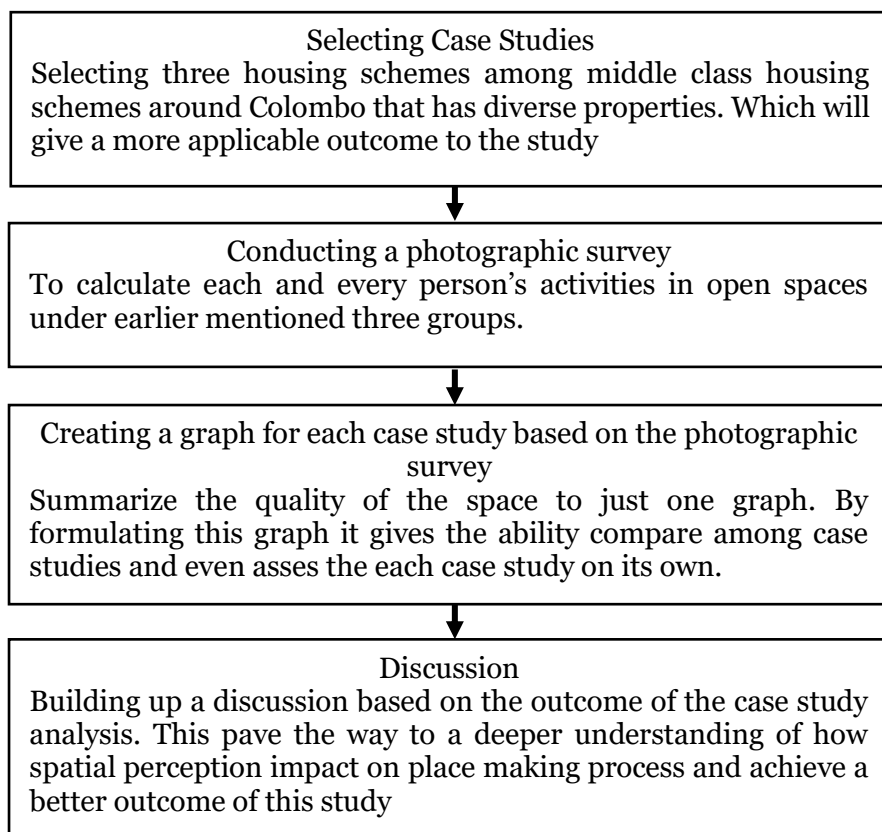

Case Studies

The case studies were selected capturing different aspects of middle class housing schemes. Which were both in Colombo municipal council area and outskirts of Colombo. Both vertical development and horizontal development were selected in variation of different scales.

Soysapura Housing Scheme at Ratmalana

	Necessary Activities	09
	Optional Activities	77
	Social Activities	17

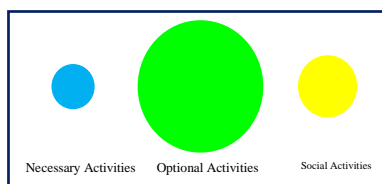

Figure 8, Formulated graph for soysapura housing scheme (Compiled by Author)

Mattegoda Housing Scheme at Mattegoda

■	Necessary Activities	36
■	Optional Activities	20
■	Social Activities	07

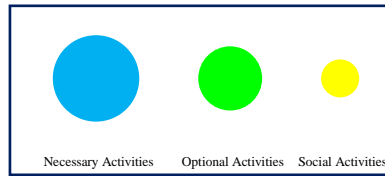

Figure 9, Formulated graph for mattegoda housing scheme (Compiled by Author)

Anderson Flats at Narahenpita

■	Necessary Activities	05
■	Optional Activities	04
■	Social Activities	00

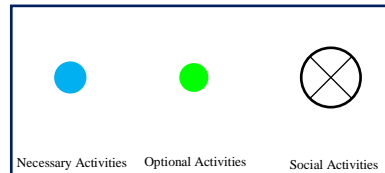

Figure 10, Formulated graph for anderson flats (Compiled by Author)

Dominance of Centralized Organization in Open Space in Building a Good Neighborhood

Social activities are the ones that build up relationship among the members of a community which ultimately make way for a good lively neighborhood. As noticed in the case studies the only housing scheme that has signs of good neighborhood with good social life is Soysapura housing scheme. It has a good amount of social activities in compare with other activities.

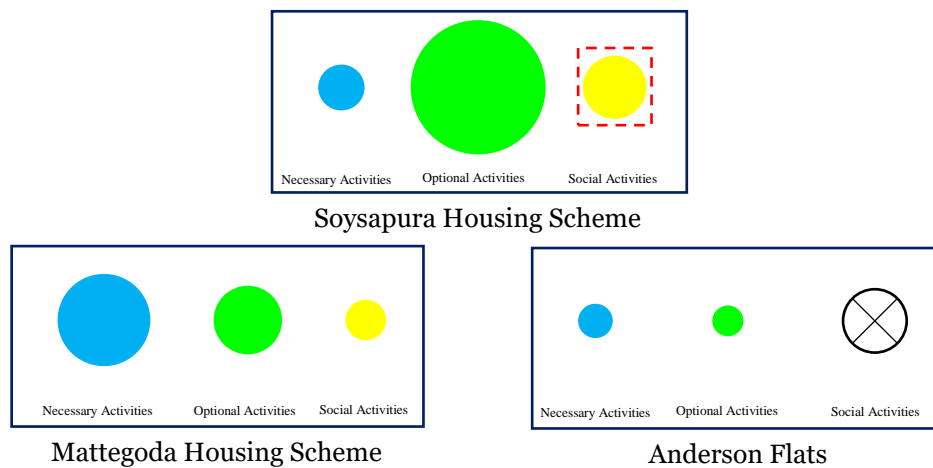

Figure 6, Dominance of soysapura housing scheme in social activities (Compiled by Author)

The thing to notice is Mattegoda housing scheme has a much larger foot print compared to Soysapura housing scheme which with much more open spaces. But Soysapura housing scheme has more social activities than Mattegoda housing scheme.

The reason for this is the centralized organization of dwellings around the central open space. It provide accessibility and permeability for dwellers and hence create a place which can be attached socially to dwellers.

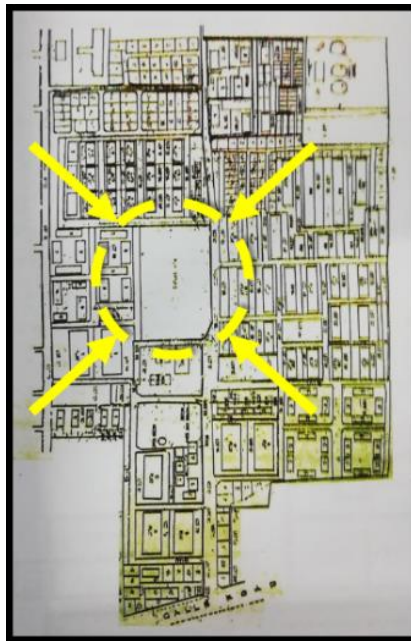

Figure 7, Centralized organization of soysapura housing scheme
(Compiled by Author)

Centralized Organization

This is a much stable and concentrated composition which accompany secondary spaces around a large dominant central space. These secondary spaces might have same function or different from each other. Same way they can be identical in form and space or differ. This flexibility of secondary spaces allow central space to respond to varying conditions.

Social Decay Due to Lack of Territoriality

The most noticeable thing in the study concluded in Anderson flats where its absence of social activity in open spaces of it compared to other case studies. The reason for that is the bad social influences such as drug abuse and thievery in surrounding neighborhood. According to literally sources it was a well-functioning housing scheme before this ill fate. Even though it is currently occupied by the families of military personal. People doesn't get out much and the open spaces can be taken as examples for dead spaces.

As the author identified the reason for this dead spaces is the social decay caused in the absence of territoriality. This housing scheme doesn't have much for demarcation of boundaries in physical form or psychological form. Boundaries are mostly consist of roads which are publically accessible. The other factor is it's rather fragmented with a few blocks being located separately and this void again become a catalyst for said process. So according to analyze when there is a lack of territoriality and fail to demarcate boundaries for outsiders. It's possible for bad factors to influence the social life of dwellers in a middle class housing scheme

Territoriality

“ The territoriality makes life easier and secure. This need for security may be one of the reasons why man had to demarcate “place”. ” (Rapoport, 1969). So we can understand the territoriality aspect of a particular place contributes to its secure quality. Naturally we feel comfortable in demarcated spaces

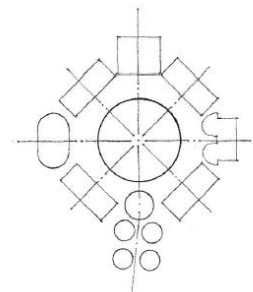

Figure 8, Illustration of a centralized Organization
(Source: Form, Space and Order)

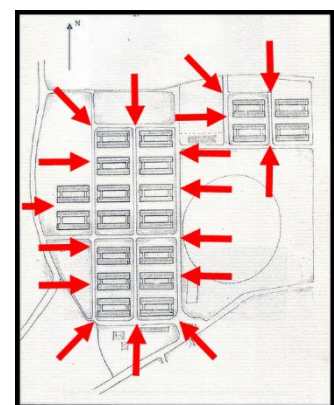

Figure 9, Negative social impact on anderson flats
(Compiled by Author)

thus man establish his belongingness to a certain place considering its territoriality because he feel comfortable and secure.



Figure 10, Demarcated boundaries in a neighbourhood
(Source: Genius Loci)

Decreasing of Activities in Clustered Open Spaces

When consider about optional activities which are recreational activities. Those are a direct impression of quality of a space. Noticeably there is a lacking of users of optional activities in Mattegoda housing scheme compared to Soysapura housing scheme. This is quite unique considering Mattegoda housing scheme has a much bigger foot print and more open spaces which directly support recreational activities.

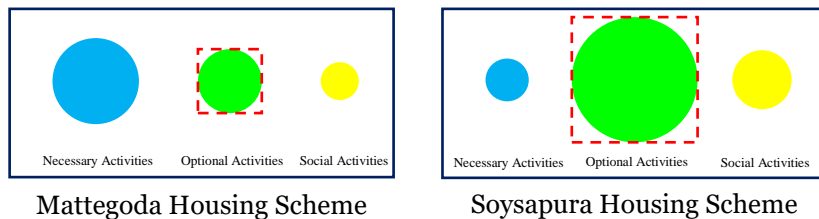

Figure 11, Decrease of activities in clustered open spaces
(Compiled by Author)



Figure 12, Comparison of open spaces
(Compiled by Author)

So by comparing the layout of both schemes reveal that Mattegoda housing scheme has much more scattered set of open spaces while Soysapura housing scheme has a one big dominant open space. Because of this scale this space has a character more than spaces of Mattegoda. The other thing is one activity of this space can create a chain reaction and attract many more people to this space and make it alive. Because spaces becomes alive from edges to center as Jan Ghel mentioned in his book “ Cities

for People ”. On the other hand open spaces of Mattegoda housing scheme lacks a character to space due to small sizes. Furthermore it require more catalyst activities than a one single open space since there is no direct linkage between them. So because of above conditions having one relatively big open space is better in a middle income housing scheme rather than having few small ones.

Close Proximity of Nodes Increasing Social Activities

Between Mattegoda Housing Scheme and Soysapura Housing Scheme it is clear that there is an increase of social activities. This is noticeable because mattegoda has relatively much more open spaces and due to that should have been more socially function. The other thing to know that also is mattegoda housing scheme also has a bigger foot print. Anderson Flats wasn't taken into account due to its absence of social activities caused by outside factors.

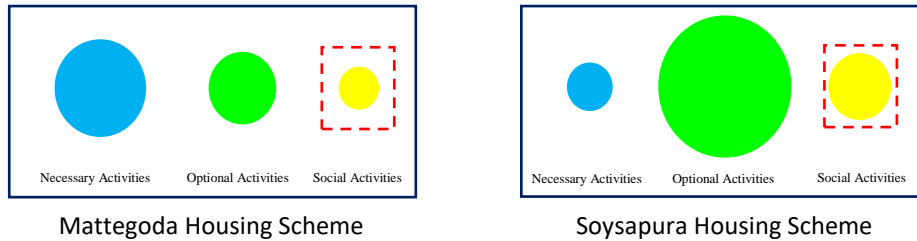

Figure 13, A comparison of social activities
(Compiled by Author)

So through this comparison it's clearly visible there is a substantial lack of social activities in Mattegoda Housing Scheme. Now we will look in to where social activities were present in Soysapura Housing Scheme.



Figure 14, Social active spaces
(Compiled by Author)

It can be identified that all the places that has substantial social activities are close to nodes of the premises. Next analyze the difference of position of nodes between these two case studies.



Figure 15, Comparison of nodes close to open spaces
(Compiled by Author)

From comparison it's clearly visible that Soysapura Housing Scheme's location of nodes are much denser close to open spaces. In contrast nodes of Mattegoda housing scheme is much wider spread compared to its relative bigger footprint. So through this analysis come to the conclusion that a denser position of nodes close to an open space lead to improve the social activities of a middle class housing scheme.

Nodes

Buildings, spaces that are the focus of pedestrians and can be physically entered. Which are the organized focal points and from which the person is travelling. Nodes can be junctions, places where transportation has a break, a crossing or merging of paths or they can simply be gathering spaces such as a public square or a hangout corner. Most nodes are both junctions and concentration.



Figure 16, Abstract illustration of a node (Source: Image of The City)

Conclusion

Looking in to how spatial perception impact on placemaking in open spaces of middle class housing schemes and create a clear picture about it was interesting. The findings of the research explain how it's important to consider placemaking process in a neighborhood. It is evident that in a central organization makes the best possible scenario. In one particular case study clearly expressed that how lack of placemaking in a neighborhood can cause to social decay and establishment of negative factors for lives of dwellers.

At the end of the study finally was able to formulate some pointers through analytical process on my collected and processed data. Author expect these can be guidance to future designers who are going to develop middle income mass housing. Author believe most of them are still applicable to other forms of housing also.

When designing dwellings designers also have to think of the dweller who is entangled with a social life. Because humans naturally live in groups. So its great important to understand this in design of dwellings. It's not just what you designing. You have to look at the big picture. How little and little pieces come together and form a society in a neighborhood. This is the most vital message that Author expect to deliver through this research.

Reference

- Christopher, A. (1987). *A New Theory of Urban Design*. Oxford: Oxford University Press.
- Dayaratne, R. (1992). *Supporting People's Placemaking*. Tyne: Newcastle University.
- Gehl, J. (1987). *Life Between Buildings: Using Public Space*. New York: Van Nostrand Reinhold.
- Gehl, J. (2010). *Cities for People*. Island Press.
- Habraken, J. (1972). *Supports: An Alternative to Mass Housing*. London: The Architectural Press.
- Jacobs, J. (1961). *The Death and Life of Great American Cities*. New York: Random House.
- Lombard, M. (2014). Constructing ordinary places. *Progress in Planning*, 94, 10–17.
- Norberg-Schulz, C. (1980). *Genius loci: towards a phenomenology of architecture*. New York: Rizzoli.
- Rapoport, A. (1969). *House form and culture*. New Jersey: Prentice-Hall.
- Sime, J. (1985). Creating places or designing spaces? In *Place and Placemaking*. Melbourne.
- Tuan, Y.-F. (1977). *Space and Place*. London: Edward Arnold Publishers Ltd.
- Whyte, W. H. (1980). *The Social Life of Small Urban Spaces*. Conservation Foundation.

Samarawickrama, Sumanthri, et al (eds), 2018, "Sustainability for people - envisaging multi disciplinary solution": *Proceedings of the 11th International Conference of Faculty of Architecture Research Unit (FARU), University of Moratuwa, Sri Lanka, December 08, 2018* Galle pp. 59–65. ©

POSSIBILITY OF RECYCLING PLASTICS FROM MUNICIPAL SOLID WASTE (MSW) AND THEIR POTENTIAL APPLICATIONS IN CONSTRUCTION INDUSTRY

JAYATHILAKA W.M.D.S.¹, CHANDRASENA N.², PREMACHANDRA J.³ & HALWATURA R.U.⁴

^{1,3,4}University of Moratuwa, Moratuwa, Sri Lanka

²Sri Lanka Land Reclamation and Development Corporation, Rajagiriya, Sri Lanka

¹dilinisandarekha@gmail.com, ²nadeeshachandrasena@gmail.com, ³jagathp@gmail.com, ⁴rangikauh@gmail.com

Abstract

The rate of resource consumption today is more than the rate of generation in natural resources. In developing countries, municipal solid waste (MSW) is a growing problem due to heterogeneous composition, non-biodegradability of plastic waste, lack of recycling facilities, high cost of waste collection, transportation and management and the environmental problems arising from the dumping of waste. Plastics widely used in the food packaging industry. The waste of growing plastics in urban areas presents health and environmental problems. . Construction materials play a key role in construction projects. At the moment, most of the projects focus on the development of construction materials that use waste. The objective of this article is to review the possibility of recycling the plastics that are generated in the MSW and its possible applications in the construction industry. This paper discusses the composition of MSW and plastic waste components in Sri Lanka. Primary, secondary, tertiary and quaternary technologies are considered for the recycling of plastic waste and plastic waste applications in the development of innovative construction materials. The use of municipal waste generated in Sri Lanka for the manufacture of construction materials will help reduce the problems associated with waste in the country. As a sustainable solution to this problem, the development of construction material with waste material is a possible option to address this problem. Recycling can be beneficial, since its energy efficiency reduces the waste generated, reduces the problems related to waste in the country, and studies have investigated the use of waste for construction in the industry.

Keywords: *Municipal solid waste, Plastic waste, Construction material, Recycling waste*

1. Introduction to waste

Population growth and urbanization have increased the municipal solid waste (MSW) quantity in Sri Lanka. Numerous types of waste management techniques which are currently in use (such as land filling, composting, anaerobic digestion, incineration, etc.) do not seem to be sufficient enough, considering the rate at which waste is generated in Sri Lanka. The solid Waste collection is done by Municipal Councils, Urban Councils, Pradeshiya Sabha and the private sector in the country. In Sri Lanka daily collection amount of solid waste is 3242 MT. The collection of SW in Western Province is around 1783 MT, which includes 1284 MT collected from Colombo District. Per capita, daily generation of solid waste are 0.8 kg/person for Colombo district, 0.7 kg/ person for Municipal councils, 0.6 kg/person for Urban councils and 0.4 kg/person for Pradeshiya sabas.(Hikkaduwa *et al.*, 2015)(Poulakis and Papaspyrides, 1995). Considering other local authorities, the largest amount of MSW collection and generation is at Colombo area due to increasing urbanization, high population density with a high rate of population growth. According to the "Pilisaru" National Solid Waste management programme in Sri Lanka in 2012, the composition of the Municipal Solid Waste is as follows (Central Environmental Authority, 2008).

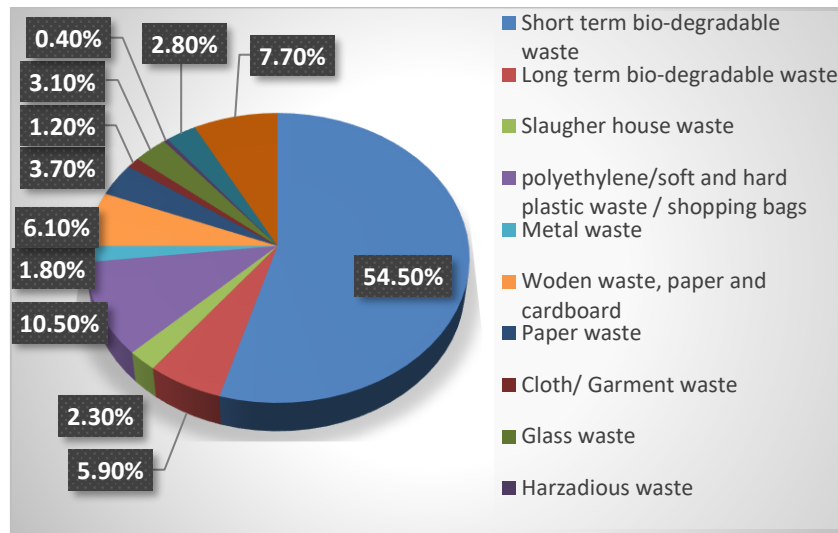

Figure 1, MSW compositions in Sri Lanka

According to Figure 1, the largest composition of MSW is short-term biodegradable waste, which is more than 50% of the total amount. Polyethylene, soft and hard plastic account for around 10% of the total, which is the second largest waste regarding quantity and one of the world's most problematic waste due to non-biodegradability.

2. Waste management in Sri Lanka

Any country should have a proper waste management system to minimize the social and environmental effects of waste. In developing countries, most of the MSW generated end up in open dumps, causing many environmental problems. Emissions, leachate generation, heavy metals in the leachate, soil contamination surrounding waste landfills are the main problems due to landfilling (Bandara and Hettiarachchi, 2003). Therefore, an effective waste management system is needed for the country. The primary considerations of a waste management system are; waste generation, waste collection, and transportation, intermediate treatments, final disposal of waste (Malwana, 2008).

2.1. WASTE GENERATION

Solid waste generation in Sri Lanka is mainly due to household and industrial activities. Minimization of waste generation will eventually minimize the load on the other components of a waste management system, and hence the cost is reduced. According to the waste management hierarchy, the waste management options include; avoiding waste, reducing waste, reuse, and recycling of waste, recovering, and final disposal of waste (Africa and Outlook, 2012). The most preferred options are avoiding and reduction of waste because avoidance and reduction of usage can impact the production capacities in the product and obviously the final disposal quantities. Reuse and recycling eliminate waste disposal quantities by maximizing the value of materials.

2.2 WASTE COLLECTION AND TRANSPORTATION

In Sri Lanka, Municipal Councils, Urban Councils, and Pradeshiya Sabhas responsible for solid waste collection and management in the country. In local authorities, there are more than 8000 employees employed with special dumping trucks, four-wheeled tractors, two-wheeled tractors, hand carts and other equipment for waste collection. For waste segregation, ministry of environment has used national colour codes for waste collection containers; Green – Biodegradable waste such as kitchen waste, garden waste and food waste, Blue – paper waste, Orange – Plastic waste, Red – Glass waste, Brown – Metal and coconut shells (Malwana, 2008). Normally, municipal solid waste is collected and transported to dumping places like Kerawalapitiya and Meethotamulla.

2.3 INTERMEDIATE TREATMENTS AND WASTE DISPOSAL FACILITIES

There are no proper waste disposal facilities in Sri Lanka. As a result, most of the solid waste collected

will be disposed of using open dumping. Organic waste which consists of naturally degrading organic compounds can be converted into methane, compost and some of the organic waste can be fed animals. Paper and cardboard waste which is made out of organic waste can be recycled or reused. It can be composted if recycling or reuse is not possible. Paper and cardboards printed using ink may require some caution. Glass, metals, and plastic wastes can be recycled, re-used or may be used for other purposes as well. After discarding, the glass will be subjected to slow mechanical degradation due to silicate (SiO_2) and turned into the sand after and many decades. Other silicate materials such as ceramics are inert materials, and some materials may contain heavy metals. Therefore mechanical and chemical degradation will happen to degrade those materials into the sand. Polythene/ soft and hard plastic waste/ shopping bags are major problem in the country (Zon and Siriwardena, 2000).

3. Plastic wastes in MSW

Plastics are synthetic polymers originating from crude oil. Plastics often used for packaging purposes because of its properties such as light weight, availability of different types, etc. The most common plastic types found in MSW are; Polyethylene (1. High-density polyethylene (HDPE), 2. Low-density polyethylene (LDPE)), Polypropylene (PP), Polyethylene terephthalate (PET), Polystyrene (PS) (Meran, Ozturk and Yuksel, 2008)(Sulyman, Haponiuk and Formela, 2016). Polyethylene (PE) or Polythene is a thermoplastic polymer used in varieties of applications. It has a simple chemical formula of $(\text{C}_2\text{H}_4)_n$, and it can be used for packaging of grocery bags, shampoo bottles, toys, piping, bullet propping vessels, etc. (Rahimi and García, 2017). Polyethylene is classified into various categories. Among those, the most important grades of polyethylene are low-density polyethylene (LDPE), linear low-density polyethylene (LLDPE), and high-density polyethylene (HDPE) (Version, 2015). Poly bags which are made out of polyethylene pellets are manufactured using blown film extrusion method. During the manufacturing process, PE is subjected to many additives such as anti-block agents, slip agents, and UV inhibitors. PE is a semi-crystalline polymer used for varieties of applications due to low cost and ease of fabrication. PE can be either a homogeneous polymer or a copolymer (Gopura, 2008). Polypropylene is a polymer made of propylene monomer, which is used for various applications such as packaging, etc. Thermoplastic resin with semi-crystalline structure, opaque and tough elastic properties increase the use of PP in packaging applications. Propylene is a tough, rigid plastics produced using radical or catalytic polymerization (Meran, Ozturk and Yuksel, 2008). Polymerization of PP is done using gas phase or liquid phase. PET is a transparent thermoplastic polyester with good mechanical properties, good chemical resistance, dimensional stability under variable load, and good gas barrier properties. PET is used for bottle manufacturing, thermally stabilized films and production of fibers in textile industry (Sulyman, Haponiuk and Formela, 2016).

4. Recycling and recovery of plastic solid waste

Plastics usage increases daily due to its easiness, light weight, low cost and other benefits such as processability. As the consumption increases, waste generation also increases proportionally. Due to lack of recycling and reuse of plastic waste, final disposal quantity is increased, and hence, obviously environmental and other problems will rise. Plastic waste recycling promotes the conservation of raw petrochemicals and energy. However, there are many constraints which limit the plastic waste recycling economically and technically. Contamination of plastic waste with other materials which can damage the equipment being used for the processing, plastic waste feedstock not being homogeneous, variation due to factors such as time, location, etc., plastics are varied with polymer grades, etc (Rebeiz and Craft, 1995). There are four main methodologies for plastic waste recycling and recovering; Primary method - re-extrusion, Secondary method – Mechanical, Tertiary method – Chemical, Quaternary method - Energy recovery (Lettieri and Baeyens, 2009) (Poulakis and Papaspyrides, 1995). Plastics which has similar properties to the original material is used in this method by re-introducing to the extrusion cycle. In-plant recycling which is re-introduction of scrap materials to the processing cycle is falling to the primary method. Ex: - Injection Molding. Mechanical recycling involves the recovery of plastics form waste for re-use in the manufacturing process. This method is applicable only for the single polymer plastics such as PP, PE, PS, etc. The existing stages of mechanical recycling of plastics are; Cutting/Shredding, Contaminant Separation, floating, Milling, Washing and drying, Agglutination using pigments and additives, Extrusion, Quenching and granulation (Aznar *et al.*, 2006).

Chemical recycling or feedstock recycling refers to the transformation of plastic polymers using heat and other chemical agents to convert them into monomers or other hydrocarbons (Aznar *et al.*, 2006). When mechanical recycling is not feasible, chemical recycling is used to convert waste plastics into different products. Chemical processes such as gasification cracking, liquefaction, etc. are obtained to depolymerize the plastics into oil. Chemical processes that used to recycling the plastic waste are; Thermolysis refers to the treatment of plastic waste using heat with a controlled environment of temperature without presenting a catalyst. It can be divided into three major categories; Pyrolysis, Gasification, Hydrogenation (Lettieri and Baeyens, 2009)(Aznar *et al.*, 2006). In pyrolysis method, thermal cracking is done using an inert atmosphere. The gas which is having high calorific value and high purity can be produced using wide variations of waste streams. The gas produced can use in gas engines, boiler applications without doing flue gas treatments. Considering both pyrolysis and gasification methods produce solid, liquid and gas phase. Degradative extrusion: In this method thermoplastics are break down into low viscosity molecular by introducing steam, gas, oxygen or catalyst as needed. Chemical depolymerisation: Plastic polymers react with chemicals to depolymerize them into the monomers which can be used to produce new polymers for the production of polymers or fuels. Depending on the chemical agent methanolysis, hydrolysis, ammonolysis, and glycolysis are the most common methods used for condensation polymers such as PET (Aznar *et al.*, 2006).

Using incineration MSW volume is reduced by generating energy in the form of heat, steam, and electricity. Incineration creates several of environmental problems such as air pollution due to the emission of CO₂, NO_x, SO_x, and generation of airborne particulars such as VOCs (Poulakis and Papaspyrides, 1995)(Cheng and Hu, 2010).

4.1 MECHANICAL AND CHEMICAL RECYCLING OF PLASTIC WASTE

PE and PET are an addition and condensation polymers respectively, which cannot be easily recycled using chemicals. For PET bottle recycling mechanical and chemical methods are used. In mechanical recycling waste is collected, sorted, washed and conditioning the plastics to get clear grades of PET which can be mixed with virgin PET materials. Plastic conversion techniques which used in mechanical recycling are Extrusion molding, Injection molding, Blow molding, Vacuum moulding, Inflation molding (Kowalska, Wielgosz and Pelka, 2002).

Table 1, Waste LDPE and PVC from the packaging and cable industry are used for the production of different products.

Raw material	Product	Techniques
<ul style="list-style-type: none"> • < 50 wt% of LDPE from cable insulation • >50 wt% of comminuted rubber scrap • <0.1 wt% of blowing agent 	Porous hoses	Extrusion molding (Temperature should not exceed 190 °C)
<ul style="list-style-type: none"> • PP with various compositions of Phosphogypsum instead of talc 	Vehicle parts	Extrusion of granulate and injection molding
<ul style="list-style-type: none"> • PVC compositions with phosphogypsum as filler 	Flooring	Calendaring

Polyolefin (HDDPE, LDPE, and PP) can be dissolved using solvents such as xylene and toluene. LDPE can be dissolved using solvents such as benzene, toluene, chlorobenzene, isooctane, xylene, and trichloroethylene. Except isooctane other solvents are more suitable for dissolution of LLDPE. But the problem is above mentioned all the solvents are hazardous, and benzene is less suitable due to its safety precautions (See figure 2). Cyclohexane is also used for dissolution of HDPE in higher temperatures (Poulakis and Papaspyrides, 1995)(Wong, Ngadi and Abdullah, 2014).

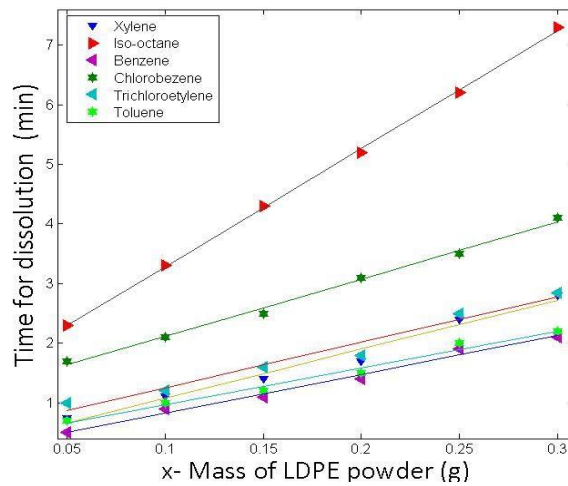

Figure 2, LDPE dissolution rates using different solvents (Wong, Ngadi and Abdullah, 2014)

Pyrolysis of plastic is done using a variety of reactors: fluidized bed reactors, batch reactors, and fixed bed reactors. Conical spouted bed reactor (CSBR) is a fluidized bed reactor using for large-scale plastic waste pyrolysis because of its low bed segregation, lower attrition compared to bubbling fluidized bed (D. S. et al Achilias, 1995). Catalytic pyrolysis using fixed bed reactor with a catalyst gives aliphatic hydrocarbons which can be used as a feedstock for refinery oils or plastic production. PET can be recycled using hydrolysis, glycolysis, aminolysis, alcoholysis, and acidolysis which using the reagents water, glycols, amines, alcohols, and acids respectively (D. S. Achilias, 1995). Plastics such as PET and nylon can be recycled using chemical depolymerization method.

5. Plastic waste used in construction industry

In the market, plastics provide a variety of applications. According to the European market, most of the plastics produced are used for packaging applications. Building and construction sector is the second largest consumer in the market. Automotive, Electrical and electronic applications, agriculture applications, household and consumer products are having a high demand for plastics (‘Plastics – the Facts 2014 / 2015 An analysis of European plastics production , demand and waste data’, 2015). Long life span and light weight increase the popularity of plastics used for construction applications. Plastics used in the construction industry for the applications of pipes and ducts, insulation purposes, windows profiles, flooring and wall coverings, lining, fitted furniture. Utilization of waste materials in the construction industry is one of a viable solution for the waste plastics found in MSW. Recycling of waste materials gives varieties of advantages such as energy conservation, reduce landfilling, cost, etc. In onstruction industry plastics wastes can be used in two ways; Reusing of components, Recycling of waste into the production of building materials (Bolden, Abu-Lebdeh and Fini, 2013).

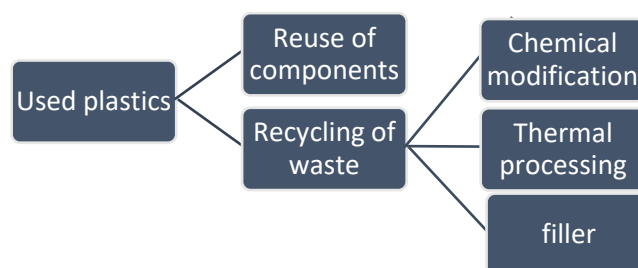

Figure 3, Plastic waste usage and recycling in the construction industry

In construction industry recycling methods of construction applications are the chemical modification, thermal processing, and fillers. Hydrolysis and pyrolysis are used to recycle plastics in the chemical modification to produce products such as bathtubs, automobile parts using the PET. In thermal processing, mechanical recycling methods are used to produce new products such as panels fibers for

carpeting, etc. (Bolden, Abu-Lebdeh and Fini, 2013). Recycled plastic mostly used for modification of asphalt and concretes, embankments and as an aggregate (Jassim, 2017). This method is using to fill the material in the applications. Cost, education, environment issues, quality of the material, contamination, separation issues, types of equipment, storage, availability, market are some challenges for recycling of materials.

Table 2, Summary of recycled waste used in construction industry.

Waste Material	Purpose	Reference
Waste plastics such as PET bottles partial substitution for fine aggregates	For modification of asphalt, cement, and concert	(Bolden, Abu-Lebdeh and Fini, 2013)
Waste HDPE packages includes bottle such as shampoo and food containers	Mixed with Portland cement to produce light weight cement replacing sand with fine PE waste	(Appiah, Berko-Boateng and Tagbor, 2017)
Waste HDPE a PP blended with the bitumen "in-situ."	Sing melt-blending technique bitumen was modified for road construction	(Rausch and Rausch, 2009)
Glass and High Impact Polystyrene	Modification of cement mortars	(Yesilata, Isiker and Turgut, 2009)
Waste PET bottles and rubber pieces	Thermal insulation enhancement in concrete	(Yesilata, Isiker and Turgut, 2009)

6. Conclusion

A large quantity of MSW is generated in Sri Lanka due to human activities in household and domestic. Plastic waste is the second largest in terms of composition in MSW which is a major problem in MSW. Disposal of plastic can cause serious environmental problems. The impact can be minimized through the recycling of plastic wastes into various applications. Resource conservation, energy conservation, and pollution minimization are other advantages of recycling plastics. Use of waste polymers for construction industry will help to reduce the production cost, modification in the quality of the product, and etc. Most of the recycled plastics are used for modification of asphalt and concrete.

7. References

- Achilias, D. S. (1995) 'Recent Advances in the Chemical Recycling of Polymers'.
- Achilias, D. S. et al (1995) 'Recent Advances in the Chemical Recycling of Polymers (PP, PS, LDPE, HDPE, PVC, PC, Nylon, PMMA)', pp. 1–62.
- Africa, S. and Outlook, E. (no date) 2 nd South Africa Environment Outlook.
- Appiah, J. K., Berko-Boateng, V. N. and Tagbor, T. A. (2017) 'Use of waste plastic materials for road construction in Ghana', Case Studies in Construction Materials. Elsevier Ltd., 6, pp. 1–7. doi: 10.1016/j.cscm.2016.11.001.
- Aznar, P. et al. (2006) 'Plastic waste elimination by co-gasification with coal and biomass in fluidized bed with air in pilot plant', 87, pp. 409–420. doi: 10.1016/j.fuproc.2005.09.006.
- Bandara, N. J. G. J. and Hettiarachchi, P. J. (2003) 'Environmental Impacts Associated with Current Waste Disposal Practices in a Municipality in Sri Lanka – A Case Study', pp. 19–26.
- Bolden, J., Abu-Lebdeh, T. and Fini, E. (2013) 'Utilization of recycled and waste materials in various construction applications', American Journal of Environmental Sciences, 9(1), pp. 14–24. doi: 10.3844/ajessp.2013.14.24.
- Central Environmental Authority (20AD) 'National Solid Waste Management Program In Sri Lanka'. Available at: <http://www.cea.lk/web/en/component/content/article?id=136:pilisaru-project-integrated-solid-waste-management-programme-si>.
- Cheng, H. and Hu, Y. (2010) 'Municipal solid waste (MSW) as a renewable source of energy: Current and future practices in China', Bioresource Technology. Elsevier Ltd, 101(11), pp. 3816–3824. doi: 10.1016/j.biortech.2010.01.040.
- Gopura, R. A. R. C. (2008) 'ANALYSIS AND SIMULATION OF A POLY BAG MANUFACTURING SYSTEM', (December).
- Hikkaduwa, H. N. et al. (2015) 'Sustainable Approaches to the Municipal Solid Waste Management in Sri Lanka', 6th International Conference on Structural Engineering and Construction Management 2015, (December), pp. 1–12.
- Jassim, A. K. (2017) 'Recycling of Polyethylene Waste to Produce Plastic Cement', Procedia Manufacturing. The Author(s), 8(October 2016), pp. 635–642. doi: 10.1016/j.promfg.2017.02.081.

- Kowalska, E., Wielgosz, Z. and Pelka, J. (2002) 'Use of Post-Life Waste and Production Waste in Thermoplastic Polymer Compositions', 10(1), pp. 83–92.
- Lettieri, P. and Baeyens, J. (2009) 'Recycling and recovery routes of plastic solid waste (PSW): A review', Waste Management. Elsevier Ltd, 29(10), pp. 2625–2643. doi: 10.1016/j.wasman.2009.06.004.
- Malwana, C. (2008) 'Solid Waste Management in Sri Lanka', Economic Review:, (July), pp. 34–37.
- Meran, C., Ozturk, O. and Yuksel, M. (2008) 'Materials & Design Examination of the possibility of recycling and utilizing recycled polyethylene and polypropylene', 29, pp. 701–705. doi: 10.1016/j.matdes.2007.02.007.
- 'Plastics – the Facts 2014 / 2015 An analysis of European plastics production , demand and waste data' (2015), pp. 1–34.
- Poulakis, J. G. and Papaspyrides, C. D. (1995) 'The Dissolution Reprecipitation Technique Applied on High-Density Polyethylene .1. Model Recycling Experiments', Advances in Polymer Technology, 14, pp. 237–242.
- Rahimi, A. and García, J. M. (2017) 'Chemical recycling of waste plastics for new materials production', Nature Reviews Chemistry, 1(6), p. 0046. doi: 10.1038/s41570-017-0046.
- Rausch, J. L. and Rausch, J. L. (2009) 'POLYETHYLENE-CYCLOHEXANE SYSTEM USING GRAVIMETRIC SORPTION ANALYSIS by', (May).
- Rebeiz, K. S. and Craft, A. P. (1995) 'Plastic waste management in construction: technological and institutional issues', Resources, Conservation and Recycling, 15(3–4), pp. 245–257. doi: 10.1016/0921-3449(95)00034-8.
- Sulyman, M., Haponiuk, J. and Formela, K. (2016) 'Utilization of Recycled Polyethylene Terephthalate (PET) in Engineering Utilization of Recycled Polyethylene Terephthalate (PET) in Engineering Materials : A Review', (November 2015). doi: 10.7763/IJESD.2016.V7.749.
- Version, D. (2015) Mechanical recycling of plastic packaging waste Mechanical Recycling of Plastic Packaging Waste. doi: 10.6100/IR783771.
- Wong, S. L., Ngadi, N. and Abdullah, T. A. T. (2014) 'Study on Dissolution of Low Density Polyethylene (LDPE)', Applied Mechanics and Materials, 695, pp. 170–173. doi: 10.4028/www.scientific.net/AMM.695.170.
- Yesilata, B., Isiker, Y. and Turgut, P. (2009) 'Thermal insulation enhancement in concretes by adding waste PET and rubber pieces', Construction and Building Materials. Elsevier Ltd, 23(5), pp. 1878–1882. doi: 10.1016/j.conbuildmat.2008.09.014.
- Zon, L. Van and Siriwardena, N. (2000) 'Garbage in Sri Lanka', Intergrated Resource Management Program Wetlands ,Sri Lanka, (October). Available at: <http://environmental.scum.org/slwaste>.

Samarawickrama, Sumanthri, et al (eds), 2018, "Sustainability for people - envisaging multi disciplinary solution": *Proceedings of the 11th International Conference of Faculty of Architecture Research Unit (FARU), University of Moratuwa, Sri Lanka, December 08, 2018* Galle pp. 66–73. ©

IMPROVE INTRINSIC PROPERTIES OF WALLING MATERIALS TO CREATE OCCUPANT COMFORT

GALKANDA. H¹, UDAWATTHA. C² & HALWATURA. R³

^{1,2,3}Department of Civil Engineering, University of Moratuwa, Moratuwa, Sri Lanka

¹himahansi.galkanda@gmail.com, ²udawatthe@gmail.com, ³rangikauh@gmail.com

Abstract

Buildings and architectural spaces are built for occupant comfort. Thus tropical climatic condition is the worst climate to achieve the occupant comfort. Tropics are favourable for bio receptive activities such as fungus and moss. Fungus and moss produce mycotoxins, spores and fragments which are toxic to occupants. However, the relationship between buildings envelopes and bio receptivity should be studied prior to find a sustainable solution. This study was conducted to understand the relationship with intrinsic properties of wall construction materials and the bio receptivity. The study was conducted after studying several intrinsic properties of walling materials such as organic matter content, surface roughness, water absorption and pH value according to laboratory test standards. Fungus and moss growth standard tests were conducted in the real world-controlled environment. Results of this study showed that surface roughness is the significant intrinsic property on bio receptivity. According to the test results fungus and moss growth on walling materials has a reciprocal connection with surface roughness values and no growth occurs on wall plasters where the surface is smoother. This study concluded that covering walls with cement plaster can reduce the growth of moss and fungus on tropical homes. Therefore smooth, plastered surfaces are best for homes with occupant comfort. But the cost of plastering might prevent poor families from acting on this concept. Therefore it is necessary to develop sustainable, cost effective and environmentally friendly wall, smoothing materials and techniques.

Keywords: *Intrinsic properties, Fungus, Moss, Occupant comfort, Walling materials*

1. Introduction

From the beginning of mankind used temporary and permanent shelters to secure their protection from extreme environmental and external conditions. With the civilization, conditions of shelters have developed and improved while making shelters as one of the major requirements of people. In the prehistoric time man used shelters with primitive technologies as primitive caves and it has developed with the time and development (Gray 2010, Singh et al. 2016). Therefore, primitive caves have developed to Kajan huts and to modern structural buildings. In present building construction sector is mainly focusing on building occupants comfort.

With the population growth and urbanization building constructions have developed and the average time that people spend in indoors has increased rapidly. There are two types of buildings as residential and commercial and it is found that people spent more than 80% of their lifetime, inside buildings (Al horr et al. 2016, Ismail et al. 2010, Moya et al. 2018). Therefore people expose to indoor environmental conditions more time of their lifetime and indoor environmental quality directly effects on building occupants health and comfort (Dylag 2017, Moya et al. 2018). Present building construction sector mainly focusing to improve indoor environmental conditions in order to create occupant comfort. Thermal, acoustic, visual, chemical, biological and air quality of the indoor environment should be improved in order to create occupant comfort (Al horr et al. 2016).

Building walls have a significant role in indoor environmental quality control to improve occupants comfort, as building walls are the boundary which separates indoor and outdoor environments of buildings (Moya et al. 2018, Udawattha et al. 2018). The external surface of building walls directly expose to outdoor environments while internal surface exposes to the indoor environment. Building walls create the building envelop which act as a thermal and acoustic barrier and create thermal and

acoustic comfort inside the building (Degrave-Lemeurs et al. 2018, Udawattha & Halwatura 2016). Indoor air quality is one of the most important factors which directly contribute to improving occupants' healthiness. Indoor air quality is affected by abiotic agents; such as dust, wall covering, volatile organic compounds, chemicals, paints and etc, and biotic agents; such as fungus, moss, bacteria, rat droppings, birds' droppings, pollen and etc (Haleem Khan & Mohan Karuppayil 2012). Under tropical climatic conditions, which consist of high humidity building walls tend to biological growth such as fungus and moss (Pranjic et al. 2015, Hoang et al. 2010).

Under favorable conditions such as moisture, optimal temperature and presence of organic matter, walling materials of buildings tend to fungus and moss growth. Therefore under tropical climatic conditions, water leaks and wetting of walling materials results in fungus and moss growth on the internal wall surface (Pranjic et al. 2015, Ozolins & Jakovics 2014). Presence of fungus and moss on the internal wall surface creates occupants discomfort in buildings (Dylag 2017). Fungus and moss growth create biological agents in the indoor environment which results in occupants discomfort (Haleem Khan & Mohan Karuppayil 2012).

Aspergillus, *Penicillium*, *Mucor*, *Rhizopus*, *Aureobasidium* and *Cladosporium* fungus species are the common fungus species identified in indoors (Żukiewicz-Sobczak et al. 2015, Mycol et al. 2016). Fungus and moss produce spores, Mycotoxins, volatile organic compounds and pollens as their metabolic products and release to the indoor air. And those products create adverse health impacts to occupants; such as allergies, respiratory problems, asthma, sick building syndrome, acute and chronic disorders (Dylag 2017, Baxi et al. 2016, Haleem Khan & Mohan Karuppayil 2012). Not only health effects but the effect of fungus and moss cause to reduce building occupants' physical fitness, mentality and productivity of their work (Kumar & Verma 2010). To avoid fungus and moss growth in the indoor environment of buildings most commonly use chemicals in the present.

Existing moss on walling materials is removed by removing moss and spraying chemicals. Zinc chloride, zinc sulphate and copper naphthenate are the most effective chemicals used to control moss growth (Ramsay 2003). Ammonium sulphate uses to burn out of the existing moss on walling materials. Some pesticides and herbicides also used to kill existing moss and inhibit the re-growth for a period of time (Safiuddin 2017; Ramsay 2003). To control the existing fungus growth on walling materials commonly use chemicals. Most commonly used anti fungus additives are sodium polyborate, iodopropinylbutylcarbamate (IPBC) and dichlofluanid (Hoang et al. 2010). But those additives have short-term effect on the fungus prevention and also chemicals are not safe for human health and the environment.

Chemical treatment is not a safe, sustainable and environmentally friendly method to control fungus and moss growth on walling materials; because the use of the chemicals in the chemical treatments is toxic to the environment and to humans. Chemicals like zinc chloride, zinc sulphate and copper naphthenate are toxic and runoff of the chemicals can results damages to plants, animals and physical structures. Ammonium sulphate is a toxic chemical and also damage to the walling material by corrosion (Ramsay 2003). Application of chemicals and antifungal additives inside the buildings reduces indoor air quality while adversely affect on occupants' health and reduce occupant comfort in the building (Rogawansamy et al. 2015, Kumar & Verma 2010, Zabka et al. 2014).

Fungus and moss growth control using chemical additives is not a sustainable and safe prevention method (Safiuddin 2017). Therefore the sustainable solution is required to prevent fungus and moss growth in the indoor environment of buildings. This study is conducted to study intrinsic properties; such as organic matter content, surface roughness, pH value and water absorption, of walling materials; such as bricks, cement blocks, cement stabilized earth blocks, cabook blocks, mud concrete blocks and geo-polymerized earth blocks, and wall plasters; such as cement slurry plaster and rough cement plaster, and to identify significant intrinsic properties on fungus and moss growth in order to find a sustainable solution to fungus and moss growth to create occupant comfort in buildings.

2. Research Methodology

2.1. MATERIAL SELECTION

Bricks, cement blocks and cabook blocks were selected as the most common walling materials used in the tropical region. And also the novel green walling materials as cement stabilized earth blocks, mud concrete blocks and geo-polymerized earth blocks were selected as test materials. To complete the study the most common wall finishers such as rough cement plaster and cement plaster also included to the material list of the study.

2.2. TESTING INTRINSIC PROPERTIES OF WALLING MATERIALS

2.2.1. Organic matter content

Organic matter content is the fraction of the material that consists of plant or animal tissue in various stages of decomposition. organic matter content provides required nutrients for the bioreceptivity while increasing the water holding capacity of the walling materials (McCauley *et al.* 2017).

Organic matter content of walling materials was tested according to ASTM D2974-00 standards (Udawattha *et al.* 2018, ASTM International 2000). Powdered walling materials were oven dried at 100°C for 24 hours and then burnt in a muffle furnace at 440°C for 48 hours (Figure 1). Organic matter content was calculated according to ASTM standard using measured weight values of samples.



Figure 1, Testing of organic matter content

2.2.2. Surface roughness

Surface roughness of the material is directly effect on the bioreceptivity of the material; because surface roughness effects on the water absorption surface area and the wetted surface area of the material (Cuzman & Tiano 2011). Surface roughness values of walling materials were tested by 3D scanning the material surface (Udawattha *et al.* 2018).

2.2.3. Water absorption

Water is the main requirement for living organisms for their metabolic activities. Walling materials absorb water when they are immersed in water or subject to a high relative humidity environmental condition and wetted walling materials increase the material bioreceptivity (Hoang *et al.* 2010, Karagiannis *et al.* 2016).

Water absorption was tested according to ASTM C272/C272M – 12 test standards (ASTM International 2012). Walling material samples were oven dried at 100°C for 24 hours and the weight, length, height and width were measured. And the samples were horizontally immersed in water for 24 hours and the weight was measured (Figure 3). Then water absorption of each material was calculated (Udawattha *et al.* 2018).



Figure 3, Water absorption test

2.2.4. pH value

pH value is determined by the concentration of the available hydrogen ions (H^+). pH value is measured on a negative logarithmic scale of hydrogen ion concentration (Grubb *et al.* 2007). Biological growth on walling materials is sensitive to the acidity, alkalinity or neutral condition of the material. Fungus and moss species vary with the pH value; because some species prefer acidic conditions and some prefer alkaline conditions while rest of others prefers neutral conditions (McCauley *et al.* 2017; Grubb *et al.* 2007).

pH values were measured according to ASTM D4972-95a test standards (ASTM International 2007). Powdered walling materials were dissolved in distilled water in the ratio of 1:2 and mixed for 30 minutes in a shaker. After 1 hour pH values were measured using a pH meter (Figure 4) (Udawattha *et al.* 2018).



Figure 4, Measuring pH value

2.3. MOSS GROWTH TEST

2.3.1. Sample construction

Mud concrete blocks (Arooz & Halwatura 2018) and geo-polymerized earth blocks (Udawattha & Halwatura 2018) were cast and other materials were collected from the market. Concrete beam with 25cm height was constructed as the base and painted a bituminous paint on the top to prevent moisture absorption from the ground. 1m x 1m walls of each walling material were constructed on the beam with a small roof to prevent rainwater accumulation on walls (Bui *et al.* 2009). Two brick walls were plastered with rough cement plaster and cement slurry plaster.

2.3.2. Application of moss culture media and evaluation

Moss culture media was prepared by blending Existing moss, buttermilk and water in the ratio of 1:2:2. The mixture was painted on wall samples with a paint brush. Moss covered area of each wall was measured weekly and the color change due to the moss growth was compared using photos (Udawattha et al. 2018).

2.4. FUNGUS GROWTH TEST

2.4.1. Sample construction

Fungus test was conducted according to the ASTM D3273-94 test standards. Walling material samples were constructed with the size of 150mm x 100mm x 7mm (Udawattha et al. 2018).

2.4.2. Fungus culture preparation

Potato dextrose agar media was used as the growth media for the fungus culture. Fungus spores were transferred to the sterilized growth media using an inoculating loop. The growth media containing petri dish was incubated for 7 days.

2.4.3. Environmental chamber preparation

Glass environmental chamber was filled 1 inch from the bottom using fungus growth media which was prepared by mixing topsoil, compost and coir dust. Then the media was wetted and the chamber was incubated for 24 hrs. After that, the prepared fungus culture was transferred to the growth media in the environmental chamber and incubated for 14 days. After 14 days test specimens were vertically hanged in the chamber (Figure 5). Fungus growth on each sample was observed weekly and rated the fungus growth area according to the ASTM D3273-94 standards (Table 1).



Figure 5, Samples testing in the environmental chamber

Table 1, Fungus growth rating criteria

Rating	Fungus covered area
0	No fungus growth
1	0 – 10 %
2	11 – 30 %
3	31 – 60 %
4	61 – 100 %

3. Results and Discussion

Intrinsic properties such as organic matter content, surface roughness, water absorption and pH value of each walling material variation shown in Figure 6. According to the statistical analysis of the results, there is a positive correlation between surface roughness value and fungus and moss growth of each material (Figure 7).

According to the color variation comparison of walling materials due to moss growth results show that moss growth increase with surface roughness value of the material (Figure 8). And also the results

showed that no moss growth appeared on cement slurry plaster and rough cement plaster and fungus growth are lowest on plasters.

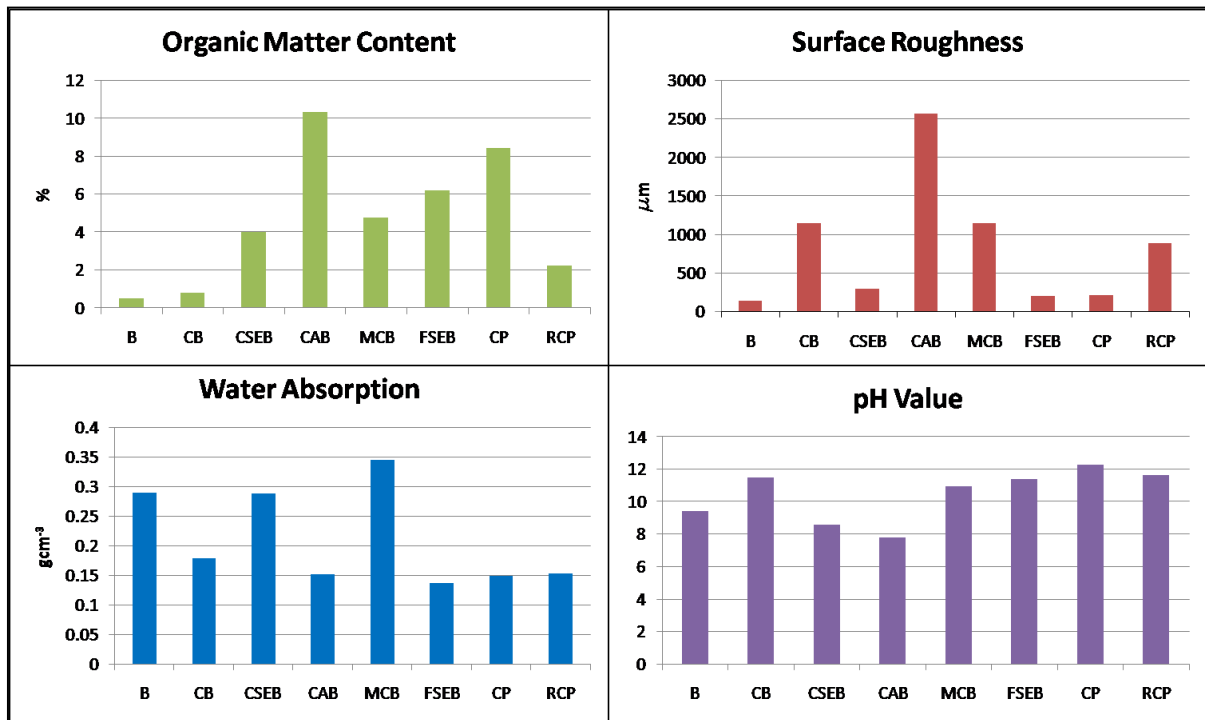

Figure 6, Intrinsic properties variation

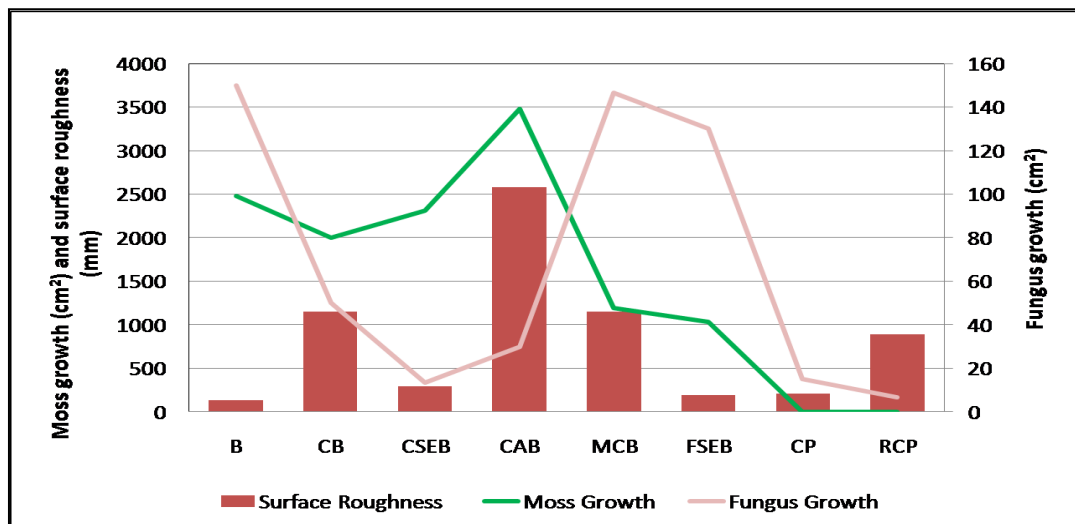

Figure 7, Fungus and moss growth variation with surface roughness

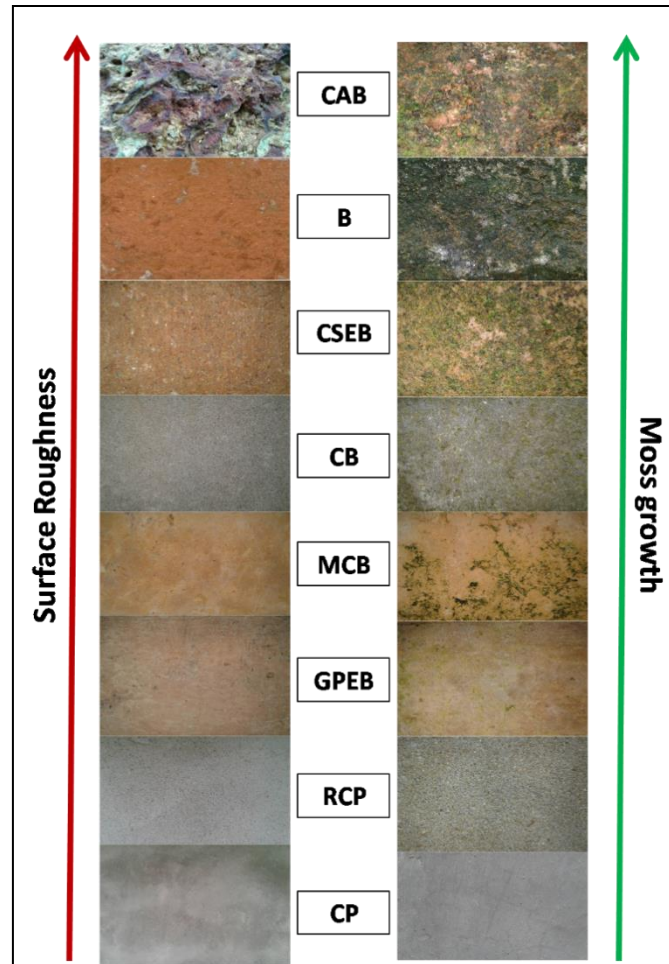

Figure 8, Moss growth variation with surface roughness

4. Conclusion

Fungus and moss grow on walling materials in tropical climatic conditions but wall plastering can protect walling materials from fungus and moss growth. Fungus and moss growth increase with the increase of surface roughness value of walling materials. Covering walls with plaster can reduce the growth of moss and fungus on tropical homes. Therefore smooth, plastered surfaces are best for homes with occupant comfort. But the cost of plastering might prevent poor families from acting on this concept. In the present, the most common wall smoothing and finishing material is cement plaster. But it cannot be recommended as a sustainable solution due to the adverse environmental impacts of cement production. Therefore it is necessary to develop sustainable, cost effective and environmentally friendly wall, smoothing materials and techniques.

5. Acknowledgement

This material is based on work supported by the NSF (National Science Foundation – Ministry of Science, Technology and Research) grant number No: RG/2017/EA&ICT/02. Any options, findings and conclusions or recommendation expressed in this material are those of the authors.

6. References

- Arooz, F.R. & Halwatura, R.U., 2018. Mud-concrete block (MCB): mix design & durability characteristics. *Case Studies in Construction Materials*, 8(December 2017), pp.39–50. Available at: <https://doi.org/10.1016/j.cscm.2017.12.004>.
- ASTM International, 2012. *ASTM C272/C272M-12, Standard Test Method for Water Absorption of Core Materials for Sandwich*, West Conshohocken. Available at: www.astm.org.
- ASTM International, 2000. *ASTM D2974 - 00, Standard Test Methods for Moisture, Ash, and Organic Matter of Peat and Other Organic Soils*, West Conshohocken. Available at: www.astm.org.
- ASTM International, 2007. *ASTM D 4972-95a, Standard Test Method for pH of Soils*, pp.1–3. Available at: www.astm.org.
- Baxi, S.N. et al., 2016. Exposure and Health Effects of Fungi on Humans. *Journal of Allergy and Clinical Immunology: In*

Practice, 4(3), pp.396–404.

- Bui, Q.B. et al., 2009. Durability of rammed earth walls exposed for 20 years to natural weathering. *Building and Environment*, 44(5), pp.912–919. Available at: <http://dx.doi.org/10.1016/j.buildenv.2008.07.001>.
- Cuzman, O.A. & Tian, P., 2011. Biodiversity on Stone Artifacts. *The Importance of Biological Interactions in the Study of Biodiversity*, pp.367–390.
- Degrave-Lemeurs, M., Glé, P. & Hellouin de Menibus, A., 2018. Acoustical properties of hemp concretes for buildings thermal insulation: Application to clay and lime binders. *Construction and Building Materials*, 160(December 2017), pp.462–474.
- Dylag, M., 2017. Fungi present in home and their impact on human health-A short review. *Insights in Biology and Medicine*, 1, pp.16–25.
- Gray, M.P., 2010. *Cave Art and the Evolution of the Human Mind*. Victoria University of Wellington.
- Grubb, J.A., Limaye, H.S. & Kakade, A.M., 2007. Testing pH of Concrete. *Concrete international*, 29(4), pp.78–83.
- Haleem Khan, A.A. & Mohan Karuppaiyil, S., 2012. Fungal pollution of indoor environments and its management. *Saudi Journal of Biological Sciences*, 19(4), pp.405–426. Available at: <http://dx.doi.org/10.1016/j.sjbs.2012.06.002>.
- Hoang, C.P. et al., 2010. International Biodeterioration & Biodegradation Resistance of green building materials to fungal growth. *International Biodeterioration & Biodegradation*, 64(2), pp.104–113. Available at: <http://dx.doi.org/10.1016/j.ibiod.2009.11.001>.
- Al horr, Y. et al., 2016. Impact of indoor environmental quality on occupant well-being and comfort: A review of the literature. *International Journal of Sustainable Built Environment*, 5(1), pp.1–11. Available at: <http://dx.doi.org/10.1016/j.ijbsbe.2016.03.006>.
- Ismail, S.H., Deros, B. & Leman, A.M., 2010. INDOOR AIR QUALITY ISSUES FOR NON-INDUSTRIAL WORK PLACE. *IJRRAS*, 5(December), pp.235–244.
- Karagiannis, N. et al., 2016. Building Materials Capillary Rise Coefficient : Concepts, Determination and Parameters Involved. In J. Delgoda, ed. *New Approaches to Building Pathology and Durability*. Singapore: Springer, pp. 27–44. Available at: https://doi.org/10.1007/978-981-10-0648-7_2.
- Kumar, M. & Verma, R.K., 2010. Fungi diversity, their effects on building materials, occupants and control - A brief review. *Journal of Scientific and Industrial Research*, 69(9), pp.657–661.
- McCauley, A., Jones, C. & Olson-Rutz, K., 2017. Organic Matter. *Nutrient Management*, 4449(8), pp.1–16.
- Moya, T.A. et al., 2018. A review of green systems within the indoor environment. *Indoor and Built Environment*, 0(0), pp.1–12.
- Mycol, C.M. et al., 2016. Aspergillus species in indoor environments and their possible occupational and public health hazards. , 2(1), pp.36–42.
- Ozolins, A. & Jakovics, A., 2014. Risks of mould growth in different building structures. In *International Conference „Innovative Materials, Structures and Technologies*.
- Pranjic, A.M. et al., 2015. The bioreceptivity of building stone. *Geophysical Research Abstracts*, 17.
- Ramsay, C.A., 2003. *STRUCTURAL & TURF DEMOSSING* C. A. Ramsay & G. L. Thomasson, eds., Washington: Washington State University Extension. Available at: <http://pubs.wsu.edu>.
- Rogawansamy, S. et al., 2015. An evaluation of antifungal agents for the treatment of fungal contamination in indoor air environments. *International Journal of Environmental Research and Public Health*, 12(6), pp.6319–6332.
- Safiuddin, M., 2017. Concrete Damage in Field Conditions and Protective Sealer and Coating Systems. *Coatings*, 7(90), pp.1–22. Available at: www.mdpi.com/journal/coatings.
- Singh, M., Vinodh Kumar, S. & Waghmare, S., 2016. Mud Plaster Wall Paintings of Bhaja Caves: Composition and Performance Characteristics. *Indian Journal of History of Science*, 51(3), pp.431–442. Available at: http://insa.nic.in/writereaddata/UploadedFiles/IJHS/Vol51_2016_3_Arto1.pdf.
- Udawattha, C. et al., 2018. Mold growth and moss growth on tropical walls. *Building and Environment*, 137(January), pp.268–279. Available at: <https://doi.org/10.1016/j.buildenv.2018.04.018>.
- Udawattha, C. & Halwatura, R., 2018. Geopolymerized self-compacting mud concrete masonry units. *Case Studies in Construction Materials*, 9, p.e00177. Available at: <https://doi.org/10.1016/j.cscm.2018.e00177>.
- Udawattha, C. & Halwatura, R., 2016. Thermal performance and structural cooling analysis of brick, cement block, and mud concrete block. *Advances in Building Energy Research*, 126(0), pp.28–35.
- Zabka, M., Pavela, R. & Prokinova, E., 2014. Antifungal activity and chemical composition of twenty essential oils against significant indoor and outdoor toxigenic and aeroallergenic fungi. *Chemosphere*, 112, pp.443–448. Available at: <http://dx.doi.org/10.1016/j.chemosphere.2014.05.014>.
- Żukiewicz-Sobczak, W. et al., 2015. Health Risks Associated with Exposure to Fungi. *Agriculture and Agricultural Science Procedia*, 7, pp.313–317. Available at: <http://linkinghub.elsevier.com/retrieve/pii/S2210784315300541>.

Samarawickrama, Sumanthri, et al (eds), 2018, "Sustainability for people - envisaging multi disciplinary solution": *Proceedings of the 11th International Conference of Faculty of Architecture Research Unit (FARU), University of Moratuwa, Sri Lanka, December 08, 2018* Galle pp. 74-79. ©

UNDERSTANDING CHARACTERISTICS OF PEDESTRIANS AND DESIGN PATH

PHUNTSOK. CHHIME DOLKAR¹ & RATNAYAKE. RANGAJEEWA²

^{1,2}University of Moratuwa, Colombo, Sri Lanka

¹dolkarphuntsok@gmail.com, ²rangajeewar@gmail.com

Abstract

Walking, aside from mobility is also recognized as a means to stay physically fit while increasing social interaction, promoting community wellbeing and reducing stress on the environment. This has thus led to a growing area of study focused on the role of the physical environment in promoting the activity of walking. However, not many researches are done with reference to micro environmental features. There is even fewer evidence which suggests that associations between walkability and walking may vary according to different ages. This study argues that walking can be influenced by micro environmental features but preference for environmental features are likely to differ across different age and gender groups. Data on the preference were collected through questionnaire survey from three different age group with the use of manipulated models of pedestrian path. Descriptive and inferential statistics were used for analysis. Amongst the 21 micro environmental variables derived, the preference of 'engaging nature', 'colourful signs' and 'wall painting', decrease when age increases whereas 'water faucets', 'presence of people' and 'surface condition of the footpath', increases with age. Features such as 'wide path', 'separation of traffic' and 'vegetation' were preferred mostly by Children and Elderly. The findings of this study help understand how micro environmental factors can influence user perceptions of quality, this will further help planners, architect and health workers to understand pedestrian's preference and design paths that not only influence walking in all age groups but also be enjoyed by all.

Keywords: Age groups, environmental psychology, pedestrian, preference, walkability.

1. Introduction

Walking is the most basic and prevalent mode of transport and it has been a necessary means of mobility since the start of human history. Today walking is not only considered as a means of mobility but it is also recognized as a means to stay physically fit, strive for sustainability and reduce stress on the environment. According to modern dictionary a person walking is termed as a pedestrian. Pedestrians form the largest single road-user group. With rapid urbanization and motorization most of transportation planning is centered around vehicle and its space requirements. When the planning process gives priority to the car, the product may seem devoid of human scale. As a result, those moving around the city on foot or on a bicycle may find urban spaces monotonous, with long straight lines and corresponding buildings (Andersen, 2009). Walking compared to the heavy use of private vehicles, have multiple benefits of reducing traffic congestion, air pollution, and fuel consumption while increasing physical activity, social interaction, and community safety and well-being.

Walking and environmental features can also be linked to active living and public health. Researches such as those done by (Day, Boarnet, & Alf, 2006) suggests an intriguing link between public health and urban planning that supports active living. The role of the physical environment in promoting or limiting physical activity is a growing area of study. This have resulted in many researches on the built environment and physical activity being fragmented across several fields, including urban planning, architecture, environmental psychology, recreation/leisure studies, and public health (Day, Boarnet, & Alf, 2006).

The activity of walking is influenced by many different factors. This research will focus on two: by pedestrian characteristics and the built environment. The connection between them will be done through environmental psychology while looking through different psychological characteristics in the different age groups. The overall study it forms through this aspect will bring new perspective as such researches are not very common. Understanding the needs and characteristics of pedestrians and

factors that affect pedestrian travel is important when designing pedestrian facilities. When the likes, preferences and peculiarities of the users, created under the influence of the user's developmental psychology are taken into consideration, designed spaces will be enjoyed more often by the most users (Ozer & Baris, 2012).

This research will answer whether different age groups have different preference when it comes to micro environmental factors of pedestrian path, whether the preference change with gender and whether we can have a generalize pedestrian model that fits all age groups. The research was done in three level: -literature review, preparation of sample preference models, field survey and analysis. Micro environmental factors that influence walking in different age groups was compiled through literature review. Based on it three models preferred by each age group and a model that is for all was made using 3-D computer software. All four models were based off on Bandaranayake road, connecting university of Moratuwa and Katubedda Junction. The models prepared were then used in questionnaire survey to collect data. The data gathered was analyzed using descriptive and inferential statistical analysis.

2. Theoretical background

'Pedestrian' includes all non-vehicular mobility including those who use wheelchairs, guide dogs or other mobility aids. Pedestrian can be characterized based on factors such as ability and age. Walking can be influenced by the character of the pedestrian as well as the perceived and objectively determined environmental attribute (Humpel, Owen, & Leslie, 2002). The environmental attribute can fall into two broad categories: macroscale, consisting of structural features such as street inter-connectivity and land use mix; and microscale or details that can affect the experience of being active in a place, such as aesthetics and sidewalk design. A research done by (Ratnayake, Silva, & Warusavitharana, 2017) discusses that environmental cues such as indivisibility of road segment, physical upkeep, presence of people, distribution of households' effects on pedestrian feeling of safety.

Another research done by (Cain et al., 2014) examines associations of microscale attributes with multiple physical activity measured across four age groups. The research supports the ecological model principle of behavioral specificity. Age-related changes in experience and behavior can be supported by developmental psychology. Piaget and Erik Erickson view of development psychology provide an account of development throughout the life span. On the other hand, environmental psychology is the study of transactions between individuals and their physical settings. In these transactions, behavior and experiences are changed by their environments depending on their developmental age. This relationship can ultimately improve human environments, by devising practical methods, design and planning that are receptive to the findings of environmental psychology (Zube & Moore, 1987).

3. Methodology

3.1. CASE STUDY AREA

The case study area is based on Bandaranayake road, connecting the University of Moratuwa and Katubedda Junction. The existing road is 1.4 km long starting from the university to Katubedda Junction and it lacks a proper continues pedestrian path. Theoretically, it will take a minimum of 15 mins to walk, but most students prefer to ride the bus instead. The path also contains environmental characteristics that vary as we walk. The study area was also chosen based on its convenience and familiarity.

3.2. MODEL MAKING

The four 3D models of Bandarayanake road were made to assess preference of pathway by different age groups. Each model has a set of micro environmental features that are fitted for each age group derived based on previous researches. One extra model containing elements that are supposed to be fit for all age groups were also made resulting in a total of four models. The model was made using Revit, Sketchup and AutoCAD software. Model for the elderly contain the following micro environment features: sidewalk evenness, separation from traffic, an obstacle on the sidewalk, traffic volume, speed limit, traffic calming device, overall upkeep, vegetation, benches, one vehicle.

Model for adults contain the following micro environment features: artistry and attractiveness of the shops and store windows, bicycle lane, shade, cleanliness and upkeep, the presence of people, few

vehicles. The model for children focusses contain the following micro environment features: engaging nature, colourful signs, wide path, aboriginal artwork, fun places to rest, sculptural elements, and playability of street. Lastly, model for all age groups contain the following micro environment features: attractive architecture, comfort features (shade trees, benches), more pedestrian crossings, water faucets and local cafés/shops.



Figure 11 Model for elderly



Figure 12 Model for adults



Figure 13 Model for children



Figure 14 Model for all

3.3. DATA ANALYSIS

Data collected through questionnaire survey was analyzed through descriptive and inferential statistics such as the use of correlation and regression analysis and graphical analysis. Descriptive characteristics of the samples were calculated using software IBM SPSS statistics 23. Cross-tabulation and chi-square analysis were used to look for a relationship between age group and their preference of micro environmental features as both variables fall under categorical data. Further to assess the validity of the analysis p-value was referred. Further correlation analysis was done for variables which appeared significant.

4. Results

From the questionnaire survey, 43.6% of the samples were collected from nearby schools, 21% of samples were collected from the university and rest 35.4% were collected from the Bandaranayake street. Among them 120 participants belonged to age group of children (less than 18), 110 participants belonged to the age group of adults (19-59), and 45 belonged to an elderly group (60 and above). As for the gender distribution, 155 identified themselves as male and 120 identified themselves as female. Table 7 till 18 in annexe presents the socio demographic characteristics, physical function, social support and participant's use of the pedestrian path of the sample.

From the responses received regarding the obstruction faced while walking in their day to day life, bad weather (sun and rain) accounted for 32% of the response, safety accounted for 24.4% and no proper facilities accounted for 11.6%. When asked about Bandaranayake road specifically, 7.81% of the responses were positive responses. The rest 92% of responses were negative concerning walkability. When computing micro environmental features in the total sample 'pedestrian path separated from traffic' was the most preferred feature with a score of 492 with 550 being the maximum possible score

for all feature. It was followed by 'less traffic volume' (460), 'cleanliness and upkeep' (449), for which there was not much difference in score. The features that scored the lowest were 'Sculptural elements' (157), and 'Presence of street vendors' (153).

Amongst the micro environmental variable, chi-square shows that few features show significant relationships ($p=0.000$) with age groups. The preference of variable 'engaging nature', 'colourful signs', 'wall painting', 'fun places to rest' and 'sculptural elements' have weak negative correlation of $r = -0.455$, -0.246 , -0.290 , -0.400 , and -0.172 , respectively this tells us that their preference decreases when age increases. 'Attractive architecture' has the weakest negative correlation (-0.074). On the other hand, 'playability of street' and 'bicycle lane', has a strong negative correlation of $r = -0.501$, -0.503 respectively. 'Water faucets' has a weak positive correlation of $r = 0.070$. As for 'presence of people' and 'surface condition of the footpath', they have a strong positive correlation of $r = 0.536$, and 0.557 respectively. A positive correlation means its preference increases with age. Variable such as 'Wide path', 'separation of traffic' and 'vegetation' are a special case as their relationship direction is quadratic its preference increases in children, decreases in adult and increases again in elderly.

The analysis of age group against the 3-D model of four streets overall resulted in 49.6% of participants choosing model B as their first preference, 30.3% of participants choosing model C as their second preference, 29.6% of participants choosing model A as their third preference and 41.6% of participants choosing model D as their least preference. This tells us that the order of B-C-A-D is the most common order of preference. Most preferred B dues to reasons such as separation of path from the road, aesthetically pleasing, wall paintings, statue, comfortable, trees for shade and benches for seating, and foot prints.

The environmental feature computed against age groups shows that all age group ranks 'safety' (69.1%) as the most important followed by 'accessibility' (36.0%), 'comfort' (36.3%) and 'pleasurability' (52.0%). Therefore, the order of preference for the majority of the participants is 'safety – accessibility – comfort – pleasurability'. When computing variable 'gender' against 'micro environmental' preference resulted in 15 out of 21 parameters of micro environment having no relationship with gender. Features like 'engaging nature', 'wall paintings', sculptural elements, 'water faucets' and 'local cafes and shops' were found to be given more importance by male than females. Whereas, features such as 'fun places to rest' were more inclined towards females. However, p-value with of 0.082 model preference didn't change with gender.

5. Discussion

Currently, there is a lack of research conducted that study the associations between walkability and physical activity according to different life-stages. The current study and its methodology aim to examine the preference of micro environmental features in the pedestrian path by different age groups, and their reasoning can be explained based on environmental psychology. This can serve as useful inputs for urban planning in understanding and designing pedestrian path as planning is done for the betterment of people. Further, as the case study is Bandaranayake road which lacks a proper pedestrian path, the findings of this study can be used by authorities to provide one that can be enjoyed by all.

Amongst the micro environmental derived variables, the preference of 'engaging nature', 'colourful signs', 'wall painting', 'fun places to rest', 'playability of street', 'bicycle lane' and 'sculptural elements' decreases when age increases. They are mostly liked by children and these findings can be referred back to developmental psychology. Theory such as that of Piaget's theory of intellectual development states that active discovery learning environments are essential to enable children to explore, manipulate, experiment, question and to search answers for themselves. Objects of such shade are stimulating and interesting.

A study conducted by Wansink and Kevin Kniffin and Mitsuru Shimizu of London Metropolitan University also found that kids prefer lots of choices and colours. Micro environmental variables mentioned as such provide a source of stimulus to explore, learn and enjoy for children. For example, 'colourful signs', 'wall painting', and 'sculptural elements' provide stimulus for cognitive development,

'fun places to rest' and 'playability of street' provide for the social development and 'playability of street' and 'bicycle lane' provide for physical development.

Preference of micro environmental such as 'water faucets', 'presence of people' and 'surface condition of the footpath', increases with age. They are mostly preferred by those belonging in elderly age group. A variable such as 'presence of people' can be related to the perception of safety and 'surface condition of the footpath' to physical fitness this may be because elderly are physically frailer and have difficulty in recovering (Skogan, 1978). 'Water faucets' may be due to the fact that when people get older, body water content decreases and the risk of dehydration increases. This can also be connected to their higher rate of chronic illness which makes it difficult for the body to balance and manage body fluid (Ratnayake & Butt, 2018; Frangeskou, et al., 2015; Ranasinghe et al., 2016).

Variable such as 'Wide path', 'separation of traffic' and 'vegetation' are preferred more by Children and Elderly. The preference of 'wide path' and 'separation of traffic' are also related to safety and can be due to the fact the participants in these groups are the most functionally limited and more likely to use walking aids. Safety was also ranked the most by both children and elderly among the environmental feature. The four 3-D models made use various combination of the derived micro environmental features. From all the age groups majority like model B, which was designed to appeal towards the age group of children. The common reasons given for their preference was that model B looks, is aesthetically pleasing and it looks comfortable. Choosing model B can also be due to people not liking monotony psychologically as stated in (Anderson, 2009).

6. Conclusion

In conclusion, the findings of this study can be used to make potential modifications to real life settings regarding which micro environmental features to be prioritized. It can be used to design an environment with conditions that can not only provoke walking but also ensure safety and enjoyment. While this may be true there are also certain limitations, first of all, the study was conducted within a small range of area with a limited number of people and time, and therefore, the data collected was limited. Second, though three age groups were taken, the ages of the participant within each group is skewed. Third, since 3-D models were used there is a need for natural experiments to confirm the findings. The results may thus differ in different places and people. Future research may be carried out with a larger sample, consideration of both day and night can be explored and different socio-economic variables such as income and ethnicity can be reflected.

References

- Abley, S. & Turner, S, 2011. Predicting Walkability: Technical Report".. s.l.:New Zealand Transport Agency.
- Aghostin-Sangar, V, 2007. Human behaviour in public spaces, Sydney: University of New South Wales.
- Anbari, M. & Soltanzadeh, H, 2015. Child-oriented architecture from the perspective of environmental psychology. *European Online Journal of Natural and Social Sciences*, pp.137-144.
- Anderson, B, 2009. *Emotion, Space and Society*. Elsevier, pp. 77-81.
- Butt, A., Ratnayake, R., & Budge, T, 2016. Planning education and inter-cultural collaboration: awareness, innovation, reflection and preparation for practice. *Bhumi, The Planning Research Journal*, 3(1).
- Cain, K. L. et al, 2014. Contribution of streetscape audits to explanation of physical activity in four age groups based on the Microscale Audit of Pedestrian Streetscapes (MAPS). *Elsvier*, pp. 82-92.
- Cervero, R. & Kockelman, K, 1997. Travel Demand and the 3Ds: Density, Diversity and Design. *Transport and Environment*, pp. 199-219.
- Day, K., Boarnet, M. & Alf, M, 2006. The Irvine–Minnesota Inventory to Measure built environment. *American Journal of Preventive Medicine*, pp. 144-152.
- De Silva, C. S., Warusavitharana, E. J., & Ratnayake, R, 2017. An examination of the temporal effects of environmental cues on pedestrians' feelings of safety. *Computers, Environment and Urban Systems*, 64, 266-274.
- Forsyth, A. & Southworth, M, 2008. Cities Afoot—Pedestrians, Walkability and Urban Design. *Journal of Urban Design*, Vol 13, pp. 1-3.
- Frangeskou, M, Lopez-Valcarcel, G. B. & Serra-Majem, L, 2015. Dehydration in elderly: a review focused on economic burden. *The journal of nutrition, health and aging*(19)6, pp.1-9.
- Humpel, Owen, N. & Leslie, E, 2002. Environmental factors associated with adults' participation in physical activity: a review. *American journal of preventive medicine*, pp. 188-199.
- H-w, W. & Frieder R, L, 2003. Aging in cotext across the adult life course: integreting physical and social environmental research perspective. *Annual review of gerontology and geriatrics*, pp. 1-33.

- Ozer, B. & Baris, E. M, 2012. Landscape design and park users' preferences. Elsevier. *Procedia - Social and Behavioral Sciences*, p. 604 – 607.
- Ratnayake, R, 2017. Sense of safety in public spaces: university student safety experiences in an Australian regional city. *Rural Society*, 26(1), 69-84.
- Ratnayake, R, 2013. Environmental features and sense of safety. *WIT Transactions on Ecology and the Environment*, 179, 377-388
- Ratnayake, R., & Butt, A. (2018). Encounters with the unfamiliar: international planning education. *International Planning Studies*, 23(1), 51-64.
- Ratnayake, R, 2016. Fear of crime in urban settings: influence of environmental features, presence of people and social variables. *Bhumi, The Planning Research Journal*, 3(2).
- Ranasinghe, G., Amarawickrama, S., & Rathnayake, R, 2016. A Study to Compare the Level of Walkability in Two Urban Neighborhoods of Sri Lanka. *International Journal of Engineering Research and General Science*, 4(1), 6-13.
- Skogan, W., 1978. *The fear of crime among elderly*, Evanston: Northwestern university.
- Wasfi, R., Steinmetz-Wood, M. & Kestens, Y, 2017. Place matters: A longitudinal analysis. PLOS ONE.
- Zube, E. & Moore, G. T, 1987. *Advances in environment, Behaviour and design*, Volume 1. New York: Plenum press.

Samarawickrama, Sumanthri, et al (eds), 2018, "Sustainability for people - envisaging multi disciplinary solution": *Proceedings of the 11th International Conference of Faculty of Architecture Research Unit (FARU), University of Moratuwa, Sri Lanka, December 08, 2018* Galle pp. 80–90. ©

A STUDY OF URBAN NEIGHBOURHOOD OPEN SPACES AND THEIR PROPENSITY TO ENCOURAGE CRIME WITH REFERENCE TO KOTAHENA.

AISHAN RANASINGHE¹ & GAMINI WEERASINGHE²

^{1,2}Department of Architecture, university of Moratuwa, Sri Lanka

¹aishanlahiru@gmail.com, ²gamini.weerasinghe@gmail.com

Abstract

As a country which is on its developing process, it is not enough to play their role as they were programmed. People should have better opportunities and time to deploy their ideas for a better tomorrow. Sri Lankan city spaces, which had already been planned, face many difficulties because of haphazard development and Urban sprawl effect. The lack of understanding of the urban context has caused numerous issues, with crime being one of them. There are various key factors which identify society and crimes, some of which allow understanding of the nature of spaces in principles. The method applied in this research is based on three steps. The UCL DepthmapX is used to simulate the integration of the spaces in a selected area of study, followed by CPTEDP (crime prevention through environment design principles) and urban design principles being applied in these specific spaces where the simulation was conducted. Finally, a correlation was established with daily crime patterns and the above qualitative and quantitative analysis of the spaces. The final results indicated correlation between environment and crime. The pedestrian traffic/movement and social network have a direct connection with crime pattern. In this case only robberies, devastations and housebreaks are considered. Kotahena was selected as the case study; which almost has the same social characteristics within its urban space. The objective of the research is to find out how the city space and its neighbourhoods' respond to crime incidents. Landscape characters have been chosen to identify the change of the crime patterns with the cityscape. It is expected to come up with recommendations to apply crime prevention principles and urban design principles. The integration patterns of city are aligned with crime events and the landscape attributes. The cognitive movement can be understood by the software and a crime pattern can be formed. The inadequate attribute of space, identified by CPTED principles can be formed to reduce identified crime incidents through designing and a proper planning solution.

Keywords: *Space syntax, Crime patterns, Integration, Spatial configuration.*

1. Introduction

Industrial and economic base contributes towards culture through economic factors, decreasing comfort and social play. In the process the environment gets neglected because there no focus on it. These circumstances create natural chaos for living being and poor quality of the land, leading to the neglect of comfort ability and the space for "living". (Alam, Islam, & Golam, 2008).

The city spaces are built with its background network (driven by society and the culture) and foreground network (the structure formed to maximize the movement). A city is built with centers of foreground network. The most segregated spaces which are built in backyard of urban neighbourhoods have less attention rather than integrated spaces, and the intention to crime is naturally built up in these areas. But those are composed of some attributes of society. The social attributes can vary according to the context, and according to the Burgess Zone model the characteristics of society can vary in between the spaces, which can be identified by analyzing the spread of urban growth.

2. Research Issue and objectives

There are special characteristic of a space which contribute less towards Felony (murders/ well analyzed crimes), but contributes more to Misdemeanor (robbery/ hurts). Crimes such as

misdemeanors happen instantly, when the propensity is developed by the space itself, giving the opportunity for certain types of criminal activities.

The research questions are stated as:

Why criminals choose specific spaces in order to perform crimes? Are people are not aware of such spaces? What is the link between crime and environment? Does the same patterns and attributes cause crime incidents in urban spaces in the Sri Lanka?

The neighbourhood spaces which are oriented with pedestrian movement is considered in this study. While investigating crime, the Police use an approach which relates to the particular space, which will be taken into consideration through this study.

The main objective of the study is to check, how the residential open spaces, with their spatial structure and the route system influence criminal activities on its territory.

2.1 LIMITATIONS OF THE STUDY

The study is focused on both quantitative and qualitative factors which can be considered while understanding the urban landscape and its relationship to criminal activities. Most of the crimes are generated by the nature of the society, a factor that was not taken into consideration... Though this study is focusing on special qualities, different types of urban neighborhoods and deferent layouts have been selected. Further, as mentioned before felony is not considered for this study.

3. Theoretical background and theoretical framework

Previous research done on crime and urban spaces have followed deferent methods, depending on formation of social interactions and unique characters of the area. Most of them have been conducted in spaces designed for that purpose. But the normal urban spaces which have evolved due to backwaters and palimpsest influence should have a different relationships with crime. These causes form the environment which encourage crime and build social harm approach.

CPTED (crime prevention trough environment design) principles also focus on effects and the functionality of the design principles. CPTED was originally formulated by criminologist C. Ray Jeffery. As a more limited approach to crime, defense and neighbourhood, the term “defensible space” was developed concurrently by architect Oscar Newman to understand the social interaction and the designing methods. Natural surveillance, natural access control and territorial behavior is checked in each selected spaces.

Jane Jacobs (1961), in *The Death and Life of Great American Cities*, discusses the intention of crime and the safety issues of an urban context relating with building formations and human behavior “The eye on the street”. Mostly the streets and network of the streets correlating with these issue. (Jacobs, 1961) Elizabeth wood, Crime prevention philosopher (Wood, 1967), believed that crime can be prevented with connectivity and understanding between the residents. According to Defensible space theory, offenders do not have reasons for being in private or semi-private spaces, even restricted public spaces distinguish the spaces between public and private, and it is possible to exert a measure of social control in order to reduce the potential for crime.

The development of space syntax method by University College London by Prof Bill Hillier is an applicable observation to identify the human integrations and the quality of the space. After the space is considered as a quantitative factor, it is easy to understand the use and the function of the space. This methodology is used to clarify the issues built in urban spaces with applying the real data, such as crime incidents and principles.

3.1. CONNECTIVITY OF THE OPEN SPACE

The linkage between street networks and connected open space made at certain streets become more usable. It causes to build a healthy environment between the social and natural elements. (Hillier, 2014) As Hillier explains, the form of the space is created by its buildings or streets that are either linear, convex or concave. It controls the human behavior on a certain space. The density, income of the people, type of activities, usage, comfort, and visual quality can differ from space to space. Space syntax analysis methods corresponds with the properties and factors that control the urban structure and the social behavior on the urban layout.

Draft meaning of the space syntax measures to identify the space as a quantity factor, in analysis

Integration – how people are likely to be in the area

RA (relative asymmetry) **R2** – numerically key aspect of the space.

(0 – high functional, 1 – low functional)

Mean depth R2 – how depth or shallow a space connect to another space

Connectivity – number of neighbourhoods connected to a one space

Choice – movement flow through the space (high – shortest path, low – longest path)

4. Methodology

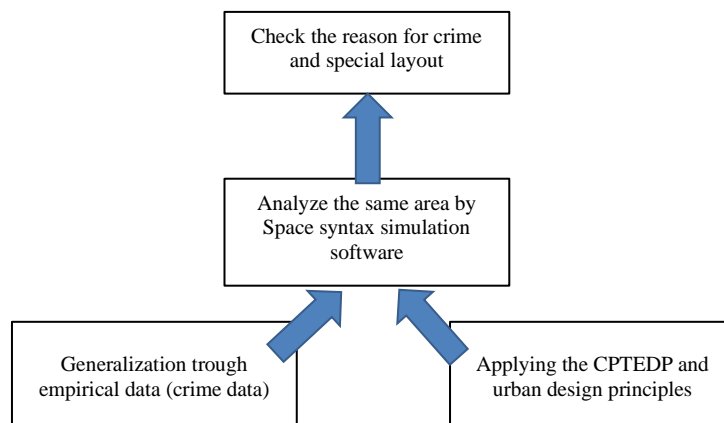

Figure 1, The method of study (Source: Ranasinghe A)

This research has focused mainly on the neighbourhood interaction and their changes and characteristics based on the context. Connection between onsite crime incidents and human integration has a direct link that consideration helps to apply the principles on the case study. The underlying theoretical framework is discussed in the Literature review.

Basically the research is done under 3 sub objectives. Each objective focus on methods which are used to study the research issue. The methodology is as follows.

1. Obtain crime data and crime map from Police department to clarify the crime pattern,
2. Use the space syntax simulation on each spaces to check whether the attributes of the crime events (connectivity, alternative paths, integration, and special definitions) are aligned to the real situation.
3. Finally the CPTED principles and urban design principles are checked in selected areas in Kotahena open space to understand the reasons for the crime issues and form a criterion on selected attributes of the space.

5. Method of case study selection

The case study selecting procedure was done through two stages. The first stage was in selection of the crime potential spots and identify the urban forms of the selected spaces. The data was taken from local police department. Then the Space syntax map was used to check the correlation with empirical data. Kotahena consists of a radial urban form which is based with an integrated street network. The radial pattern of Kotahena causes an increase in human movement in all the spaces. It has both residential and working class zone. Basically every zone is in its transitional period. The neighbourhood spaces act as separate blocks. Kotahena is a multi-cultural as well as a multi-functional area, though there are majority of Tamils, the race diversity is high. This area is a major crime spot in Colombo region. There are various social and economic reasons for those incidents. While investigating the crime spots, it can be discovered that there are specified location for specific crime styles. Though those spaces have the same social and economic background, each individual space has deferent type of attributes. The frequency of the crime events are higher in some of these location.

6. Kotahena as the study context (Case no 1)

As the selected criteria of analysis, the crime map of Kotahena is generated, based on the misdemeanor incidents. Data from 2018 January to 2018 May is presented in the map. According to the crime map, most of the incidents took place in Prickerings RD, Jinthupitiya RD, New Chetti St and Sangamiththa Mt. There have been a high incidence of Devastate in Prickering road and high incidencel of robberies in other areas. The movement pattern is almost the same in both sectors divided by the main road. A clear change of the crime pattern can be identified witin the context of the study area. The incidents which had happened on the generative spaces can be seen in the map.

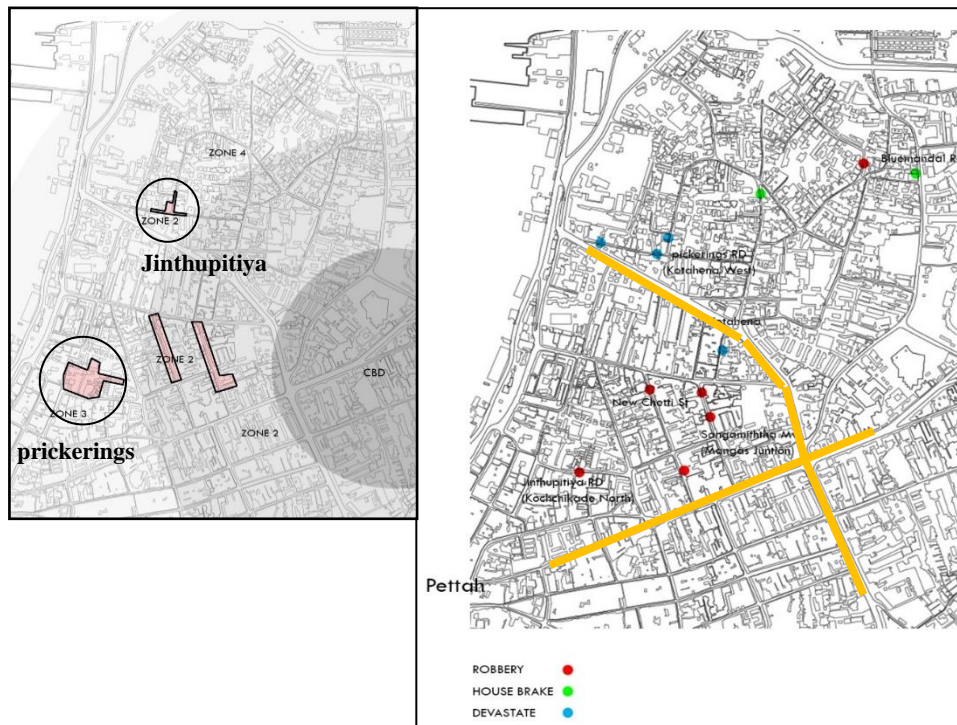

Figure 2, The crime map (Source: Kotahena police department, edited Ranasinghe A)

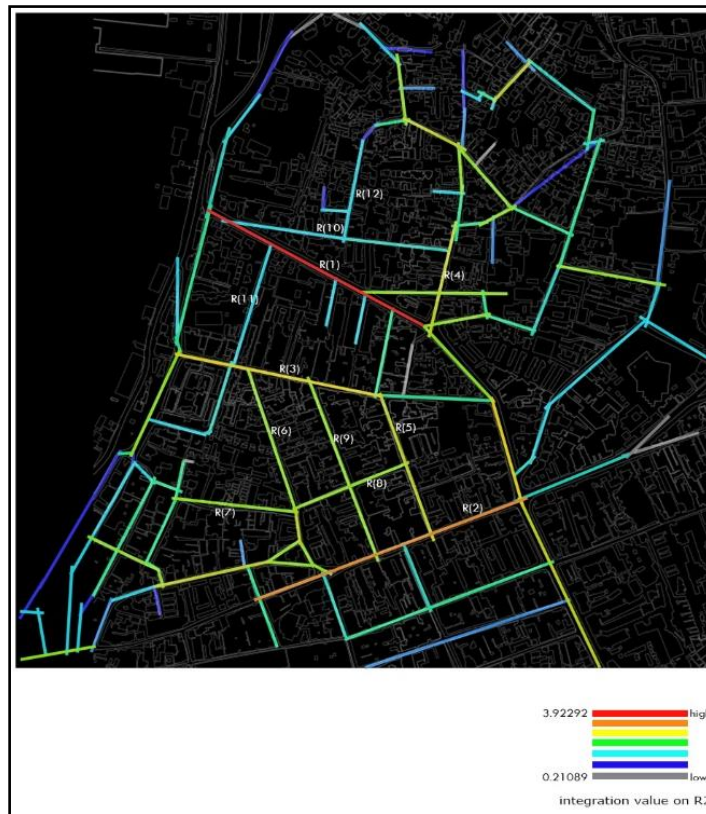

Figure 3, Comparison of urban design principles, data formed by Space syntax.
(Source: Ranasinghe A)

6.1 CASE NO 2 – PRIKERINGS RD

Case study #2 is selected as Prickerings RD. This is located in Zone 2 (according to Burgess Zone model). It consists of both residential spaces and industrial spaces. This has created different characteristic to the neighbourhood. According to the police reports the Devastate incidents had happened around a space in-between residential and industrial area. Prickerings RD located in Kotahena West region. Majority are Tamils. But most of the residential blocks are occupied by Sinhala people. It's connected to Kotahena Street and the main road.

6.1.1 Analysis of the case study – Prickerings RD

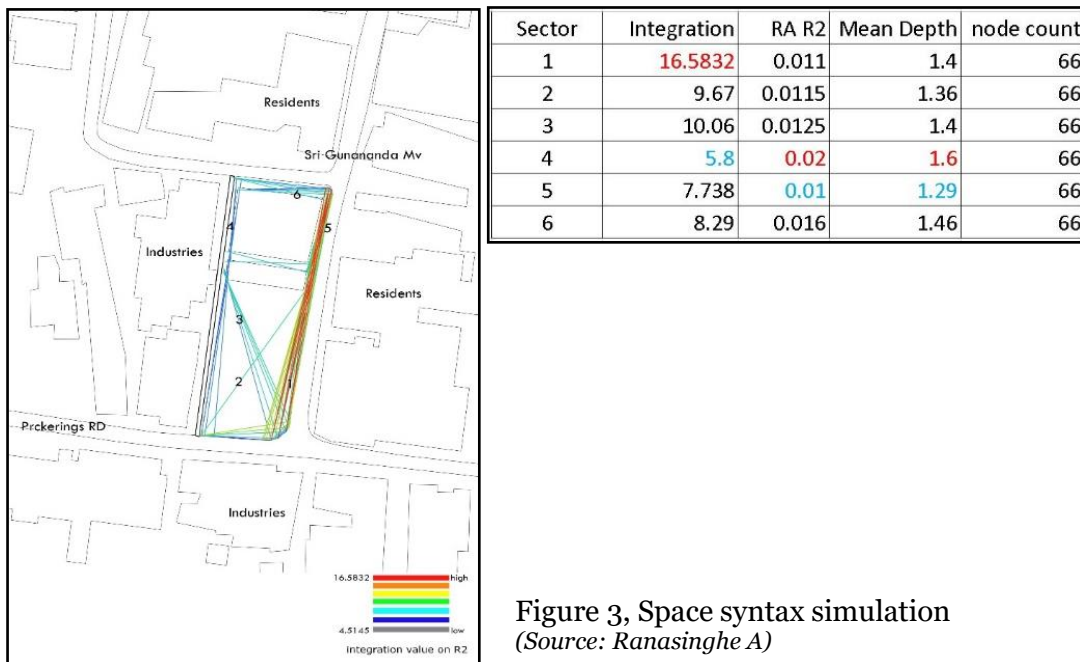
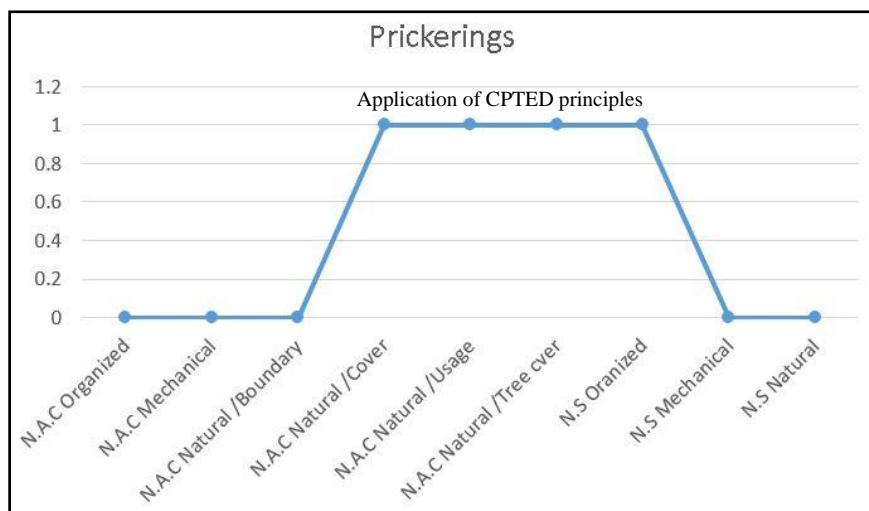

Figure 3, Space syntax simulation
(Source: Ranasinghe A)

The space syntax simulation was performed under the selected case study area to understand the human integration of the space as a quantitative element in order to compare with the CPTEDP and urban design principles.

The space is totally an open space. That is the reason for the same node count. (Physical features that emphasize cognitive movement). The RA (functionality) is quite the same. The space totally focus on a certain functions. The huge variety of integration is a representation of the narrow and wide areas within the space. The sector 1 doesn't match with S.S method. There is a conflict with the quantitative quality of the space. It may cause to crate the diversity of the space, as found in sector 5. At the second stage of the study, the space is analyzed with CPTED principles and urban design principles.

Table 1



The space has only a tree cover which naturally guarded. The area hasn't any natural boundaries. But temporary boundaries can be seen, they have no any connection with previous crime situations. The visual permeability is quite debatable. It will be discussed with Space syntax findings. This is a government owned space. So any organized security couldn't be observed. But there is quite good surveillance than other spaces around this area. Two neighbourhood areas located around this. So a high movement is formed. Most of the people who passed the area has less encourage to use the space as alternative root. The space is act as a backyard of the area, windows and doors have been covered.

6.2 CASE#3 – JINTHUPITIYA

Case study #3 is selected as Jinthupitiya. This is located in Zone 3, which consists with residential and working class. Most of the neighbourhood blocks are located in this area. Those are located at least one boundary facing the main road. According to the police reports the Robbery incidents has taken place around an abounded space.

Jinthupitiya located in Kochchikade North region. Majority is occupied by Tamil People. However, this area consists with Sinhalese, which clearly demonstrate the harmony between different religions. Further, area considered is located in the middle of the grid from the block.

6.2.1 Analysis of the case study – Jinthupitiya

The space syntax simulation done under selected case study area to understand the human integration of the space. And understand the space as a quantitative quality in order to compare with the CPTEDP and urban design principles.

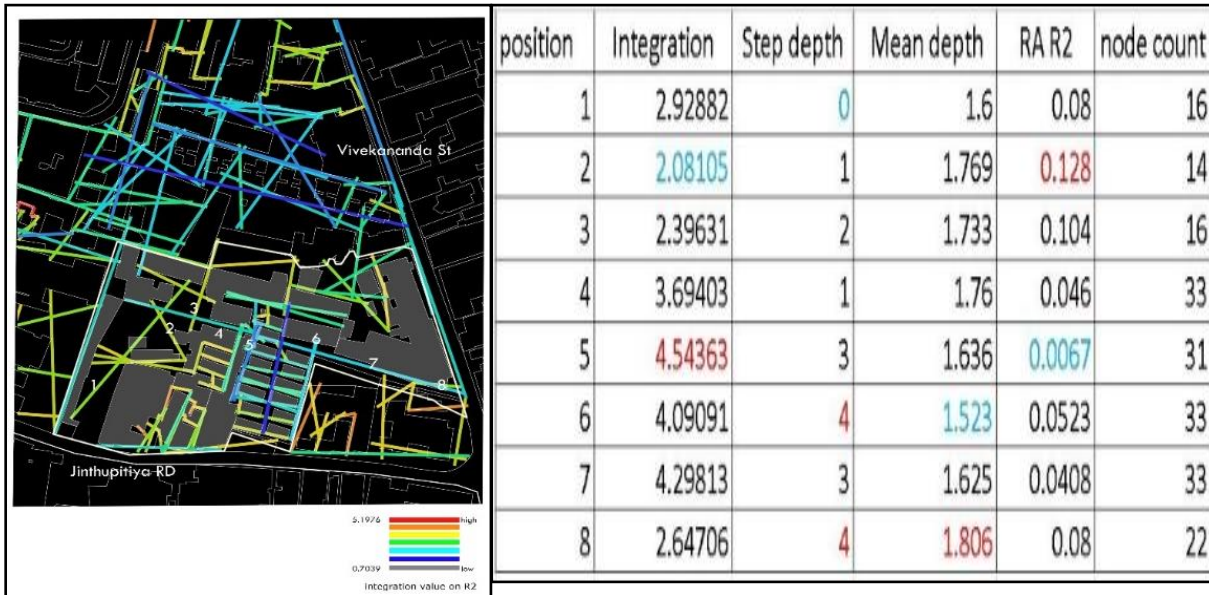
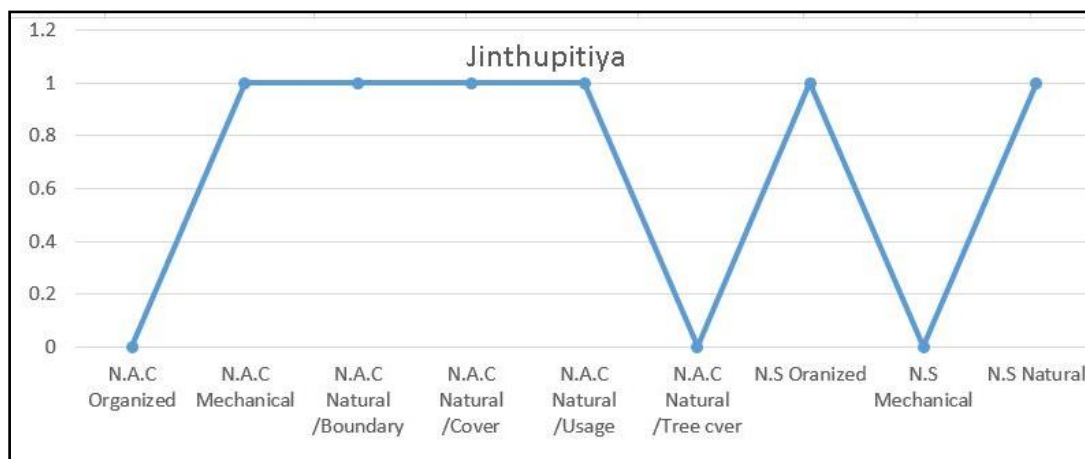

Figure 4, Space syntax simulation (Source: Ranasinghe A)

Mostly this space is functioning according to the space syntax methods, still the space is under the opportunities for crime according to the local police data. It is checked with applying the CPTED principles.

Table 2

Application of CPTED principles



This space is located inside a neighbourhood block. As a result, the access though this space is totally controlled. As expected this space is guarded with gates and locks. The windows are face towards the space. Visually it has much permeability. Few natural tree covers has been observed, and the space is used as an alternative root. Therefore it is quite vivid that the accessibility to outsiders has been eventually grown higher.. Such feature is a beneficial for assailants.. According to the data, half of each attributes identified in Jinthupitiya. There are 75% of good attributes which prevent crime. The space is 25% vulnerable to Crime. The space have guarded well with surveillance and people.

7. Comparison of the Space syntax data and principles

Majority of Positive points in physical attributes are covered with Jinthupitiya (Case#3) space. A high deference in ground cover can be seen between both spaces. Prickerings RD (Case#2) mostly devastates incidents as mentioned before which causes the movement of the victim. It seems that a place which has

Table 3
Comparison of Urban design principles, data formed by space syntax

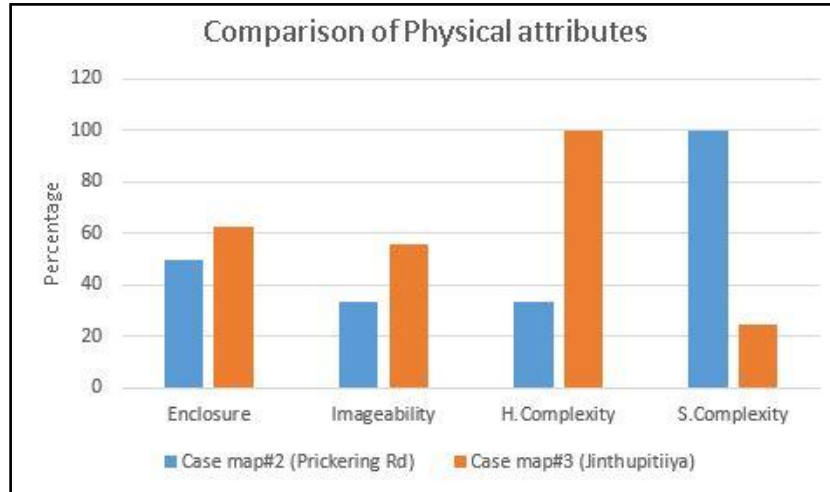

Less contribution to design principles is more vulnerable and it encourages the assailants' territory. And the space has formed according to principles has developed rooting for Robbers. The nature of the incidents can be defined as follows.

- House brake – Static space
- Devastate – The victim is moving
- Robbery – The assailant is moving

Majority of Positive points in physical attributes are covered with Jinthupitiya (Case#3) space. A high deference in ground cover can be seen between both spaces. Prickerings RD (Case#2) mostly the Devastate incidents as mentioned before it cause the movement of the victim. It seems that a place which has less contribution to design principles is more vulnerable and it encourage the assailants' territory. And the space has formed according to principles has developed rooting for Robbers

Table 4
Comparison of urban design principles, data formed by Space syntax

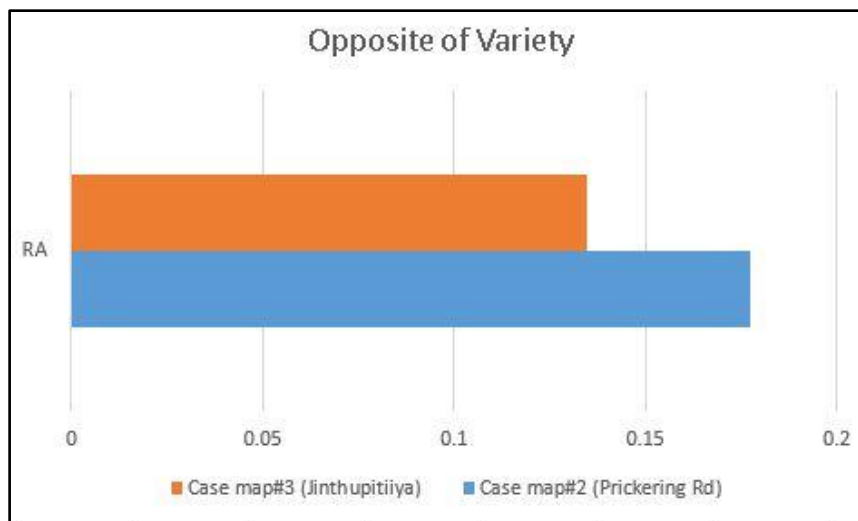

Variety represent by the average of RA (relative asymmetry). High RA implies the low functionality, whereas the low RA replicates high functionality. Case #3 shows the requirements for high functionality. Which means the Variety of Case #3 is higher than case #2.

Legibility is the factor that shows the human’s cognitive understand about the physical attributes such as nodes, edges, paths. The nodes can be identified through the space syntax measures. This shows that the high legibilityby (Prikerings Rd Case#2).

Table 5

Comparison of Urban design principles, data formed by space syntax

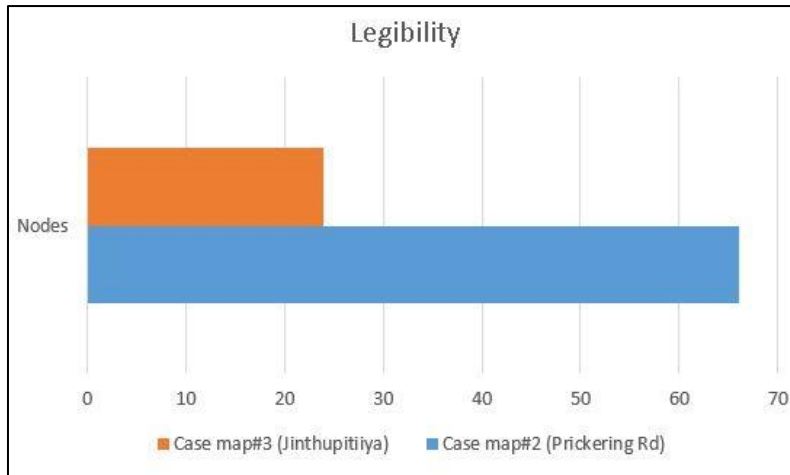

This demonstrates where the design principles have positive value has a positive value on crime prevention. The deference between the rates are increased than urban design principles. But the crime frequency is quite high in these spaces. There is a conflict between the incidents. Devastate is more harm than robbery, but it has opened more opportunities for robbery even this space (Jinthupitya Case#3) has good CPTEDP and UDP.

That describes that more the design principles have been applied supports for every ones act especially Assailants and robbers. robbers. This shows that low urban design principles and CPTEDP applied spaces open for more harmful approaches of Crime such as Devastate than Robberies.

Table 6

Comparison of CPTED principles

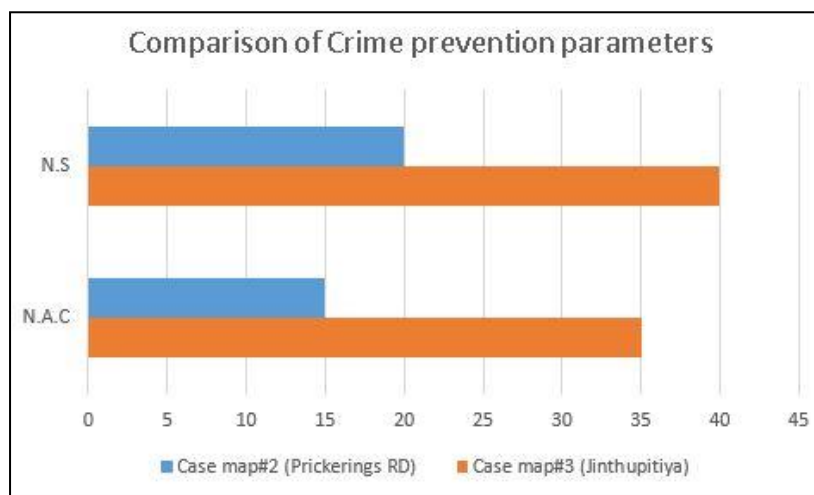

As above both Crime-Space syntax analysis and Principles-Space syntax analysis describe only two similarity. Other attributes are act opposite of each other. Both spaces show plus as well as negative points. Both spaces are poor with regard to area of space and the movement (RA vs Integration). Jinthupitiya Case#3 is exceeding the minimum requirement while Prickerings Case#2 is exceeding its

maximum requirements. Though each space act opposite, both has a negative outcome. But the alternatives and choices have increased on both.

When considering the space syntax analysis, Case#2 describes that the most integrated space (most movable space) is separate from the others. Case#3 describes that both integrated and segregated spaces connect each other. (Mean depth vs Integration). This shows that Casse#3 has physical quality on every space. It may cause to encourage the high frequency of robberies.

Jinthupitiya Case#3 has more plus points of CPTEDP and urban design principles. And high frequency of crime. Prickerings Case#2 has less CPTED and urban design principles and less frequency of crime, but more harmful approach is complained from here.

The special configuration of Case#3 helping the movement of assailant and victim. Case#2 open opportunities for function of assailant and vulnerable for victim.

Spaces positively association with CPTED and UDP has a very good movable space for assailants after a crime is done.

Spaces negatively associated with CPTEDP and UDP have created a cover for assailants, to watch, stay and plan because it is vulnerable for visitors.

8. Conclusion

Most of the time the Space syntax simulated data was coincidental with crime data and the movement. But conflicts with identified space syntax methods.. Those were the reasons for unbalance of physical attributes. E.g. some places haven't been given proper space when considering the movement. Those could be reasons for the crime incidents. This research show how a poor quality of space can affect the social configuration. Even there are urban neighbourhood and plenty of eye on streets. If those types of patterns could be changed, the effect of the incidents should have been changed.

Causes of crimes are still valid even if the CPTED principles and Urban design principles are applied in certain spaces. But a deferent pattern of the intention to crime can be identified in certain spaces. The place where has positive outcome, has complain robberies but the place where has negative outcome, has complained devastate. Where the negativity has increased the harm and vulnerability is high. The real considerations such as onsite checking and the simulation outcome were crossover each other, it was a clue that there is a problem in the space. The simulation outcome is used to predict the movement of human and the quality of the space in order to having an answer to the reasons for certain criminal activities.

8.1 RECOMMENDATIONS

A strong connection in between integration and certain measures could be identified, such as choice, Relative asymmetry and Mean depth. When relatively checking the spaces with Depthmap, the flow of spaces could be visually checked. This is a simulation. The real considerations such as onsite checking and the simulation outcome were crossover with each other, and it was a clue that there is a problem in the space. The simulation outcome is used to predict the movement of human and the quality of the space in order to having an answer to the reasons for certain criminal activities.

The simulation is the best way to identify and predict the outcome of the movement. And the principles can be applied to check the change of the real world. ArcGIS and Landscape integration method can be applied in order to get clear outcome of the relationship between crime and space or movement and space and also to be used as a data base. These can be applied to predict the civilization patterns (e.g. ancient city structures) as well as to predict the designed outcome of spaces through a layout analysis.

Reference

- Alam, D., Islam, S., & Golam, R. (2008). City Growth with Urban Sprawl and Problems of Management for Sustainable Urbanization. *44th ISOCARP Congress* (p. 11). Dalian: isocrap.
- Bartholomew, K., & Ewing, R. (2013). *Pedestrian- and Transit-Oriented Design*. Washington, D.C: Urban Land Institute and American Planning Association.
- Burgess, E. W., & Park. (1925). *The growth of the City ; An introduction to a Research Project*. Chicago: University of Chicago Press.
- Choi, E. (2012). *WALKABILITY AS AN URBAN DESIGN PROBLEM*. Stockholm: KTH Royal Institute of Technology.
- Gordon, D., Dorling, D., Hillyard, P., Pantazis, C., Pemberton, S., & Tombs, S. (2008). *Criminal obsessions: Why harm matters more. 2nd edition*. London: School of Law, King's College London.
- Green cities : good health*. (2014, November, 18). Retrieved from University of Washington, Urban Forestry/Urban Greening Research: https://depts.washington.edu/hhwb/Thm_Crime.html
- Hiller, B., Turner, A., Penn, A., Iida, S., & Al_Sayed, K. (2014). *space syntax methodology 4th edition*. London: Bartlett School of Architecture, UCL.
- Jacobs, J. (1961). *Death and life of great American cities*. New York: Random house Inc.
- Newman, O. (April 1996). *Creating Defensible Space*. New York: U.S. Department of Housing and Urban Development.
- Quinney, R. (1966). Structural Characteristics, Population Areas, and. *Journal of Criminal Law and Criminology*, 45-52.
- Timothy, C., & Zahm, D. (1994). *Crime Prevention through environmental design*. NAHB Land Development magazine.
- Valceanu, D.-G., Kosa, & Tamirjan, D. (2014). Urban landscape as palimpsest. *Urbanism. Arhitectura. Constructii*, 17.
- Whyte, W. (1980). *The Social Life of Small Urban Spaces*. Washington, DC: The Conservation Foundation.
- Wood, E. (1967). *Social Aspects of Housing in Urban Development*. New York: Department of Economic and Social Affairs, UN.

Samarawickrama, Sumanthri, et al (eds), 2018, "Sustainability for people - envisaging multi disciplinary solution": *Proceedings of the 11th International Conference of Faculty of Architecture Research Unit (FARU), University of Moratuwa, Sri Lanka, December 08, 2018* Galle pp. 91–98. ©

EFFECTIVENESS OF A DISCRETELY SUPPORTED SLAB INSULATION SYSTEM IN TERMS OF THERMAL PERFORMANCE

KASUN NANDAPALA¹, MADUJITH SAGARA CHANDRA² & R.U. HALWATURA³

¹Faculty of Industrial and Vocational Technology, University of Vocational Technology, Rathmalana, Sri Lanka.

^{2,3}Department of Civil Engineering, Faculty of Engineering, University of Moratuwa, Sri Lanka

¹kasuncn@gmail.com, ²madujithsagara123@gmail.com, ³rangikauh@gmail.com

Abstract

One of the main issues of the thermal discomfort inside buildings is heat gain from building envelope. As a remedy, active cooling solutions such as air conditioners are commonly used. But that can never be admired owing to the contribution of excessive energy usage and environmental pollution. Hence, passive cooling solutions such as building thermal insulation can be taken as a fruitful solution. Since about 70% of heat gain of buildings occur through roofs, thermal insulation of roofs takes a prominent place in the aforesaid matter. As a result of rapid urbanization and population growth, the amount of usable land for building constructions is very low and the constructions have to be done on a very limited space. There, flat concrete roofs provide additional working spaces and the possibility of future vertical developments with other benefits such as extra robustness and the cyclonic resistance to the structures. Anyhow, utilization of flat concrete roofs is unpopular due to the thermal discomfort in the immediate space beneath. Addressing this drawback of ordinary flat concrete roofs, a new roof slab insulation system introduced having the capability of achieving more than 75% of heat gain reduction. Thermal performance comparison between the novel system and existing roof slabs confirmed the effectiveness of the new system. Further, 50mm thick vegetation was added on top of the novel slab system and thermal performance was compared. Results showed 20% of peak cooling load reduction from new slab system and 21% of peak cooling load reduction in a summer day under tropical conditions when it was vegetated.

Keywords: *Roof slab insulation, Thermal Comfort, Cooling Load, Thermal Insulation, Vegetated slabs*

1. Introduction

The burning issue, global warmth has affected every nook and corner of the globe (Mieziš, Zvaigznitis, Stancioff, & Soefstestad, 2016) and it has negatively affected the thermal comfort inside buildings. Hence, a number of researches are being carried out for finding long lasting solutions for the matter. Recent studies show that, if no necessary steps are taken to reduce the emission of CO₂ and other greenhouse gasses (GHG) to the atmosphere, the average surface temperature of the earth will rise about 1.1 °C- 6.4 °C by the end of 2100 (Aditya et al., 2017). On the other hand, due to the adverse climatic changes the severity and the intensity of natural disasters such as cyclones, snow melting, floods and droughts will be increased (Vázquez Rowe, Kahhat, & Lorenzo-Toja, 2017).

In many cases, active cooling solutions such as air conditioners are commonly used to maintain the internal thermal comfort of buildings. But that practice can never be encouraged owing to the contribution of excessive energy usage and environmental pollution. One of the best solutions to overcome this thermal comfort issue is admitting passive cooling techniques which focus on reducing heat gain/loss of buildings to enhance the indoor thermal comfort through a way of less energy consumption (Kamal, 2012). In there, building thermal insulation plays a major role. Though this consumes additional initial investment, it may be paid back within a reasonable time span (Dwaikat & Ali, 2018; Robati, McCarthy, & Kokogiannakis, 2018; Sterner, 2000). One of the main ways of increasing internal temperature of buildings is solar heat gain through the building envelope. Since about 70% of total heat gain of buildings occur through roofs (Vijaykumar, Srinivasan, & Dhandapani, 2007) thermal insulation of roofs takes a major part in thermal insulation of buildings.

When the aforesaid cyclonic effects are considered, having flat concrete roofs instead of ordinary roofs provide extra robustness to the structure due to its self-weight (Halwatura & Jayasinghe, 2009). Further, having flat concrete roofs will provide extra working space as well as the easy provision of

future vertical developments addressing the scarcity of usable lands for constructions (K Nandapala & Halwatura, 2017; Kasun Nandapala & Halwatura, 2016).

When the roof slab is heated due to the direct exposure of sunlight, the immediate space beneath becomes thermally uncomfortable. Thus, lower degree of thermal comfort of ordinary flat concrete roofs has affected the less popularity of them (Halwatura & Nandapala, 2014).

There are several techniques used in terms of roof thermal insulation, such as applying cool paints (C. Romeo and M. Zinzi, 2013), using a variety of insulation materials in roofing (K. Manohar, 2012) and using rooftop vegetation (S. W. Tsang and C. Y. Jim, 2011). As a fruitful substitution for those systems, a novel roof slab insulation system was introduced addressing both issues, thermal discomfort inside buildings and cyclonic effect. In this study, the thermal performance of the newly introduced roof slab insulation system will be compared with existing flat concrete roofs. Further, the thermal performance of the novel slab insulation system under a 50mm thick vegetation layer on top of the slab will be investigated and the fruitfulness of the innovation will be proved.

2. Objectives

The ultimate objective of the study is to check the effective thermal performance of novel roof slab insulation system. The specific objectives are;

1. To compare the thermal performance of new roof slab insulation system with existing flat concrete roofs.
2. To check the thermal performance of novel system with and without a vegetation layer
3. To find the peak cooling load reduction which can be achieved by the newly designed system with and without a vegetation layer

3. Thermal performance comparison between new roof slab insulation system, existing flat concrete roof and vegetated roof slab

3.1. METHODOLOGY ADAPTED

Small-scale physical model testing was used to fulfil the objective. The used models are as shown in Figure 15. In there, one model was with an ordinary flat concrete slab of 125mm thick and other models were with the new roof slab insulation system with and without 50mm vegetation on top of the slab. The details of the new roof slab insulation system are as shown in Figure 16.



Figure 15, Physical models constructed for thermal performance comparison

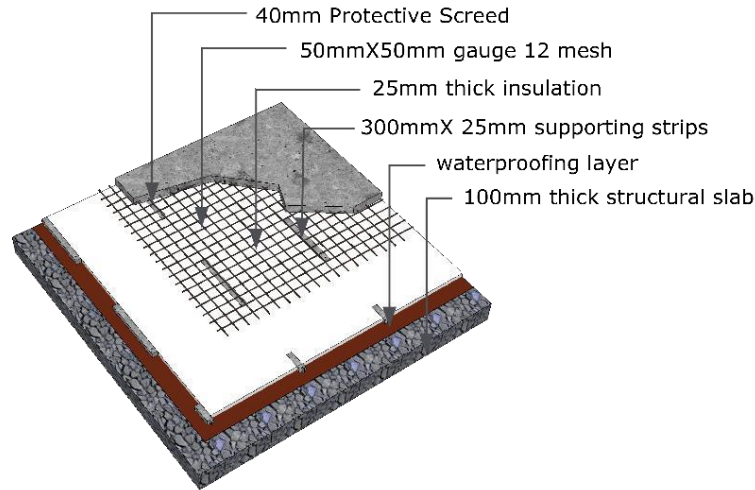

Figure 16, Newly designed roof slab insulation system (Kasun Nandapala & Halwatura, 2016)

Uninterrupted set of temperature readings were taken during continuous five days at ten-minute intervals until a constant ambient temperature was obtained using GL820 Midi Data Logger. The average temperature of each hour was calculated removing outliers and adjusted temperature readings of slab top and slab soffit were used in the comparison.

3.2. RESULTS

The experiment was conducted over a period of 24 hours during continuous five separate days. One graph representing whole five-day results was prepared considering the temperature values with minimum standard deviations. Figure 3 shows the graphical representation of slab soffit and slab top temperature readings of the model with an ordinary flat concrete roof over a time period of 24 hours, Figure 4 shows the graphical representation of slab soffit and slab top temperature readings of the model with the newly designed roof slab insulation system over a time period of 24 hours. In there, as shown in Figure 16, 25mm thick Expanded Polystyrene (EPS) layer with the thermal conductivity of 32 mW/mK was used as the thermal insulation barrier. Figure 5 shows the variation of slab top and soffit temperature readings of the new roof slab insulation system when there is a 50mm vegetation layer contained with an ordinary grass layer with a height about 60mm.

All the results were taken in 2nd week of September 2018 in Sri Lanka under tropical climatic conditions.

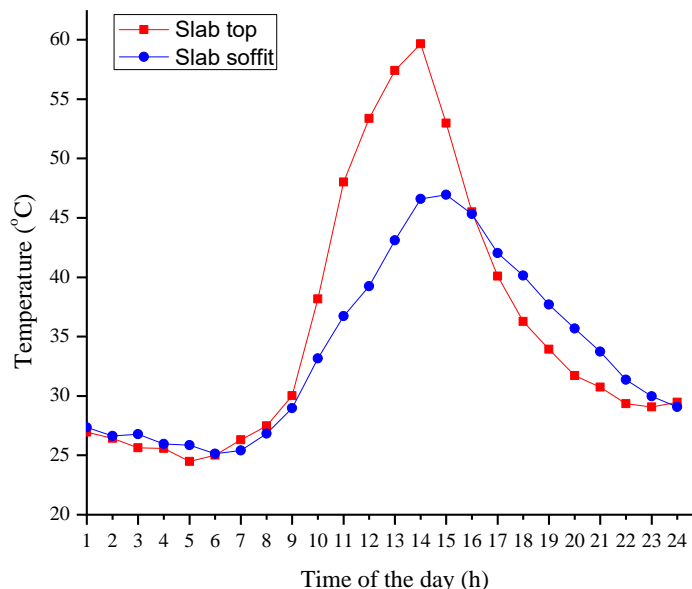

Figure 17, Slab top and slab soffit temperature readings of the model with an ordinary flat concrete roof over a period of 24 hours

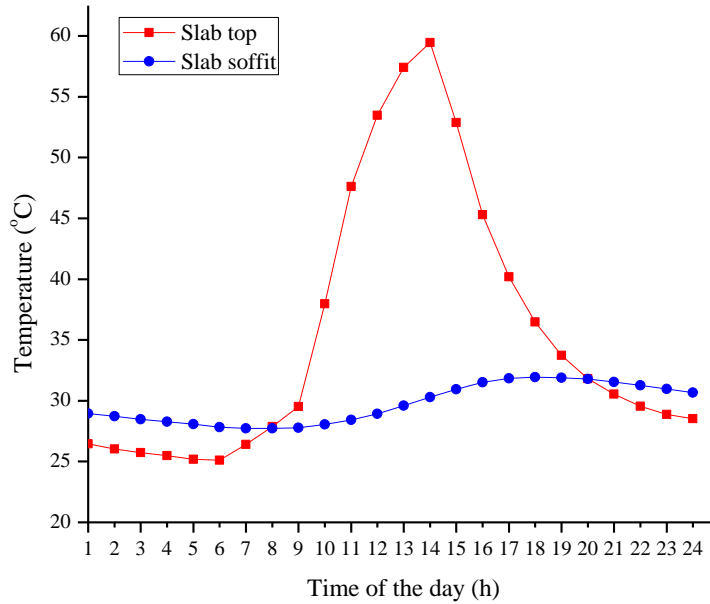

Figure 18, Slab top and slab soffit temperature readings of the model with new roof slab insulation system over a period of 24 hours

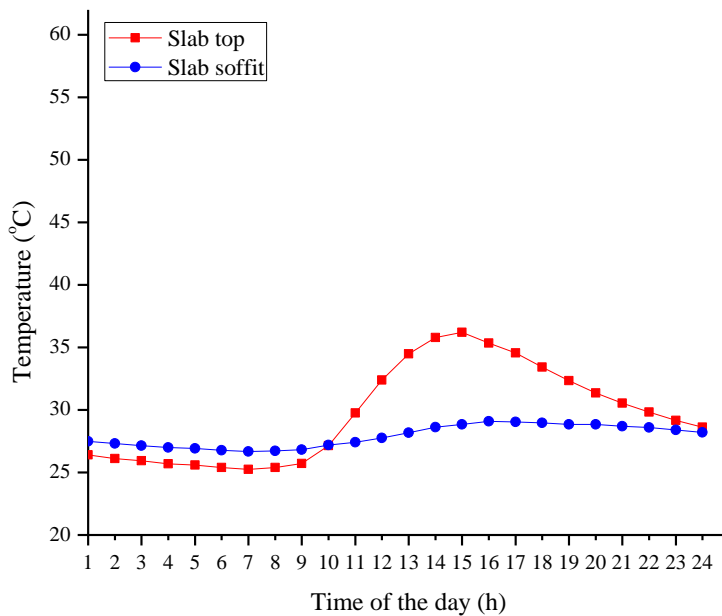

Figure 19, Slab top and slab soffit temperature readings of the model with a vegetated roof slab insulation system over a period of 24 hours

Self-insulation characteristics of the flat concrete roof due to the effect of thermal mass can be seen through Figure 17. However, in the case of the ordinary flat concrete roof, the slab soffit temperature has reached 45.5 °C which can be considered as a higher value which definitely results in thermal discomfort. When the novel slab insulation system was treated with a 50mm thick vegetation layer, the slab top temperature values show an outstanding reduction.

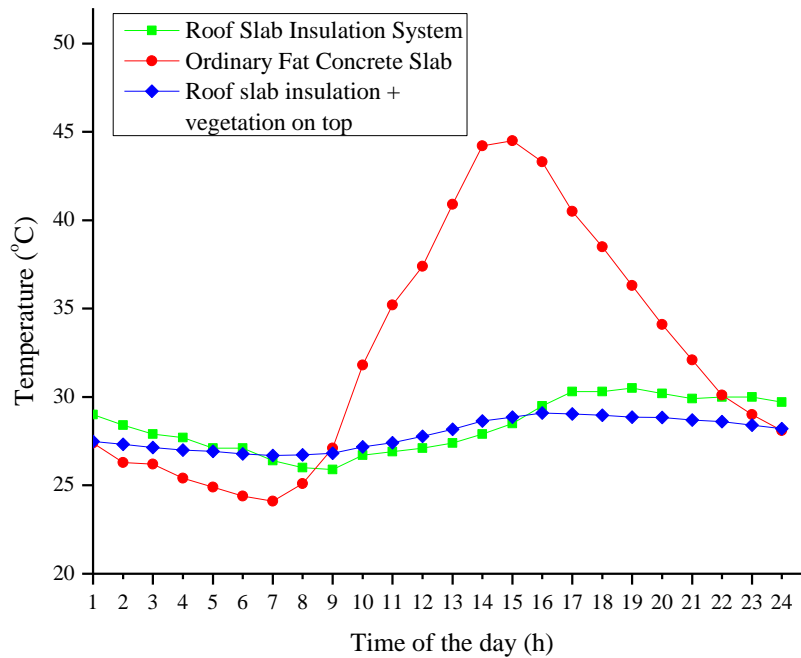

Figure 20, Slab soffit temperature readings of the considered three models over a period of 24 hours

Figure 20 clearly elaborates that the maximum slab soffit temperature at the presence of new roof slab insulation system has limited to 30.5 °C which can be considered as a satisfactory value. That value shows a further reduction to 29.1 °C at the presence of 50mm thick vegetation layer.

At the presence of the new roof slab insulation system, the slab soffit temperature lies between 25.9 °C and 30.5 °C. It is a very satisfactory condition comparing with the situation of the ordinary flat concrete roof. Since the temperature further goes down when it comes to the human occupation height, utilization as well as the capacity of air conditioners can be effectively mitigated. Anyhow, the vegetation layer has limited the slab soffit temperature in between 27 °C and 29.1 °C. But it is a slight difference from the performance of novel slab without vegetation and will be clearly discussed with respect to cooling load reduction under section 4.

It has been proven in a previously done study by one of the authors that, this kind of systems are having a heat gain reduction about 75% (Halwatura & Jayasinghe, 2008). According to the above results and since the new system was developed considering drawbacks of existing slab insulation systems, it can be predicted that the new roof slab insulation system is having a heat gain reduction more than 75%.

4. Peak cooling load reduction of the system

4.1. METHODOLOGY ADAPTED

A computer simulation was performed using the software package “Design Builder V5” to find out the cooling load reduction of a selected office building. A typical 15m x 15m office building was used since previous literature is available for such a building. Other housing elements were included with less influence since the main objective was to study the heat gain effect through the roof. In there, external walls were selected to be 225mm thick ordinary brick walls, no windows were placed in East and West walls, and windows in North and South directions were shaded with 1m overhangs by means of preventing direct solar radiation penetration. The model used in the simulation is as shown in Figure 21.

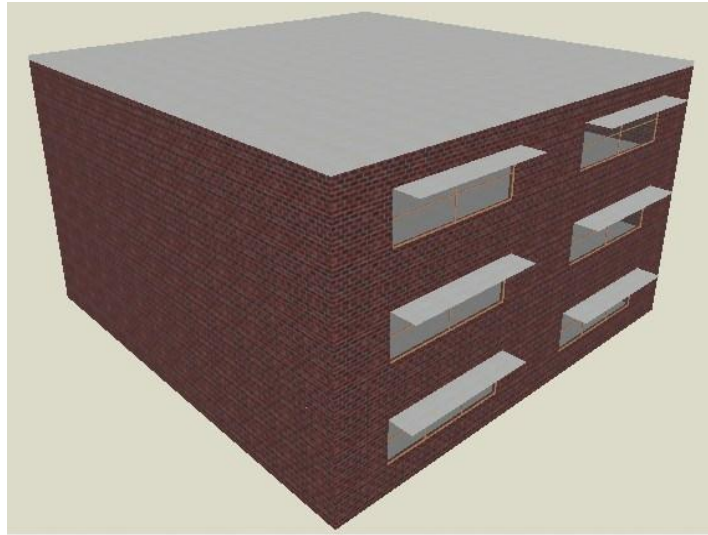

Figure 21, Virtual model used in computer simulation

4.1. RESULTS

Figure 21 office building shown in Figure 21 was analyzed in “Design Builder V5” to figure out the cooling load requirement to obtain neutral human comfort conditions on a typical summer day. Here, neutrality temperature was used as 26°C which has been mentioned as a reasonable value for tropical conditions (Jayasinghe, Attalage, & Jayawardena, 2002).

Table 7, Cooling load demand over a period of 24 hours

Time of the day (h)	Cooling required (kW)		
	Uninsulated slab	Roof slab insulation system	Roof slab insulation system +50mm vegetation on top
1	51.0030	55.2007	56.153
2	50.5711	55.0891	56.2200
3	48.4080	52.9293	54.1391
4	46.0967	50.6569	51.9040
5	44.2352	48.8192	50.0772
6	42.4248	46.9857	48.2246
7	41.4340	45.8303	47.0408
8	40.2569	43.3924	44.5793
9	52.1464	52.4538	53.4592
10	53.4525	49.2790	50.1252
11	59.9516	51.1731	51.6680
12	66.0990	53.1785	53.2508
13	70.0835	57.4962	54.5302
14	75.7483	60.7652	56.7003
15	81.1211	60.7652	59.6103
16	83.8256	64.0852	62.7123
17	83.6048	67.1330	65.7241
18	74.0339	62.0511	60.7000
19	73.0867	67.3199	66.3531
20	68.8214	66.1350	65.5401
21	65.9136	64.0991	63.8983
22	61.6634	61.5979	61.7556
23	56.9902	58.7270	59.1940
24	52.4503	55.6461	56.3776

The cooling energy requirement of aforesaid building at the presence of thermally insulated slabs and thermally uninsulated slab are as listed in Table 7. The cooling load reduction calculation is as mentioned below;

Cooling load reduction with respect to novel slab system without vegetation and ordinary uninsulated roof slab

$$\text{Cooling load reduction} = [1 - (67.3199/83.8256)] \times 100\% = 19.69\% \approx 20\%$$

Cooling load reduction with respect to novel slab system with vegetation and ordinary uninsulated roof slab

$$\text{Cooling load reduction} = [1 - (66.3531/83.8256)] \times 100\% = 20.84\% \approx 21\%$$

Calculations show a 20% cooling load reduction due to novel roof slab insulation system over ordinary flat concrete roof slabs. The value gets a positive advancement about 1% due to the vegetation layer. But such a vegetation requires additional investment as well as proper maintenance. Since the cooling load difference is about 1%, roof slab insulation system without any vegetation can be chosen as the most fruitful solution.

3. Conclusion

The newly designed roof slab insulation system can be used to fulfil both requirements; indoor thermal comfort of buildings and cyclonic resistance addressing the key drawbacks of ordinary flat concrete roofs.

Since the comparison with literature data deviated that novel system can achieve more than 75% heat gain reduction under tropical climatic conditions and it was proven through performance analysis that new system provides about 20% cooling load reduction on a typical summer day it can be concluded that newly designed roof slab insulation system is suitable for addressing existing indoor thermal comfort issues of countries under tropical climatic conditions in an energy efficient manner providing extra cyclonic resistance to the structure too. At the presence of new roof slab insulation system, requirement of air conditioning equipment will be reduced and expected human comfort condition can be fulfilled with low capacity air conditioning equipment.

References

- Aditya, L., Mahlia, T. M. I., Rismanchi, B., Ng, H. M., Hasan, M. H., Metselaar, H. S. C., Aditya, H. B. (2017). A review on insulation materials for energy conservation in buildings. *Renewable and Sustainable Energy Reviews*, 73, 1352–1365. <https://doi.org/10.1016/j.rser.2017.02.034>
- C. Romeo and M. Zinzi. (2013 December). Impact of a cool roof application on the energy and comfort performance in an existing non-residential building. A Sicilian case study. *Energy Build.*, vol. 67, pp. 647–657
- Dwaikat, L. N., & Ali, K. N. (2018). Green buildings life cycle cost analysis and life cycle budget development: Practical applications. *Journal of Building Engineering*, 18, 303–311. <https://doi.org/10.1016/j.jobeb.2018.03.015>
- Halwatura, R., & Nandapala, K. (2014). Prioritizing effective means of retrofitting flat slabs to meet public demands in order to promote sustainable built environment, in: *Proceedings of the Special Session on Sustainable Buildings and Infrastructure*. 5 Th International Conference on Sustainable Built Environment, Volume 1.
- Halwatura, R. U., & Jayasinghe, M. T. R. (2008). Thermal performance of insulated roof slabs in tropical climates. *Energy and Buildings*, 40(7), 1153–1160. <https://doi.org/10.1016/j.enbuild.2007.10.006>
- Halwatura, R. U., & Jayasinghe, M. T. R. (2009). Influence of insulated roof slabs on air-conditioned spaces in tropical climatic conditions—A life cycle cost approach. *Energy and Buildings*, 41(6), 678–686. <https://doi.org/10.1016/j.enbuild.2009.01.005>
- Jayasinghe, M. T. R., Attalage, R. A., & Jayawardena, A. I. (2002). Thermal comfort in proposed three-storey passive houses for warm humid climates. *Energy for Sustainable Development*, 6(1), 63–73. [https://doi.org/10.1016/S0973-0826\(08\)60300-2](https://doi.org/10.1016/S0973-0826(08)60300-2)
- K. Manohar. (2012). Experimental Investigation of Building Thermal Insulation from Agricultural By-products. *Br. J. Appl. Sci. Technol.*, vol. 2, no. 3, pp. 227–239.
- Kamal, M. A. (2012). An Overview of Passive Cooling Techniques in Buildings: Design Concepts and Architectural Interventions. *Civil Engineering*, 55(1), 14.

- Miezis, M., Zvaigznitis, K., Stancioff, N., & Soeftestad, L. (2016). Climate Change and Buildings Energy Efficiency – the Key Role of Residents. *Environmental and Climate Technologies*, 17(1), 30–43. <https://doi.org/10.1515/rtuect-2016-0004>
- Nandapala, K., & Halwatura, R. (2017). Developing a Structurally Sound and Durable Roof Slab Insulation System for Tropical Climates (Vol. volume 1, pp. 201–214). Presented at the 8th International Conference of Faculty of Architecture Research Unit (FARU), University of Moratuwa, Taj Samudra Hotel.
- Nandapala, Kasun, & Halwatura, R. (2016). Design of a durable roof slab insulation system for tropical climatic conditions. *Cogent Engineering*, 3(1), 1196526. <https://doi.org/10.1080/23311916.2016.1196526>
- Robati, M., McCarthy, T. J., & Kokogiannakis, G. (2018). Integrated life cycle cost method for sustainable structural design by focusing on a benchmark office building in Australia. *Energy and Buildings*, 166, 525–537. <https://doi.org/10.1016/j.enbuild.2018.02.034>
- S. W. Tsang and C. Y. Jim. (2011). Theoretical evaluation of thermal and energy performance of tropical green roofs. *Energy*, vol. 36, no. 5, pp. 3590–3598.
- Sterner, E. (2000). Life-cycle costing and its use in the Swedish building sector. *Building Research & Information*, 28(5–6), 387–393. <https://doi.org/10.1080/096132100418537>
- Vázquez-Rowe, I., Kahhat, R., & Lorenzo-Toja, Y. (2017). Natural disasters and climate change call for the urgent decentralization of urban water systems. *Science of The Total Environment*, 605–606, 246–250. <https://doi.org/10.1016/j.scitotenv.2017.06.222>
- Vijaykumar, K. C. K., Srinivasan, P. S. S., & Dhandapani, S. (2007). A performance of hollow clay tile (HCT) laid reinforced cement concrete (RCC) roof for tropical summer climates. *Energy and Buildings*, 39(8), 886–892. <https://doi.org/10.1016/j.enbuild.2006.05.009>

Samarawickrama, Sumanthri, et al (eds), 2018, "Sustainability for people - envisaging multi disciplinary solution": *Proceedings of the 11th International Conference of Faculty of Architecture Research Unit (FARU), University of Moratuwa, Sri Lanka, December 08, 2018* Galle pp. 99–106. ©

IMPACT OF SCHEDULE COMPRESSION ON SUCCESSFUL DELIVERY OF SRI LANKAN CONSTRUCTION PROJECTS

WICKRAMASINGHE B.M.S.M¹ & DISARATNA V.²

^{1,2}University of Moratuwa, Moratuwa, Sri Lanka

¹*Subhanimwickramasinghe@gmail.com*, ²*Vijitha.disaratna@gmail.com*

Abstract

Scheduling is the most critical aspect to be considered in construction planning. When the project is slipping over its planned schedule, delay becomes reality. Delays in construction is one of recurring problem that can challenge on successful delivery of projects. Also delays are subjected to generate a considerable amount of financial losses to the contractors. Accordingly, if such situation is encountered the contractors are usually compelled to accelerate the projects. Previous researchers have stressed schedule compression as a commonly used approach to expedite the construction to recover lost time due to delay or to meet revised deadline during an extended project duration. However, when expedite the project, though the time saved, other performance parameters are often sacrificed for the sake of remaining ahead of the schedule. Therefore, this research aims to explore the impact of schedule compression on successful delivery of Sri Lankan construction projects. To accomplish the aim, ten semi-structured interviews were conducted with experts including Quantity Surveyors, Contract Administrators, Project Managers and Engineers. Subsequently, the gathered information was analysed rigorously through content analysis and explored that, acceleration through schedule compression creates negative, positive and neutral impacts on project performance parameters in terms of cost, quality and health and safety.

Keywords: *Schedule compression; Construction delay; Performance parameters; Impacts; Sri Lanka.*

1. Introduction

Construction can be defined as a cannonading industry that preforms a vital role in rapidly growing global economy (Uthpala and Ramachandra, 2015). According to Gao, Song and Webb (2015), there should be a proper time management to survive within the construction industry for the contractors, since most of the projects are met with the challenge of stringent timelines or the threat of exorbitant damages for delay. Thus, contractors are usually compelled to accelerate the projects using schedule compression to expedite the construction in order to recover the lost time due to a delay or to meet revised deadline during an extended project duration (Ssemwogerere, 2011).

Bakry, Moselhi and Zayed (2014) expounded schedule compression as an effort to reduce construction project durations for the purpose of recovering delays. Eden and Howick (2001) mentioned that, when the time available to complete activities associated with a construction is perceived to be far shorter than required, project performance is suffered. Henceforth, this research aims to explore the impacts of schedule compression on successful delivery of Sri Lankan construction projects.

2. Literature Synthesis

Time is the essence of a construction contract (Arditi, Cheung and Shi, 2001). Further to authors, when the contractors fail to complete their construction within a specified contract period, delay becomes the reality in a project. Thus, the contractors' rate of performance for the remaining construction work have to be increased by schedule compression in order to overcome delay (Gunatilake and Theivendran, 2015). Various terminologies are used for schedule compression in the construction industry as project acceleration, expediting and project time crashing (Bakry et al, 2014; Roofigari-esfahan, 2011). Chang, Hanna, Lackney and Sullivan (2007) expounded that, schedule compression is an effort to reduce available time to complete a project.

Schedule compression can be broadly classified into two as planned and unplanned schedule compression (Mansur, Mohamed and Putra, 2003). Apart from that, it can be classified into two as mandated acceleration and constructive acceleration (Chang et al, 2007). Further to authors, mandated acceleration occurs when the owner requests an earlier completion than agreed while constructive acceleration occurs due to requirements of the contractor. Mubarak (2015) stated that, need of expedition may occur due to several situations. In terms of parties involved in a project, both the contractors and the owners frequently need to compress the project duration (Bakry et al, 2014). Contractor is basically compelled to accelerate for the purpose of recovering delays, avoiding penalties, avoid adverse weather condition and to have benefits from early delivery (Bakry, et al, 2014; Mubarak, 2015). On the other hand, owner needs to compress project duration to address market demand and achieve business opportunities (Hanna and Noyce, 1998; Mubarak, 2015).

Compressing project duration is performed by means of schedule compression techniques (Gao et al, 2015; Gunatilake and Theivendran, 2015). The Construction Industry Institute (CII) has suggested more than ninety techniques for schedule compression (Mubarak, 2015). In Sri Lankan context, Gunatilake and Theivendran (2015) have identified eleven techniques which are mostly used to perform schedule compression. Schedule compression is a challenging task to project teams where there is a need to reduce project durations (Alshibani and Moselhi, 2013).

Previous studies have identified that though the compressing project duration save the time achieving time performance, it challenges on successful delivery of construction projects creating impacts on other performance parameters. Ankrah and Proverbs (2005) emphasized that, performance in the construction context may be approached from two perspectives as,

- Business performance of organisations.
- Project performance.

Evaluating the successful delivery of construction projects has traditionally been grounded to industry accepted parameters as cost, time, quality, productivity and safety (Hughes, Tippett and Thomas, 2004). Axiomatically, if the construction is completed on time, within the budget, without any accidents, accordance with specified quality and overall client satisfaction, that project can be acknowledged as a well performed one (Abdallahman, Pakir and Omran, 2012; Chan and Kumaraswamy, 2002).

Typically, project performance parameters can be defined from the 'Iron Triangle' where time, cost and quality are placed at the heart of the success of a project (Atkinson, 1999; Pillai, Joshi and Rao, 2002). Nevertheless, Chan A.P.C and Chan (2004) have expounded several parameters other than indicated in iron triangle that use to evaluate project performance. Accordingly, the most recent literature publications (2000-2018) on project performance were reviewed to explore the most significant parameters to evaluate the project success as indicated in Table 1.

Table 8: Review of Performance Parameters

Author/ Authors	A1	A2	A3	A4	A5	A6	A7	A8	A9	A10	Occurrence %
Time	✓		✓	✓	✓	✓	✓	✓	✓	✓	90%
Cost	✓		✓	✓	✓	✓	✓	✓	✓	✓	90%
Quality	✓	✓	✓		✓	✓	✓	✓		✓	80%
Health & Safety	✓	✓	✓		✓	✓	✓	✓	✓		80%
Client satisfaction	✓	✓		✓		✓	✓	✓		✓	70%
Productivity		✓		✓			✓	✓			40%
Contractor satisfaction			✓		✓			✓			40%
Design team satisfaction			✓		✓	✓		✓			40%
Functionality			✓		✓			✓			30%
Profitability				✓				✓			20%

[Sources: A1 (Abdalrahman, Pakir, and Omran, 2012), A2 (Junnonen and Kärnä, 2016), A3 (Chan A.P.C and Chan , 2004), A4 (Aouad, Cooper and kagioglou, 2001), A5 (Willar, 2017), A6 (Ngacho and Das, 2017), A7 (Anumba, Beatham, Hedgess and Thorpe, 2004), A8 (Akintoye and Takim, 2002), A9 (Proverbs and Xiao, 2003), A10 (Ankrah and Proverbs, 2005)]

According to above review, cost, time and quality are prominent as indicated in iron triangle. Health and safety and client satisfaction are also in the front line having a higher occurrence while the other parameters are at the bottom line over the average. Delivering projects within the stipulated completion date is one of the basic parameters of measuring the successfulness of a project (Aigbavboa, Mukuka and Thwala, 2015). Generally, in terms of performance, the main focus of schedule compression is achieving time performance. Accordingly, the study to be continued exploring the impact on other performance parameters highlighted above while trying to have time performance in a situation of delay to recover lost time as a result of delay or to reach revised deadline during a time extension.

3. Research Method

This research was aimed to carry out an in depth study on the impacts of schedule compression on project performance in the Sri Lankan construction projects. The qualitative research approach was followed steering ten semi-structured interviews targeting experts who have experience in schedule compression including contract administrators, project managers, engineers and quantity surveyors in contractor category for the purpose of collecting reliable data. Profile of respondents is detailed in Table 2. Finally, the gathered information was analyzed rigorously through manual content analysis to derive conclusions and recommendations. The findings are discussed in the subsequent section.

Table 9: Profile of Interviewees

Respondent	Profession	Designation	Field of Expertise	Industry Experience
Respondent (R1)	Quantity surveyor	Contract Administrator	Contract Administration	40 years
Respondent (R2)	Quantity Surveyor	Project Quantity Surveyor	Quantity Surveying	18 years
Respondent (R3)	Quantity Surveyor	Project Quantity Surveyor	Quantity Surveying	5 Years
Respondent (R4)	Civil Engineer	Director- Projects	Project Management	25 years
Respondent (R5)	Civil Engineer	General Manager	Project Management	21 Years
Respondent (R6)	Civil Engineer	Project Manager	Project Management	16 Years
Respondent (R7)	Civil Engineer	Project Manager	Project Management	23 Years
Respondent (R8)	Civil Engineer	Planning Engineer	Project Planning	10 Years
Respondent (R9)	Civil Engineer	Deputy General Manager - Compliance	Quality Assurance and Quality Control, Health and Safety	28 Years
Respondent (R10)	Facilities Manager	Health and Safety Engineer	Occupational Health and Safety	12 years

4. Research Findings

The content analysis was carried out on the collected data for the purpose of exploring the impacts of schedule compression on project performance in terms of the most prominent performance parameters.

4.1. MEANS OF SCHEDULE COMPRESSION IN SRI LANKAN CONTEXT

As stated by previous researchers, expedition of projects through compressing duration is performed by means of schedule compression techniques. Thus, this research was carried out focusing on the schedule compression techniques mostly used in current Sri Lankan construction industry. Total number of eleven schedule compression techniques used for the expedition of construction projects

were identified through literature review and two numbers of schedule compression techniques were added by experts making the total number of techniques in to thirteen as shown in Table 3.

Table 10: Mostly Used Schedule Compression Techniques

From Literature Review	Detailed Project Planning
	Working overtime
	Sub-contractor and joint ventures
	More detailed sub-contractor schedule
	Construction sequencing
	Staff project with most efficient crews
	Employ additional workers
	Optimal material management for critical items
	Participative management
	Increase supervisor to worker ratio
	Provide employees with incentives
From Experts' Interview	Use pre-fabricated components
	Shift work

4.2. IMPACT OF SCHEDULE COMPRESSION ON PERFORMANCE

The time, cost, quality and safety parameters are inter-related. Failure of one aspect may lead the unsuccessfulness of another. The findings of the research portrayed that there are some crucial aspects which affect the cost, quality, health and safety performance and client satisfaction while using schedule compression techniques to achieve time performance.

4.2.1 Detailed project planning

Detailed project planning impacts negatively on the cost performance by creating increment in cost due to additional resources than planned. Additional resource requirement includes labour and plant excluding material. Further, compressing project duration using this technique impacts health and safety performance in both aspects of physical and psychological. Hard schedule creates mental stress on workers and it makes possibility of accidents as the workers may lose concentration on the safety plan. Proper detailed project planning improves the quality performance. It stresses to follow correct practices and ensures strength, functionality and finishing even in a situation of delay. However, industry is not aware on the ways of impacting on client satisfaction while adopting this technique for acceleration.

4.2.2 Working overtime

Working overtime subject to generate adverse impacts on cost performance through generating additional cost for salary, project facilities, general services and transportation. Fatigue and tiredness during overtime period lead to lose concentration on safety plan and quality policies. Accordingly, it increases possibility of accidents and demotivates the workers imposing negative impact on health and safety performance both physically and psychologically. Also, it creates adverse effect on the quality performance creating defects in construction. Additionally, awareness on the way of impacting on client satisfaction while using overtime is lacking in the industry.

4.2.3 Use sub-contracts and joint ventures

All apparent additional costs are covered by sub-contractor package and there is a slight negative impact on cost due to additional administrative cost required by this technique. Sub-contractor team basically depends on the main contractor's safety procedures. When more parties are involved in the project with different disciplines, unfamiliar safety culture is created for the workers and it increases the possibility of accidents. Accordingly, this technique impacts adversely on health and safety performance. Using sub-contractors and joint ventures impacts adversely on quality performance due to mismatch between working style of project contributors and the main contractor creating inaccuracy

of work, low strength and less functionality. Impact on client satisfaction is unclear due to lack of awareness in the industry on that area.

4.2.4 More detailed sub-contractor schedule

More detailed sub-contractor schedule impose a positive impact on cost performance during acceleration. Possibility of increment in cost for further delays is avoided by this technique maintaining a baseline for the work through scheduling all the sub-contractors' work. Also, when details are more, risk factor goes down and as a result of that, possibility of accidents is reduced. Accordingly, it affects health and safety performance positively. Further, more detailed schedule clearly defines the quality policies. Thus, preparation of in-detail schedule, rather than giving just scope to the sub-contractors improves the quality ensuring functionality, finish and accuracy of work. However, industry is not aware on the impact created by this technique on client satisfaction.

4.2.5 Construction sequencing

Construction sequencing creates significant impact on cost performance of the project. Shuffled sequence requires additional storage, labor and plant rather than planned for the moment. On the other hand, there is an additional cost due to wastage. Also, this technique impacts on health and safety performance due to unfamiliar sequence. It increases the possibility of the accidents. Moreover, shuffled sequence may lead to quality drop in project. In this technique also contractors are not aware on the ways that impact client satisfaction.

4.2.6 Staff project with most efficient crews

Staff project with most efficient crew accelerate the project increasing the rate of progress with high efficiency level of staff. But the contractor has to pay more for the salaries and additional facilities required by the staff and it impacts on cost performance negatively. Staff with efficient employees is beneficial to have higher productivity. However, it may psychologically impacts on the employees due to stress originated via high workload. Additionally, employees with higher efficiency level subject to ensure quality without any defect by following correct construction practices. Even though the contractors use this technique to accelerate project, they are not aware of the impact of this technique on client satisfaction.

4.2.7 Employ additional workers

The term additional workers implies additional cost itself. There is increment of cost due to salaries, additional facilities, general services and transportation. Accordingly, employment of additional workers create adverse impact on cost performance while acceleration. Employing additional workers for acceleration add a risk factor to the health and safety performance through probable accidents as the additional workers are unfamiliar with the site safety culture. Allocation of additional workers over the optimum number may allow to casual chats between workers. Consequently, workers may lose concentration on the work and it creates adverse impact on quality performance. Apart from that industry is not aware on the impact on client satisfaction by employing additional workers in acceleration.

4.2.8 Increase supervisor to worker ratio

Increment in supervisors negatively impacts on the cost performance by increasing cost due to salaries, additional facilities and general services. On the other hand, this technique has a negative effect on health and safety performance in aspect of psychology since more supervision imposes high workload and mental stress on workers. However, increasing supervisor to worker ratio improves the quality of construction. When supervision is more, quality is ensured through stressing to follow correct construction practices and it ensures the quality. There is a lack of awareness on impact of this technique on client satisfaction in terms of performance.

4.2.9 Provide employees with incentives

Incentive schemes are always subject to create negative impacts on cost performance as it is associated with a monetary bonus. Workers get payment upon the completion of a target. So they focus only on completion of work and lose concentration on safety procedures resulting possibility of accidents. Also improper incentive schemes demotivate workers. Accordingly, providing incentives has a negative impact on health and safety both in aspects of physical and psychological. Further, losing concentration

on quality policies imposes adverse impact on performance by dropping quality. However, awareness on client satisfaction while using this technique is lacking.

4.2.10 optimal material management for critical items

This technique imposes a positive impact on cost by minimizing wastage and avoiding further delays. As this is a strategy associated with material management, neutral impact is created on the health and safety performance. Apart from that, this technique impose a positive impact on quality performance ensuring that the quality material are used in construction. However, there is a lack of awareness on client satisfaction while using this technique.

4.2.11 Participative management

Participative management is a management strategy which is done by using in-house resources. Therefore, neutral impact is created on the cost performance. However, this technique impacts on quality and health and safety positively as more experienced workers know the way of doing their specialized work in the optimum way within implemented safety plan and quality policies. Apart from that, there is a lack of awareness on impact of this technique on client satisfaction in terms of performance.

4.2.12 Use pre-fabricated components

There is a significant impact on cost when using pre-fabricated components as it incurs an additional cost due to transportation of components. Also, there is a requirement of heavy equipment for handling them. On the other hand, use of pre-fabricated components impacts on health and safety performance adversely by creating a hazardous environment at site due to heavy equipment. In terms of quality, this technique negatively impact on quality performance as there is a possibility of defects in joints of pre-fabricated components due to lack of knowledge on pre-fabrication technology. However, industry is not aware on the impact created by this technique on client satisfaction.

4.2.12 Shift work

There is an increment in additional cost due to salary, transportation, additional facilities and general services required to provide for workers during shifts. Accordingly, there is a significant adverse impact on cost imposed by shift work. Apart from that, during night shifts, workers lose focus on quality policies and safety plan due to sleepiness imposed by working out of circadian rhythms of people. This creates adverse impact on health and safety performance by increasing possibility of accidents and quality performance by dropping quality. There is a psychological impact due to continuous nightshifts as well. However, awareness on the way of impacting on client satisfaction while using shift work is lacking in the industry.

5. Conclusions

Schedule compression is used by contractors to recover lost time and to meet deadline of extended project duration. However, while using schedule compression techniques, performance is impacted in terms of cost, quality and health and safety. Most of the techniques create negative impact on performance parameters and some of techniques impose positive impact. These explored impacts are summarized in Table 4.

Table 11: Impact of Schedule Compression Techniques on Performance Parameters

Cost Performance		Health and Safety Performance		Quality Performance	
Negative Impact	Detailed Project Planning	Negative Impact	Detailed Project Planning	Negative Impact	Use Pre-fabricated Components
	Working Overtime		Working Overtime		Working Overtime
	Use Sub-contracts and Joint Ventures		Use Sub-contracts and Joint Ventures		Use Sub-contracts and Joint Ventures
	Staff Project with Most Efficient Crews		Provide Employees with Incentives		Employ Additional Workers

	Construction Sequencing		Construction Sequencing		Construction Sequencing
	Employ Additional Workers		Employ Additional Workers		Provide Employees with Incentives
	Shift Work		Shift Work		Shift Work
	Use Pre-fabricated Components		Use Pre-fabricated Components	Positive Impact	Detailed Project Planning
	Increase Supervisor/Worker Ratio		Increase Supervisor/Worker Ratio		Increase Supervisor/Worker Ratio
	Provide Employees with Incentives	Neutral Impact	Optimal Material Management for Critical Items		Participative Management
Neutral Impact	Participative Management	Positive Impact	More Detailed Sub-contractor Schedule		Staff Project with Most Efficient Crews
Positive Impact	More Detailed Sub-contractor Schedule		Participative Management		More Detailed Sub-contractor Schedule
	Optimal Material Management for Critical Items		Staff Project with Most Efficient Crews		Optimal Material Management for Critical Items

6. References

Abdalrahman, S., Pakir, K., and Omran, A., 2012. Project performance in Sudan construction industry: A case study. *Global journal of accounting and economic research*, Volume 1, pp. 55-78.

Aigbavboa, C., Mukuka, M., and Thwala, W., 2015. Effects of construction projects schedule overruns: A case of the Gauteng Province, South Africa. s.l., Elsevier B.V, pp. 1690-1695.

Akintoye, A., and Takim, R., 2002. Performance indicators for successful construction project performance. *Association of Researchers in Construction Management*, Volume 2, pp. 545-555.

Alshibani, A., and Moselhi, O., 2013. Schedule compression using fuzzy set theory and contractors judgement. *Journal of information technology in construction*, 18(4), pp. 64-75.

Ankrah, N. A., and Proverbs, D., 2005. A framework for measuring construction project performance: overcoming key challenges of performance measurement. London, s.n., pp. 959-969.

Anon., n.d.

Anumba, C., Beatham, S., Hedgess, I., and Thorpe, T., 2004. KPIs: A critical appraisal of their use in construction. *Benchmarking: An international journal*, 11(1), pp. 93-117.

Aouad, G., Cooper, R., and kagioglou, M., 2001. Performance management in construction: A conceptual framework. *Construction management and economics*, 19(1), pp. 85-95.

Arditi, D., Cheung, S., and Shi, J., 2001. Construction delay computation method. *Journal of construction engineering and management*, 127(1), pp. 60-65.

Atkinson, R., 1999. Project management: cost, time and quality, two best guesses and a phenomenon, its time to accept other success criteria. *International journal of project management*, 17(6), pp. 337-342.

Bakry, I., Moselhi, O., and Zayed, T., 2014. Optimized acceleration of repetitive construction projects. *Automation in Construction*, Volume 39, pp. 145-151.

Chan A.P.C and Chan, A., 2004. Key performance indicators for measuring construction success. *Benchmarking: An international journal*, 11(2), pp. 203-221.

Chan, D. W., and Kumaraswamy, M. M., 2002. Compressing construction durations: Lessons learned from Hong Kong building projects. *International journal of project management*, 20(1), pp. 23-35.

Chang, C. K., Hanna, A. S., Lackney, J. A., and Sullivan, K. T., 2007. Quantifying the impact of schedule compression on labour for mechanical and sheet metal contractor. *Journal of construction engineering and management*, 133(4), pp. 287-296.

Eden, C., and Howick, S., 2001. The impact of disruption and delay when compressing large projects: going for incentives?. *Journal of operation research society*, Volume 52, pp. 26-34.

Gao, L., Song, L.-g., and Webb, C., 2015. Schedule compression impact on construction project safety. *Frontiers of engineering management*, Volume 2, pp. 344-350.

Gunatilake, S., and Theivendran, J., 2015. A study on the impacts of schedule compression techniques on construction project in Sri Lanka. Colombo, s.n., pp. 66-75.

Hanna, A., and Noyce, D., 1998. Planned and unplanned schedule compression: The impact on labour. *Construction management and economics*, 55(4).

- Hughes, S. W., Tippett, D. D., and Thomas, W. K., 2004. Measuring project success in the construction industry. *Engineering management journal*, 16(3), pp. 31-37.
- Junnonen, J.-M., and Kärnä, S., 2016. Benchmarking construction industry, company and project performance by participants' evaluation. *Benchmarking: An International Journal*, 23(7), pp. 2092-2108.
- Mansur, S., Mohamed, A., and Putra, C., 2003. Productivity assessment and schedule compression index (PASCI) for project planning. s.l., s.n., pp. 133-147.
- Mubarak, S. A., 2015. *Construction project scheduling and control*. 3rd ed. New Jersey: John Wiley & Sons.
- Ngacho, C., and Das, D., 2017. Critical success factors influencing the performance of development projects: an empirical study of constituency development fund projects in Kenya. *IIMB Management Review*.
- Pillai, A., Joshi, A., and Rao, K., 2002. Performance measurement of R&D projects in a multi-project, concurrent engineering environment. *International journal of project management*, Volume 20, pp. 165-177.
- Proverbs, D., and Xiao, H., 2003. Factors influencing contractor performance: An international investigation. *Engineering, construction and architectural management*, 10(5), pp. 322-332.
- Roofigari-esfahan, N., 2011. *Project schedule compression considering multi-objective decision environment*, s.l.: s.n.
- Ssemwogerere, K., 2011. A case for acceleration rather than extension of time on construction projects in Uganda. s.l., s.n., pp. 192-195.
- Uthpala, H., and Ramachandra, T., 2015. *Study on modern methods of construction used in Sri Lanka*. Kandy, s.n., pp. 155-162.
- Willar, D., 2017. Developing attributes for evaluating construction project-based performance. *The TQM Journal*, 29(2), pp. 369-384.

Samarawickrama, Sumanthri, et al (eds), 2018, "Sustainability for people - envisaging multi disciplinary solution": *Proceedings of the 11th International Conference of Faculty of Architecture Research Unit (FARU), University of Moratuwa, Sri Lanka, December 08, 2018* Galle pp. 107–115. ©

A FRAMEWORK TO IMPLEMENT DESIGN AND BUILT PRACTICES FOR GREEN AND ADAPTIVE REUSE OF EXISTING BUILDINGS

WIJESIRI W.M.M.¹, DEVAPRIYA K.A.K.² & RATHNASIRI H.W.T.P.³

^{1,2,3}Department of Building Economics, University of Moratuwa, Katubedda, Sri Lanka

¹*Madhuranga.wijesiri.wm@gmail.com*, ²*kakdevapriya@uom.lk*, ³*Stprathnasiri@gmail.com*

Abstract

Adaptive Reuse is the process to improve environmental, social and financial performance of buildings. Reuse of existing buildings, especially as a result of performance upgrades has been identified with a significant impact on the sustainability of built environment. Application of adaptive reuse with green building concept is known as difficult and lacks attention in the field of research. Further, the potential to implement Green Adaptive Reuse has become uncertain as the way of implementing specific design, build practices for green buildings is still unknown. Thus, this research is aimed at developing a framework to implement design and built practices for green adaptive reuse of existing buildings. A qualitative research approach was followed for this research with semi-structured interviews involving nine (09) local expert professionals and one (01) international expert professional. The findings were analyzed using content analysis method. Physical, Economics, Functional, Technological, Social, Legal and Political were identified as major design criteria, which related to green building practices. Further, the findings included with barriers and strategies for the implementation of green adaptive reuse for existing buildings. Considering the Sri Lankan context, this study developed a framework as a guide for the implementation of green adaptive reuse for existing buildings. Moreover, government involvement, conducting social awareness programmes, developing skilled professionals, empowering the regulations, provisions of tax concessions through government intervention were highlighted as strategies to mitigate barriers of green adaptive reuse. Finally, a framework was developed for the implementation of green adaptive reuse concept for existing buildings.

Keywords: *Adaptive Reuse- Green- Existing Buildings- Design and Built Practices- Barriers and Strategies*

1. Introduction

Reuse can be described as something special, unique and often expensive, and adaptation can mean rehabilitation, refurbishment or repair work, not necessarily involving the use of changes (Holyoake & Watt, 2002). Therefore, it can be reasonably justified that adaptation is a way to extend the life of a building and thus extend its sustainability through a combination of improvement and conversion (Lowe, 2004). Adaptive reuse can be identified as a process that improve the environmental, social and economic performance of any building (Langston, et al., 2008). Adaptive reuse the process of converting an obsolete or invalid project into a new project that can be used for different purposes, and it is the bypasses the wasteful demolition and reconstruction process (Department of Environment and Heritage [DEH], 2004). JL Architects (2015) points out that the key advantage of adaptive reuse is the opportunity to create a sustainable and uniquely designed structure that nods in history and current purposes.

The new building construction consumes many raw materials, energy and produces high carbon emissions. Buildings are more than 40% of global energy each year, producing one-third of global greenhouse gas emissions (GGE) (United Nations Environmental Programm [UNEP], 2009). Reuse of existing building stocks, especially due to performance upgrades, has been identified as having a significant impact on the sustainability of the built environment (Bromley, et al., 2005). According to Reed and Wilkinson (2008), there have been developments in the building design and construction phase that can reduce energy waste and reduce carbon dioxide (CO²) emissions, however, there are major problems with existing building stocks.

Most of existing stocks are in poor condition and operating efficiency is very low, such as high-energy consumption (Ma, et al., 2012). The adaptability of a building depends on its design, materials, form

and extent to which the building is suitable for its purpose (Remoy & Wilkinson, 2012). In the past decade, the concept of building adaptive reuse has become important, as work in public and private organizations requires more creative and flexible workplace design changes (Douglas, 2006).

According to the Myers and Wyatt (2004), Sustainable development raises the importance of buildings as economic, social and cultural capital and should not be wasted. As described by Getty Conservation Institute, Current research efforts are advocate the integration of green environmental design into the adaptive reuse of existing buildings (Getty Conservation Institute [GCI], 2011). Only a few places have been mentioned for about green adaptive reuse of buildings and their green design and built practices. Due to the limited research published on green adaptive reuse in existing buildings, particularly in terms of sustainability, the proposed review is expected to provide the basis for future research in this contemporary and controversial area.

The aim of this research was to implement design and built practices for green adaptive reuse of existing buildings in built environment. The objectives were identified as, (i) To identify the design and built practices for green adaptive reuse of existing buildings, (ii) To determine the barriers of design and built practices for green adaptive reuse of existing buildings, (iii) To investigate the strategies to implement design and built practices for the green adaptive reuse of existing buildings and (iv) Develop a framework to implement design and built practices for the green adaptive reuse of existing buildings.

2. Literature findings

2.1 CONCEPT GREEN ADAPTIVE REUSE OF EXISTING BUILDINGS

In an age of climate change, adaptive reuse is important to future because must maximize wealth and utility to minimize resources and environmental impacts (Gorgolewski, 2008). "Green adaptive reuse" is an effective way to extend the life of the facility and reduce the carbon footprint while helping to protect the value of important heritage that defining cultural development. The concepts of "Green Adaptation and Reuse", including the principles of green renovation of historic buildings and technology to improve performance while preserving heritage and cultural values (Langston , 2010). Through green adaptive reuse process of building, sustainability and climate change can be promoted by reducing CO₂ emissions (Bullen, 2007). However, this is an important strategy for adaptive reuse. Practitioners increasingly combine sustainable design with adaptive reuse of existing buildings to create a green adaptive reuse area (Thomsen & Van der Flier, 2006). Furthermore, further research and advocacy are needed to develop guideline and strategies increasing the green adaptive reuse of buildings.

2.2 DESIGN AND BUILT PRACTICES FOR GREEN ADAPTIVE REUSE OF EXISTING BUILDINGS

The architectural and structural integrity of the building must be maintained while adding modern features (Loonen, et al., 2001). In addition, it is necessary to check the settlement of the foundation and the adequacy of was carried new load conditions. The structural properties of building materials, including soil, must be tested. Retrofitting modern pipelines, HVAC systems, and electrical and communication systems requires sophisticated surgery on existing skin and skeletons in historic buildings (UNEP, 2009). Meeting modern regulatory requirements such as fire safety, safety and disability to reduce the historical appearance of buildings is a major challenge (Wilkinson, et al., 2012). The removal and safe disposal of toxic substances is a strict requirement. All of these barriers are best handled by the careful planning of architects, engineers and builders before beginning the implementation of adaptive reuse projects (Hein & Houck, 2008). Designing a building for adaptability can reduce the generation of significant construction waste during building renovation (Adeyemi, et al., 2014).

2.3 BARRIERS OF GREEN ADAPTIVE REUSE OF EXISTING BUILDINGS

One challenge that architects and engineers face when designing for adaptive reuse is designing a high performance building while maintaining the independence of the systems and features that enhance adaptability, such as redundancy, robustness, and ease of access, repair and replacement (Saleh & Chini, 2009). Shipley, Utz, & Parson (2006) suggested that this technical challenge requires a wide range of renovation and refurbishment technologies. In addition, they are almost always accompanied

by higher cost challenges. The exhibits harmoniously restored all the structures of the building and restored them to their original freshness (Mathieu, 1999). Furthermore, Table 1 is presented three (03) main barriers according to the Haritos & Lam (2010).

Table 1 - Main Barriers

Main Barriers	Description
Cost	Construction elements and materials are usually not designed to facilitate their complete removal, which makes them difficult and costly to salvage
Safety issues	They are not been considered easy to remove in their design to get main elements, especially by trying to remove the tertiary and secondary elements and then disconnecting them often leads to high risk
Integrity issues	The fitness for purpose (or reuse) of construction elements and materials may be questioned as their strength and integrity may have been compromised from adverse loading effects, during their history of operation, or as a result of the removal process itself.

Source (adapted from Haritos & Lam, 2010)

3. Research methodology

According to the Taylor (2005), the advantages of qualitative approach as could focus on specific set of people, in depth study on broad topics, offer greater latitude in selecting topics and representing the views and perspectives of the people. Therefore, qualitative approach was selected to explore the concept vigorously. Because of the lack of applicability of the green adaptive reuse concept in Sri Lankan build environment, drawing a large sample of respondents for data collection was constrained. Hence, qualitative approach was undertaken for this research. Within the research in concern, expert interviews were taken as the data collection sources (Kothari, 2004). Semi-structured interviews were selected for this research because it elicits more elaborate and purposeful answers from the respondents to the research questions. These expert interviews were used to accomplish the set of whole objectives of this research. In Sri Lankan green adaptive reuse of building context, expert professionals with both practical and theoretical knowledge were limited. Ten (10) professionals, who were experienced of adaptive reuse, green building concept and design and built practices in construction industry.

Content analysis is the procedure for the categorization of verbal or behavioral data for the purpose of classification, summarization and tabulation (Creswell & Creswell, 2018). This refers to compiling and interpreting of collected data based on the research techniques used and form of data collected. For that, study was carried out by conducting the semi-structured interviews. Therefore, this research, content analysis was taken as the data analysis technique. The QSR NVivo 12 software is to be used for the data analysis process.

4. Research findings and analysis

4.1 DESIGN AND BUILT PRACTICES FOR GREEN ADAPTIVE REUSE OF EXISTING BUILDING

Design and built practices for Green Adaptive Reuse of existing buildings are discussed, while reviewing seven (07) design criteria, which were identified from literature. In literature review, Design criteria have to be applied on the reused projects, thus could be implemented several points (Naguib, 2015). Those are, Long Life (Physical), Location (Economics), Loose Fit (Functional), Low Energy (Technical), Sense of Place (Social), Quality Standard (Legal) and Context (Political). The design and built practices identified under each design criteria was structured and supported by "NVivo 12" data analysis software.

Table 2 - Design and Built practices in green adaptive reuse of existing buildings

Design and Built practices in green adaptive reuse of existing buildings
1. Long Life (Physical)
Consider Easy to maintenance
Consider the various geometries of the building before doing the design and innovation
Define building capabilities to save operational resources
Identified the structural integrity of the building (Purpose identified, brief identified, volume and safety identified)
Identify the climate changes

Identify the differential settlement and substrata movements
Indigenous workmen and quality craftsmanship
Look building's history for inspiration
Preserve the structure of historic building
Resuscitating the structural masonry shell and infusing it with a modern core
Reuse the existing materials
Select the durable materials and assets
Using eco-friendly materials
Using green resources and materials (Eg: Green Roof, Walls)
Using recyclable materials
2. Location (Economics)
Consider the built area, spatial proportion and enclosure, site access, parking and other facilities
Consider the location and distance of the urban or major city
Consider the planning constraints
Consider the transport and other infrastructure facilities in area
Design the plot size according to the landscape
Land in use highest and best
Minimum damage to the tree
Using Geothermal heating and cooling
Walkable distance to many public uses or services (Centrality)
3. Loose Fit (Functional)
Design the building as a flexibility
Design the space, as a divisibility, elasticity, multi functionality
Design the structural grid as the ideal and economic limit of the span and fully interchangeable
Design the vertical circulation
Space capabilities are changed according to the new requirements
Using multifunctional furniture
4. Low Energy (Technical)
Design the indoor and outdoor courtyard – open area, gardens
Design the thermal mass, sunshades and automated blinds
Dismantled to open the building to allow it to naturally daylight and improve air circulation
Ensure cross ventilation
Equitable green space allocation
Increase the ambient air intake
Installation the BMS system for the building services
Solar installation for getting the energy
The rainwater retention system collects and stores as much rainwater as possible
Using external stone paving
Using the double screen windows for western side
Using the glazing for sunlight glare control and regulate internal temperature.
Using the unique cooling system
When the light is too high or too low, automatic control and artificial lighting are ready to enter
5. Sense of Place (Social)
Design the building , according to the local and social communities
Design the building according to the human scale, then consider the anthropometrics.
Indigenous materials to conserve authenticity
Networking parks
Preservation of natural landmarks (Eg; large trees, sacred trees, rocks)
Prevent social and cultural attributes and value
Protect the historical aesthetic appearance of the buildings
Provides comfort and convenient facilities
Using the reusable materials with original appearance of the historic building
Visual coherence and organization of the built environment using the landscape
6. Quality Standard (Legal)
Check the air quality
Design hygiene and a clean environment
EMP's (Environmental Management Practices) implemented during the project based on significant environmental impact anticipated
Green building Comprehensive Assessment System for Built Environment Efficiency (CASBEE), SL – Green building Council , UK - LEEDS
Provision for high standard workmanship
Provisions for fire safety
To control the noise level, using the sound insulation materials
Using safety regulations
Using the environmental performance measures
Using the hazard and risk management plan
Using the non-hazardous materials

7. Context (Political)

Consider the Ecological Footprint
 Follow the government and archaeological department Guidelines , principles and legislation
 Get the community interest and participation
 Green zoning (Environment conservation and protection zones)
 Want the urban master plan.

4.2 BARRIERS OF GREEN ADAPTIVE REUSE OF EXISTING BUILDINGS

The converting Adaptive Reuse Buildings with Green Building Status is seen as a difficult task and can be identified as an area that lacks attention because their common barriers. According to the interviewees, such barriers can be identified in Green Adaptive Reuse of Existing Buildings. In the literature review, three (3) barriers were mainly identified including, cost, safety issues and integrity issues. In addition, interviewees discussed the barriers of Design and Built Practices for Green Adaptive Reuse of Existing Building in seven (7) categories. The Figure 4.9 illustrated the barriers of the design and built practices for Green Adaptive Reuse of Existing Buildings under each design criteria, which were structured and supported by “NVivo 12” data analysis software.

Table 3 - Barriers of Green Adaptive Reuse of Existing Buildings

Barriers of Green Adaptive Reuse of Existing Buildings
1. Long Life (Physical)
Cannot easy to disassembly
Lack of awareness
Lack of flagship project
Lack of motivation to adapt green
Lack of old materials (Eg: tiles or brick)
Over structures
Termite breakage
The facility has significant embedded physical life (or residual value) and structural integrity
The frame of doors and windows cannot be find in market
Time allocation problems
2. Location (Economics)
Financial risk
High opportunity cost
High repair and maintenance cost
3. Loose Fit (Functional)
Fault building design
No side or back yard
Outdated of equipment
Poorly arranged floor plan
Raised the leaks , Damage the building (Eg: with plant growth and water seepage)
4. Low Energy (Technological)
Inadequate space available to accommodate modern building services.
Inflexibility to accommodate new information technology
Limited local technical – know- how
No structural drawings and mechanical and electrical drawings
5. Sense of Place (Social)
An expensive building in a neighborhood where a new uses for the industrial plant which cause a loss in property values because no one wants to in that building
Lack of knowledge about the GARB concept
The communities against changing the heritage and culture of the property
The existing function or purpose of the facility has become inappropriate due to changing social expectations and/or market needs
6. Quality Standard (Legal)
Over protected
Regulation barriers
Unpredictable and difficult to predict due to lack of information about the future development and confidentiality of government policies
7. Context (political)
Archeological building protected
High control over historical – building reuse (modification)
National building protected

4.3 STRATEGIES TO IMPLEMENT DESIGN AND BUILT PRACTICES FOR GREEN ADAPTIVE REUSE OF EXISTING BUILDINGS

Barriers faced by the Green Adaptive Reuse projects throughout the design criteria (Physical, Economics, Functional, Technological, Social, Legal and political) were identified via the semi structured interviews conducted with the experts of Adaptive Reuse Buildings (Refer Section 4.2). Strategies adopted to overcome each barrier of design and built practices of green adaptive reuse of existing buildings were elicited from the experts during the interviews and literature review.

Table 4 - Barriers and Strategies

Barriers	Strategies
Lack of old materials	<ul style="list-style-type: none"> • Proper management system
Lack of awareness	<ul style="list-style-type: none"> • Conducting social awareness programmes • Developing skilled professionals • Provided training programme for the workers
Time allocation problems	<ul style="list-style-type: none"> • Implementation the time action plan • Implementation the time line
Lack of flagship project	<ul style="list-style-type: none"> • Management support and commitment • Conducting workshop
Lack of motivation to adapt green	<ul style="list-style-type: none"> • Conducting the awareness programme • Provided training programme
Financial risk	<ul style="list-style-type: none"> • Create a policy and use it consistency
High repair and maintenance cost	<ul style="list-style-type: none"> • Simplify the procedure • Optimize the equipment • Review training practices • Prepared maintenance schedule • Right technology and get warranties and insurance
Fault building design	<ul style="list-style-type: none"> • Assigned professional with proper skills and experience about Green Adaptive Reuse Building concept
Over protected	<ul style="list-style-type: none"> • Government involvement • Provisions of tax concessions through government intervention • Empowering the regulations
Limited local technical – know-how	<ul style="list-style-type: none"> • Using new technology

Among the identified barriers, this considers critical barriers such as barriers which are repeated in different design criteria and highlighted the barriers by experts. Table 4 presents the critical barriers of Green Adaptive Reuse Building projects along with the strategies. Strategies adopted to overcome the critical barriers faced by Green Adaptive Reuse Building projects.

5. Conclusion

The research findings and their entire outcomes can be achieved research objectives and finally research aim. The findings of the research, indicate a new concept to the Sri Lanka construction industry and society. The less awareness of the community and less government involvement is the major problems because of the undeveloped the GARB concept in the construction industry. Overcome the barriers of the GARB concept would be making the proper design and built practices for Green

Adaptive Reuse of Existing Buildings. Further, the findings included with barriers and strategies for the implementation of green adaptive reuse for existing buildings. Considering the Sri Lankan context, this study developed a framework (Refer Annexure I) as a guide for the implementation of green adaptive reuse for existing buildings.

6. Recommendations

In this research identified Design and Built Practices for Green Adaptive Reuse of Existing Buildings. In Sri Lankan construction industry, have not the framework for Adaptive Reuse or Green Adaptive Reuse. Professional in construction industry wants to proper framework for an adapted green concept for the adaptive reuse of existing buildings. Through the research, it was recommended to consider suggestion strategies. Government involvement, conducting social awareness programmes, developing skilled professionals, empowering the regulations, provisions of tax concessions through government intervention were highlighted as recommended to green adaptive reuse of existing buildings.

The research exposed scenarios pertaining to the Green Adaptive Reuse of existing buildings within design and built practices. Nevertheless, the Green Adaptive Reuse is a subject, which is developed with the time, and there are immense of scenarios yet to be discussed and exposed. These proposals are recommended as ideal proposals for further researches on Green Adaptive Reuse of existing buildings can be performed with the necessary adjustments.

- Test the validity of the Design and Built Practices for Green Adaptive Reuse of existing building developed framework to Construction industry in Sri Lanka
- Cost Benefit Analysis (CBA) of significant Green Adaptively Reused of existing building projects
- Implementing the assessment process for Green Adaptive Reuse of existing buildings
- Facilities Management (FM) role in Green Adaptive Reuse of existing buildings

7. Acknowledgement

I would like to convey my heartfelt gratitude to my inspirational dissertation supervisor and my assistant supervisor. I express my heartfelt gratitude to my beloved family members, my batch mates and senior sisters and brothers, for willingly giving me their utmost support, advice and continuously motivating me to carry out the work successfully.

8. References

- Haritos, N. & Lam, N. T. K., 2010. *Reuse-Issues and Challenges in Structural Engineering Applications*. Australia, University of Melbourne, pp. 267-273.
- Adeyemi, A., Martin, D. & Kasim, R., 2014. *Application of Lean thinking to the built environment in developing nations for sustainability*. Bauchi, Federal Polytechnic.
- Bromley, R. D. F., Tallon, A. R. & Thomas, C. J., 2005. City Centre Regeneration through Residential Development: Contributing to Sustainability. *Urban Studies*, 42(13), pp. 2407-2429.
- Bullen, P., 2007. Adaptive reuse and sustainability of commercial buildings. *Facilities*, 25(1/2), pp. 20-31.
- Creswell, J. W. & Creswell, J. D., 2018. *Research design : qualitative, quantitative & mixed methods approaches*. Los Angeles: SAGE publishing.
- Department of Environment and Heritage [DEH], 2004. Department of Environment and Heritage. *Adaptive Reuse*.
- Getty Conservation Institute [GCI], 2011. *Sustainability and heritage in a world of change, professionals forum held at Getty Centre*. [Online] Available at: http://www.getty.edu/conservation/public_programs/sustain. [Accessed 12 11 2017].
- Gorgolewski, M., 2008. Designing with reused building components: some challenges. *Building Research & Information*, 28 5, 36(2), pp. 175-188.
- Hein, M. F. & Houck, K. D., 2008. Construction Challenges of Adaptive Reuse of Historical Buildings in Europe. *International Journal of Construction Education and Research*, 4(2), pp. 115-131.
- Holyoake, K. & Watt, D., 2002. *The sustainable reuse of historic urban industrial buildings: interim results and discussion*. [Online] Available at: <http://www.rics-foundation.org/index.html>
- JL Architects, 2015. *Commercial, Multi-Family, Sustainability*. [Online] Available at: <https://www.listerarch.com/advantages-of-adaptive-reuse/>
- Kothari, C., 2004. *Research Methodology Methods & Techniques*. 2 ed. Jaipur : New Age International Publishers.

- Langston , C., 2010. Green Adaptive Reuse: Issues and Strategies for the Built Environment. *Modeling Risk Management in Sustainable Construction*, pp. 199-209.
- Langston, C., Wong, F. K., Hui, E. C. & Shen, L.-Y., 2008. Strategic assessment of building adaptive reuse opportunities in Hong Kong. *Building and Environment*, 43(10), pp. 1709-1718.
- Loonen, R., Favoino, F., Hensen, J. & Overend, M., 2001. Review of current status, requirements and opportunities for building performance simulation of adaptive facades. *Journal of Building Performance Simulation*, 7 March, 10(2), pp. 205-223.
- Lowe, R., 2004. 2004. *Lessons from climate change: a response to the commentaries*, 32(1), pp. 75-78.
- Mathieu, C., 1999. *Orsay*. Paris: Editions Scala.
- Ma, Z., Cooper, P., Daly, D. & Ledo, L., 2012. Existing building retrofits: Methodology and state-of-the-art. *Energy and Buildings* 55, pp. 889-902.
- Myers, D. & Wyatt, P., 2004. Rethinking urban capacity: identifying and appraising vacant buildings. *Building Research & Information*, 32(4), pp. 285-292.
- Naguib, I., 2015. *Green Adaptive Reuse of Historic Buildings A case study: Wekalet El-Lamoun, Alexandria, Egypt*. Dubai, s.n., pp. 113-119.
- Reed, R. G. & Wilkinson, S. J., 2008. *The business case for incorporating sustainability in office buildings : the adaptive reuse of existing buildings*. Kaula Lumpur, Malaysia, Pacific Rim Real Estate Society, pp. 1-18.
- Remoy , H. & Wilkinson, S., 2012. Office building conversion and sustainable adaptation: a comparative study. *Property Management*, 30(3), pp. 218-231.
- Saleh, T. & Chini, A., 2009. *Building green via design for deconstruction and adaptive reuse*, Florida: University of Florida.
- Shiple, R., Utz, S. & Parsons, M., 2006. Does Adaptive Reuse Pay? A Study of the Business of Building Renovation in Ontario, Canada. *International Journal of Heritage Studies*, November, 12(6), pp. 505-520.
- Taylor, G., 2005. *Integrating Quantitative and Qualitative Methods in Research*. [Online] Available at: https://books.google.lk/books/about/Integrating_Quantitative_and_Qualitative.html?id=l7WJTcbxcmQC&redir_esc=y [Accessed 27 April 2018].
- Thomsen, A. & Van der Flier, C., 2006. *Life cycle of dwellings: A conceptual model based on Dutch practice*. Naples, Luciano Editore.
- United Nations Environmental Programm [UNEP], 2009. Buildings and climate change: Summary for decision - makers. *United Nations Environmental Programme, Sustainable Buildings and Climate Initiative*, pp. 1 - 62.
- Wilkinson, P., Glockling, J., Bouchlaghem, D. & Ruikar, K., 2012. Using business impact analyses to enhance resilient fire engineering building design. *Architectural Engineering and Design Management*, 31 October, 9(4), pp. 229-249.

Annexure I - Framework for Design and Built Practices for Green Adaptive Reuse of existing buildings

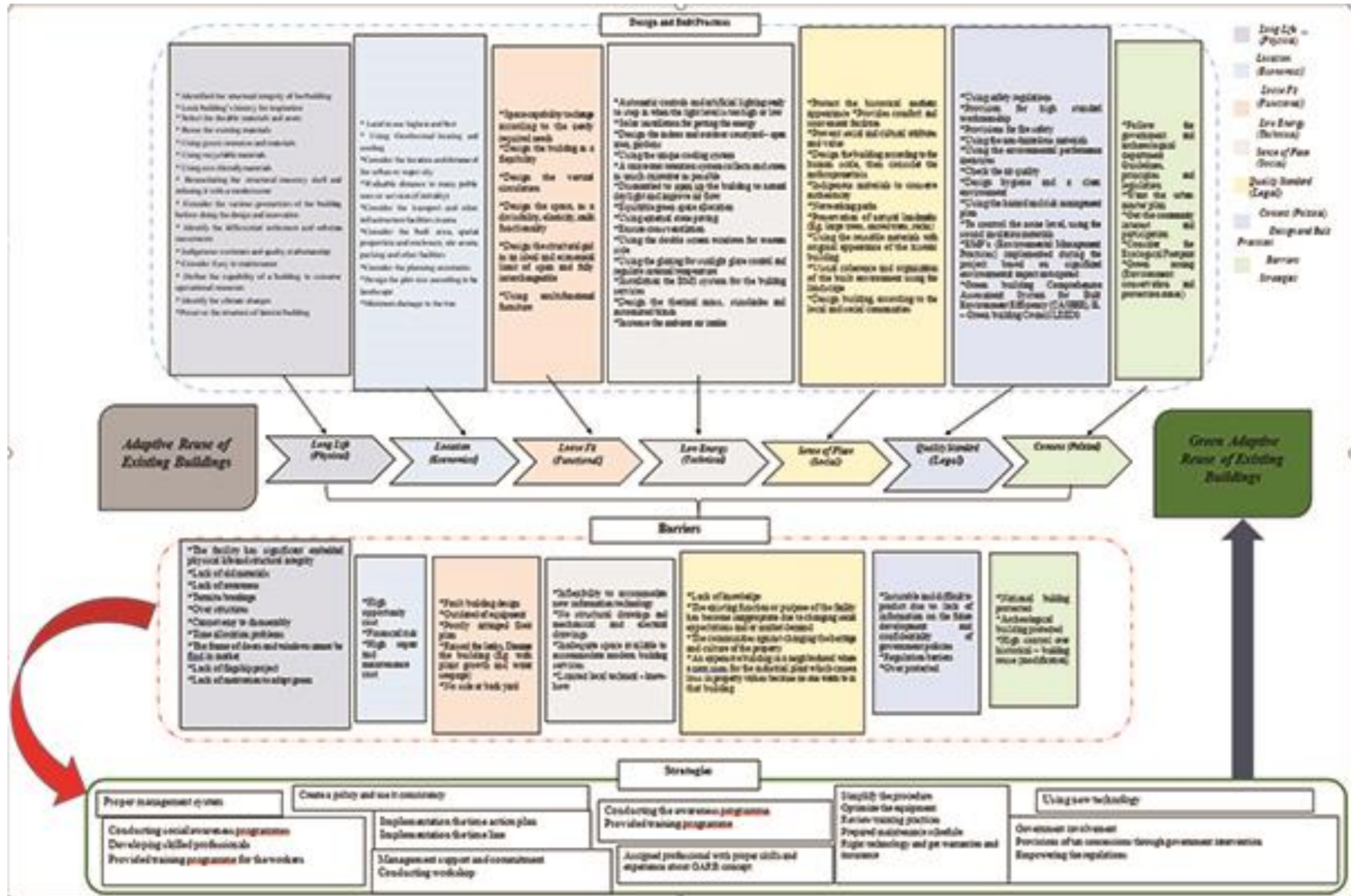

Samarawickrama, Sumanthri, et al (eds), 2018, "Sustainability for people - envisaging multi disciplinary solution": *Proceedings of the 11th International Conference of Faculty of Architecture Research Unit (FARU), University of Moratuwa, Sri Lanka, December 08, 2018* Galle pp. 116–122. ©

THE ROLE OF FACILITIES MANAGEMENT IN LOGISTICS AND WAREHOUSING IN SRI LANKA

RATNAYAKE. A¹, ABEYSINGHE. N.S.D² & ANDARAWEEERA. A.K³

¹Hayleys Advantis Limited, Colombo, Sri Lanka, ^{2,3} Edward Constantine Private Limited, Colombo, Sri Lanka

¹asanka.ratnayake@hayleysadvantis.com, ²nelushi.abeyasinghe@gmail.com, ³andaraweera@outlook.com

Abstract

Facilities Management (FM) is frequently described as an integrated approach to operate, maintain, improve and adapt the buildings and infrastructure of an organization to create an environment that strongly supports primary objectives of that organization. The FM discipline emerged out of practice because of a clear need to focus on elaborate facilities, which critically support the activities of most of today's organizations. Business organizations consider supply chain and logistics performance as important elements for the achievement of competitive advantages. In this context, FM plays a significant role in managing and operating diverse types of constructed facilities for logistics and warehousing. In fact, it assures the successful management of the whole warehousing system, which includes both, building, utilities, and material handling equipment. However, limited literature is available in this area to set the importance of FM within this context, and very little analysis has been carried out to understand the importance of FM to create the conditions for improved performance of logistic and warehousing. Therefore, this study aims to provides a comprehensive review of the FM function in the logistics and warehousing arena in Sri Lanka which is identified as a potential logistics hub in South-East Asia and Indian sub-continent region.

Keywords: *Facilities Management; Facilities; Logistics; Sri Lanka; Warehousing*

1. Introduction

Facilities Management (FM) has been recognized as a crucial service for business organizations during the recent past decades (Scupola, 2012). FM is frequently described as an integrated approach to operate, maintain, improve and adapt the buildings and infrastructure of an organization in order to create an environment that strongly supports primary objectives of that organization. FM functions help to enable successful business activities of an organization and further it helps to achieve its' employees' expectations related to day to day operations. (Lavy et al., 2010). As per (Tucker and Pitt, 2009), the term FM can be referred to integration and alignment of the non-core services which are required to operate and maintain a business. The crucial factor behind the increasing attention of FM concept is mainly due to its ability to save costs and generate efficiencies.

The discipline of FM is being effectively being practiced even within various facilities related to logistics and warehousing. The key focus of FM within these types of facilities is to operate and maintain them throughout the building life-cycle. Even though the FM concept is properly recognized as a benefiting factor for logistics and warehousing industry in overseas countries, the importance has not been recognized within the local context.

FM scope covers the full service of the warehousing system, which includes building, utilities, and material handling equipment. Despite increasing recognized importance of FM as an integrated component of business operations, most companies in the logistics and warehousing business in Sri Lanka complain about the rising cost of maintenance of industrial and logistic facilities. Management of such companies frequently pursue to cut operation and maintenance spending by reducing repair interventions to a minimum and by delaying preventive maintenance actions, leading to a cascade of extra costs in the medium and long term (De Marco et al., 2010).

There is very little study has been conducted to identify the role of the FM function in the fields of logistics and warehousing. Within the context of developing Sri Lanka as a logistic hub, it is important

to conduct an analysis to understand the importance of FM to create the conditions for improved performance of logistic businesses. Therefore, to address this research gap, this paper highlights the relationship of the FM function in the logistics and warehousing arena.

To unveil the connection between the both FM and logistics business in the Sri Lankan context, the paper is structured as follows. Relevant literature review is demonstrated under the main topics; 'Sri Lanka as a Logistics Hub'; 'Performance measurement in logistics operations'; 'Performance measurement in FM'; 'Maintenance of warehouses' and 'Outsourced FM contracts'. Finally, implications and conclusions are drawn together with future research directions.

2. Sri Lanka as a Logistics Hub

Logistics industry has evolved over years by re-engineering organizational cost structures to become more competitive and face the competition arising due to globalization. The focus in 1970's was towards 'distribution management' which evolved to integrated logistics management in 1980's and then to supply chain management in the 1990's. The three-decade evolution was from market share of customer in 1970's to share of customer in 1990's through the focus on creating operational efficiency of the organizations.

The annual global logistics cost is estimated to be USD 3.5 trillion. The annual logistics cost of any country is estimated to be with 9% - 20% of its gross domestic production. This explains why the nations and organizations are increasingly focusing on improving the efficiency of their logistics operations.

Today the logistics industry is faced with the challenges of pricing pressure, high cost of operations, low return on investment and pressure from customers to continuously improve efficiency. In this backdrop the role of the service providers have become very important to complete the supply chain integration. With South-East Asia becoming a major player in the global economy the logistics industry is seen to be growing at a very fast rate in this region when compared to the other regions worldwide. As a region, East-Asia Pacific tops the list in Logistics Performance Index (LPI) that includes Singapore, Japan and Hong Kong. With the growth of business in South East Asia, organizations are looking to expand their business operations to the region. Further, Sri Lanka is ideally being located between two of the fastest growing economies in the world; India and China, it has the unique advantage of becoming a regional logistics hub in the South-East Asia and the Indian sub-continent.

Sri Lanka possesses a natural advantage of geographically being strategically located in South-East Asia and the Indian subcontinent. This geographical location has given the country a natural advantage which only few other nations has the privilege of enjoying. In the aviation industry Sri Lanka is located in the shortest point of the then called kangaroo route; in maritime Sri Lanka is just 10 - 12 nautical miles deviation from the main East West maritime route. Sri Lanka generally does not face any major natural disasters such as cyclones, earth quakes, tornadoes or even labour disputes that cause long term shut down of country's logistics operations. Therefore, logistics can play an important role in Sri Lanka's competitiveness as a business location and that will add more industrial value to the economy.

With international trade expected to grow rapidly in the coming decade, led by economic expansion of BRIC – Brazil, Russia, India and China, air and sea ports located closer to those markets are expected to face capacity issues. This situation creates an opportunity for new air and sea ports to develop in the region and some of those upcoming air and sea ports to even emerge as hubs. These opportunities become even greater when the geographical sites are in the main air and sea routes. In addition, the expansion of BRIC economies is likely to change the origin and destination of manufacturing and consumption patterns of goods and services.

A regional logistics hub provides its customers a one stop centre for obtaining logistics services including customer's deliveries when required, warehouse with or without free zone facilities, integrated with supply chain and transparency through using of information communication technology. It also provides exporters and importers with facilities to handle multi country consolidations at a single location on duty free basis. It will also provide other value added facilities such as cool, cold and chilled room facilities, vendor managed inventory services, post-delivery

inspections facilities, yard management, sterilization, fumigation, inventory management, haulage, distribution services, freight and customs brokering services. Given this back ground, there are greater opportunities for establishing Sri Lanka as a logistics hub in South-East Asia and Indian sub-continent region.

However, according to the Logistics Performance Index (LPI), Sri Lanka is ranked at 89th position in the world ranking which is way below compared to other regional countries. It is also noted that Sri Lanka is not ranked within the top 10 amongst the middle-income earning country category falling below India and Pakistan. Countries that top the LPI rankings are major global transport and logistics hubs, like Singapore, or the base of a strong logistics service industry, such as Switzerland.

Therefore, in order to be successful as a logistics hub, Sri Lanka has to monitor and improve its logistics operations performance while formulating strategies to keep distinctive competitiveness advantage in such a changing market environment.

3. Logistics operations performance

Over the last decade, the role of logistics in most businesses has increased in both scope and strategic importance. The Council of Supply Chain Management Professionals (2007) define logistics management as “that part of supply chain management that plans, implements, and controls the efficient, effective forward and reverse flow and storage of goods, services and related information between the point of origin and the point of consumption in order to meet customers’ requirements”. Initiatives such as supply chain integration, quick response and just-in-time, inventory control have revolutionized not only the way companies manage their logistics activities, but also how they run their entire business. The highly competitive environment along with customers’ demand has forced companies to continuously evaluate, improve and re-engineer their logistics operations (Gotzamani et al., 2010). Companies have started to consider supply chain and logistics performance important elements for the achievement of competitive advantages (Harrison and New, 2002).

As per Wong and Karia, (2010), Logistic Service Providers (LSPs) have to measure their performance based on five strategic resources; physical, human, information, knowledge and relational resources to achieve competitive advantage. ‘Physical resources’ include tangible assets required to perform logistic tasks. Therefore, building structures and associated building engineering systems can be considered as ‘Physical resources’. Human resources are referred to as workforces who are skilful and experienced in performing logistics tasks and building up and maintaining customer relationship. Knowledge resources are the abilities to gaining access to rare resources and relational resources are meant as the abilities to build up long-term working relationship with key suppliers and customers.

Therefore, it is logical to state that the performance of the built environment and the operators and occupants associated in the logistics and warehousing business decides the performance of the logistics operations in any given country. In a broader aspect, improved performance of the People, Processes and Places associated in the logistics business could enhance the performance of the logistics industry at national level.

The International Facility Management Association (IFMA) defines FM as a profession that encompasses multiple disciplines to ensure functionality of the built environment by integrating people, place, and processes. This is everything from buildings and parking lots, to parks and utility lines, and they all need to be managed effectively. All facilities must be managed in order for them to operate according to their purpose.

4. Performance measurement in facility management

FM services were first provided in the 1960s in the USA, and they were fully developed in 1970s; but it was only in the 1980s that such FM market developed in Europe (Salaris, 2002). The FM function is mainly associated with building facilities and auxiliary services; it includes activities such as building maintenance, utilities management, gardening, surveillance, cleaning, etc. (Ancarani and Capaldo, 2005). The importance of measuring the performance of the FM function becomes evident because

costs associated with maintenance represent the largest ones for an organization after the cost of personnel and the cost of the production assets. This proves further the need for FM to be part of the business model.

Key Performance Indicators (KPIs) in FM are associated with cost of operations, maintaining and running a facility, revenue generated space usage and management, environmental, health and safety issues (Enoma and Allen, 2007). Some of the most important KPIs pertaining to FM are: client satisfaction, cost effectiveness, response time, service reliability, health safety, environmental compliance, staff commitment, client-service provider relationship, and information and technology application.

Hinks and McNay (1999), conducted a survey on the most important KPIs that should be considered in the different performance dimensions, namely: equipment provided to meet business needs, correction of faults, management of maintenance, reliability, effectiveness of helpdesk services, and standard of cleaning. Lavy et al. (2010) propose a list of KPIs classified under the following categories: financial, physical, functional, and survey based. They state that a strong FM approach provides needed support to the organization's mission, the realization of future facility requirements, greater cost efficiency, and the ability to anticipate results of current management decisions. On the contrary, poor FM could result in inadequate facilities to support functioning, not contributing to the organization's mission, cost inefficiencies, and unavailability of the facility for future needs.

Maintenance of physical assets is one of the key function of FM. Performance of the Maintenance Management executed by the FM teams directly affects the overall performance of the logistics business. Warehouse maintenance is one of the key area falls under the FM division in the logistics and warehouses industry.

5. Warehouse maintenance

The scope of warehouse operations in terms of location, size, and type of equipment addresses whether the maintenance plan has its own in-house maintenance, or it depends more on contract services. Regardless of the source of repair, two responsibilities of warehouse maintenance must be achieved: safe and reliable operations of material handling equipment and maintenance of facilities, grounds, utilities, plumbing, heating, air conditioning, security system, fire protection, etc. (Smith and Tomkins, 1998).

Maintenance of built assets is often considered as a cost burden (Sherwin, 2000) and organizations are reluctant to spend, aiming at preserving the condition of their assets (Chew et al., 2004). Maintenance should be considered not only as a mere source of cost, but rather as a way for potential gain (Taillander et al., 2011). Therefore, FM professionals should consider the business implications of their actions before large maintenance programs are designed and carried out. Moreover, it is possible to monitor the impact of any action against key business drivers through feedback mechanisms (Jones and Sharp, 2007). By identifying the true strategic goals of maintenance and by implementing a well-formulated strategy, companies can optimize the return on investment of their maintenance expenditure (Salonen and Bengtsson, 2011). The measurement of maintenance performance appears to be very important and tracking the performance of maintenance operations should be a key management issue.

As a measure of improving the performance of maintenance operations of built assets, outsourcing FM function is popular among other countries.

6. Outsourcing Facility Management

Organizations have been increasingly turning to outsourcing in an attempt to enhance their competitiveness, increase profitability, and refocus on their core business (Burdon and Bhalla, 2005). Outsourcing is often seen as a critical business capability that enhances company's overall profitability. It allows managers to leverage resources and capability by concentrating on core competences that

create value for the company's customers (Yoon and Naadimuthu, 1994). As a matter of fact, logistics companies usually perform a mix of in-house repair and contract maintenance on their physical assets. Some maintenance activities are carried out by the warehouse staff, others are serviced by a supplier, especially in case of actions requiring equipment or skills that the plant personnel do not have. The way maintenance contracts are managed often depends on customary practice, corporate culture, and available human resources of the management team (Lai and Yik, 2007).

Many organizations, both in the public and private sectors, are increasingly outsourcing their asset maintenance jobs. FM services are usually long term and involve frequent contacts between supplier front-line staff and client end-user. This is especially applicable to long life equipment maintenance contracts (Datta and Roy, 2010). Contract design in FM varies considerably depending on the contracting parties' scope of the contract and type of relationship. A complete FM contract comprises numerous documents that specify responsibilities, KPIs and compensation principles (Kadefors, 2008). Al-Turki (2011) underlines the potential benefits of outsourcing maintenance activities such as reduced total system costs, better and faster work done, exposure to outside specialists, greater flexibility to adopt new technologies, and more focus on strategic asset management issues.

7. Critical analysis and future research directions

The analysis of the presented literature shows that FM has been considered as a way of managing cost efficiency. FM can bring value towards organizational effectiveness, through management and the improvement of physical assets and related services (Noor and Pitt, 2009). Effectively planned FM services can create significant business returns in the context of logistics business. As competition intensifies, and as change accelerates, many leading organizations are re-evaluating the contribution that FM makes to business success (Goyal and Pitt, 2007). Firms are realizing that there is a critical need for proper maintenance of facilities and assets (Meulen et al., 2008). Industrial plants and equipment are becoming technologically more advanced, and at the same time more complex and difficult to control. In addition, just in time, lean and agile manufacturing and logistics, and the use of automated storage and retrieval systems have made logistics assets increasingly vulnerable to risks and susceptible to diverse consequential effects due to breakdown (Holberg, 2001).

Moreover, with the growing dependence on technologies for most of logistics business operations, it is important to develop appropriate maintainability and reliability strategies to ensure that these organizations can deliver high quality and dependable services to their customers (Madu, 2000). FM should be included and positioned as a strategic support function and FM strategies should be aligned with the core activities of logistics service provider organizations. Goyal and Pitt (2007) argue that the relationship between organizational strategic (core business) and operational (non-core business) activities is vital in FM. FM needs to be recognized at the boardroom level. Hence, to be effective maintenance actions should be consistent with business strategy; in this way, it can be more proactive in contributing to the competitive advantage of a logistics companies (Pintelon et al., 2006).

Alsyouf (2006) states that at least 14 percent of potential improvements on the return on investment (ROI) are directly related to the contribution of the maintenance function to lost profits. Similarly, Salonen and Bengtsson (2011) show that the awareness of maintenance as a driver of the company's profitability increment. In particular, many companies have decreased the downtime due to corrective maintenance, which is more expensive than the time used for preventive maintenance. In this context, Blanchard (2004) demonstrates that a large percentage (e.g. 70 percent for some systems) of the total life cycle cost for a given system is due to operating and maintenance activities.

De Marco and Mangano (2011) prove that a few factors associated with the operational characteristics of the logistics business have a significant impact in improving the logistics service level. In addition, maintenance cost has an influence on the logistics service level performance. Thus, it is crucial to maintain both building components and logistics equipment to avoid expensive and ineffective managerial practices. These first results underline the importance of maintenance for the logistics service level performance. They support the notion that increased investment to preserve maintenance

status of the building and service components of warehouses is very likely to lead to improved performances of the logistics service level.

8. Conclusion

The aim of FM is the improvement of the effectiveness and efficiency of physical assets and workplace to contribute to enhancing operational business performance. In this context, improved logistics performance via FM and maintenance services is a significant factor to achieve continued competitive advantage. The logistics industry is aware of the role of maintenance in improving the reliability of systems and improving performance of the organizations. Nevertheless, there is a need to spend and invest more in maintenance, since the status and the role of maintenance are not highly recognized.

Appropriate strategies for FM can generate profits and can be an important source of competitive advantage is growing (Sherwin, 2000). Therefore, maintenance is playing a role on the strategic operational planning process: it is not only responsible for the reliability and the safety of the assets, but it can also fulfill environmental requirements.

Sri Lanka is ideally located in the growing Asia – Europe, Asia – North America trade lanes and this provides enormous opportunities for the country to position herself as a regional logistics hub and to gain a fair share of the logistics trade moving via this region. The regional logistics hub will also enable manufacturers, importers and exporters to consolidate multi-country warehouses in a single location.

In order to face the challenges of the future, it is a must that Sri Lanka repositions herself by adopting policies which maintain, reinforce and improve its competitive position, not only as a port and airport but holistically as an economic entity. In this backdrop focusing on logistics hub is a strategy worth investigation as an economically emerging country. The success of a regional logistics hub cannot be measured only through the number of Twenty Equaling Units handled at the ports or tonnages moved through the airports but it need to focus on the quality of logistic services provided as well. In competing with other low-cost margins operators and to achieve sustainable advantage a regional logistics hub should focus on providing high quality and efficient logistics services. This paper suggests to adapt FM concept as an important support function which could enhance the logistics performance of the emerging logistics hub-Sri Lanka.

References

- Al-Turki, U. (2011), "Methodology and theory. A framework for strategic planning in maintenance", *Journal of Quality in Maintenance Engineering*, Vol. 17 No. 2, pp. 150-162.
- Alsyouf, I. (2006), "Measuring maintenance performance using a balanced scorecard approach", *Journal of Quality in Maintenance Engineering*, Vol. 12 No. 2, pp. 13-149.
- Ancarani, A. and Capaldo, G. (2005), "Supporting decision-making process in facility management service procurement: a methodological approach", *Journal of Purchasing & Supply Management*, Vol. 11 Nos 5/6, pp. 232-241.
- Blanchard, B.S. (2004), *Logistics Engineering and Management*, 6th ed., Prentice Hall, Englewood Cliffs, NJ.
- Brandt, R.M. (1994), *A Guide to Strategic Facilities Planning*, Howarth, Holland, MI.
- Burdon, S. and Bhalla, A. (2005), "Lessons from the untold success story: outsourcing engineering and facility management", *European Management Journal*, Vol. 23 No. 5, pp. 576-582.
- Chew, M.Y.L., Tan, S.S. and Kang, K.H. (2004), "Building maintainability- review of the state of the art", *Journal of Architectural Engineering*, Vol. 10 No. 3, pp. 80-87.
- Datta, P.P. and Roy, R. (2010), "Cost modeling techniques for availability type service support contracts: a literature review and empirical study", *Journal of Manufacturing Science and Technology*, Vol. 3 No. 2, pp. 142-157.
- De Marco, A. and Mangano, G. (2011), "Relationship between logistic service and maintenance costs of warehouses", *Facilities*, Vol. 29 Nos 9/10, pp. 411-421.
- De Marco, A., Ruffa, S. and Mangano, G. (2010), "Strategic factors affecting warehouses maintenance costs", *Journal of Facilities Management*, Vol. 8 No. 2, pp. 104-113.
- Enoma, A. and Allen, S. (2007), "Developing key performance indicators for airport safety and security", *Facilities*, Vol. 25 No. 7, pp. 296-315.
- Gotzamani, K., Longinidis, P. and Vouzas, F. (2010), "The logistics service outsourcing dilemma: quality management and financial performance perspectives", *Supply Chain Management: An International Journal*, Vol. 15 No. 6, pp. 438-453.
- Goyal, S. and Pitt, M. (2007), "Determining the role of innovation management in facilities management", *Facilities*, Vol. 25 Nos 1/2, pp. 48-60.

- Harrison, A. and New, C. (2002), "The role of coherent supply chain strategy and performance management in achieving competitive advantage: an international survey", *Journal of Operational Research Society*, Vol. 53 No. 3, pp. 263-271.
- Hinks, J. and McNay, P. (1999), "The creation of a management-by variance tool for facilities management performance assessment", *Facilities*, Vol. 17 No. 1, pp. 31-53.
- Holberg, K. (2001), *Competitive reliability 1996-2000*, Technology Program Report 5/2001, Final Report, National Technology Agency, Helsinki.
- Jones, K. and Sharp, M. (2007), "A new performance-based process model for built asset maintenance", *Facilities*, Vol. 25 Nos 13/14, pp. 525-535.
- Kadefors, A. (2008), "Contracting in FM: collaboration, coordination and control", *Journal of Facilities Management*, Vol. 6 No. 3, pp. 178-188.
- Lai, J.H.K. and Yik, F.W.H. (2007), "Monitoring building operation and maintenance contracts", *Facilities*, Vol. 25 Nos 5/6, pp. 238-251.
- Lavy, S., Garcia, J.A. and Dixit, M.K. (2010), "Establishment of KPIs for facilities performance measurement: review of literature", *Facilities*, Vol. 28 Nos 9/10, pp. 440-464.
- Madu, C.N. (2000), "Competing through maintenance strategies", *International Journal of Quality and Reliability Management*, Vol. 17 No. 9, pp. 937-948.
- Meulen, P., Petraitis, M. and Pannese, P. (2008), "Design for maintenance", *Proceedings of IEE/SEMI Advanced Semiconductor Manufacturing Conference*, pp. 278-281.
- Noor, M.N.N. and Pitt, M. (2009), "A critical review on innovation in facilities management service delivery", *Facilities*, Vol. 27 Nos 5/6, pp. 221-228.
- Pintelon, L., Pinjala, S.K. and Vereecke, A. (2006), "Evaluating the effectiveness of maintenance strategies", *Journal of Quality in Maintenance Engineering*, Vol. 12 No. 1, pp. 7-20.
- Salaris, A. (2002), *Facilities Management Opportunities*, Quaderni Edilforma, Roma.
- Salonen, A. and Bengtsson, M. (2011), "The potential in strategic maintenance development", *Journal of Quality in Maintenance Engineering*, Vol. 17 No. 4, pp. 337-350.
- Scupola, A. (2012), "Managerial perception of service innovation in facility management organizations", *Journal of Facility Management*, Vol. 10 No. 3, pp. 198-211.
- Sherwin, D. (2000), "A review of overall models for maintenance management", *Journal of Quality in Maintenance Engineering*, Vol. 17 No. 1, pp. 5-25.
- Smith, J.D. and Tomkins, J.A. (1998), *Warehouse Management Handbook*, Tomkins Press, Raleigh, NC.
- Taillander, F., Sauce, G. and Bonetto, R. (2011), "Methods and tools for building maintenance planning arbitration", *Engineering Construction and Architectural Management*, Vol. 19 No. 4, pp. 343-362.
- Tucker, M. and Pitt, M. (2009), "Customer performance measurement in facility management", *International Journal of Productivity and Performance Management*, Vol. 56 No. 5, pp. 407-442.
- Wong, C.W. and Karia, N. (2010), "Explaining the competitive advantage of logistics service providers: a resource-based view approach", *International Journal of Production Economics*, Vol. 128 No. 1, pp. 51-67.
- Yoon, K.P. and Naadimuthu, G. (1994), "A make-or-buy decision analysis involving data", *International Journal of Operation and Production Management*, Vol. 14 No. 2, pp. 62-6

Samarawickrama, Sumanthri, et al (eds), 2018, "Sustainability for people - envisaging multi disciplinary solution": *Proceedings of the 11th International Conference of Faculty of Architecture Research Unit (FARU), University of Moratuwa, Sri Lanka, December 08, 2018* Galle pp. 123–131. ©

IMPACT OF SURFACE COVER AND SURROUNDING AREA ON MICROCLIMATE OF URBAN WETLAND PARK, NUGEGODA

MADHURANGA T. R. I.¹ & RAJAPAKSHA R. M. K. U.²,

^{1,2} Department of Architecture, University of Moratuwa, Moratuwa, Sri Lanka

¹isharavcc12@gmail.com, ²rajapaksha_upendra@yahoo.com

Abstract

Urban Wetland Park at Nugegoda was examined under this study. The work investigated three objectives. Effectiveness of different ground surface finishes to the microclimate (positively or negatively), wind pattern (wind directions and wind velocity) of the selected area to find out the effectiveness of wind pattern to the microclimate and the effectiveness of surrounding area over the wetland park, considering the build mass, traffic struck area and the water body. Temperature and relative humidity were obtained using HOBO data logger. Wind velocity was measured by anemometer and wind direction was measured using compass. The work observed an increase of air temperature in the investigated park by 5.34 °C above corresponding ambient air temperature. The heat which was generated in built mass, came attached to the air flow and it caused a rise in the temperature of park. Zone 01 and zone 02 records 2.5 °C higher temperature than zone 03. Zone 01 and 02 are directly exposed to the build mass, but in-between zone 03 and road area has a vegetated land. This vegetated land has caused a temperature drop in zone 03. The work highlights the significance of vegetated land as a buffer zone for negative effect from built mass. Surface cover is a significant factor which determines the deviation of temperature within a park.

Keywords: *Microclimate, Ground surface cover, Surrounding environment, Thermal comfort*

1. Introduction

"Wetlands" are water-rich natural areas that occur along rivers and in deltas. Those are the same places where most urbanization occurs. Urban expansions and the correspondingly lower groundwater levels put pressure on wetlands and associated nature, around the world. (Ehrenfeld, 2000). Currently, most of the wetlands are being cumulated because of human activities. As a result of decreasing these wetlands, the temperature of urban context is being increased. This will affect human behavior, as Li et al. (2018) mentioned atmospheric variables, such as temperature, precipitation, and sensible and latent heat fluxes are important for human society. Integration of green spaces in urban planning and building designs may, therefore be essential for adaptation to and mitigation of thermal impacts of both local and global warming processes (Feyisa et al., 2014).

"Microclimate" is the climate near the ground, that is the climate in which plants and animals live. It differs from the macroclimate, which prevails above the first few meters over the ground, primarily in the rate at which changes occur with elevation and with time. Whether the surface is bare or vegetated, the greatest diurnal range in temperature experienced at any level occurs there. Temperature changes drastically in the first few tens of millimeters from the surface into the soil or into the air. Changes in humidity with elevation are greatest near the surface (Norman J. Rosenberg, Blaine L. Blad, Shashi B. Verma, 1983). Temperature, humidity, atmospheric pressure and wind speed influence the cooling function of urban wetlands, while solar radiation modifies the humidification function of urban wetlands. Nowadays there are some constructed wetlands that can be seen in urban areas and also there are some wetlands which are partially converted to the man-made wetland parks. There are some important factors which directly affect the microclimate in the wetland. The ground surface cover is one crucial factor. There were many kinds of materials that are used as ground cover. Turf, paving, sand, concrete, timber, rubble, and different kinds of hard materials are used on constructed wetland parks. These materials are directly affecting to the micro-climate in surrounding areas. (Huang, Li, Zhao, & Zhu, 2008, p.8).

2. Objectives of the study

The primary objective is to, find out how the ground surface cover has an effect on the microclimate, according to the materials which are used for ground surface finishing such as rubble, interlock paving, concrete, soil, sand, lawn. Then to study the temperature and relative humidity (RH) variation of areas which are covered by above mentioned materials.

Another objective was to study the effectiveness of wind pattern over the microclimate.

3. Effects of Urban Cool Island and Water-cooling island (WCI)

As Du et al. (2016) mentioned, Urban Cool Islands (UCI) have great interest of mitigation of UHI and according to the previous researches verified that parks and greenspaces can provide UCI effects. A water body had exact water-cooling island (WCI) value. Wilson et al. (2003) mentioned that, a water body has high thermal capacity, low thermal conductivity, radiance (Costanza et al., 1998, Chang et al., 2007, and Cao et al., 2010, as cited in Du et al., (2016) and Zhou and Shu, (1994) found that a water body absorb less heat than buildings and other surfaces. Nevertheless, water area (WA) is a limited resource. Designing of water bodies can give a value to adjustment of micro-climate in landscape planning.

4. Outdoor thermal comfort and micro-climate

Thermal comfort of highly dense built area is different from that of highly vegetated park area. According to Gaspari & Fabbri (2017), outdoor thermal comfort depends on some inter-related factors such as characteristics of built environment, the relationship between materials and energy use, global climate change and local micro-climate.

5. Impact of Surface cover on air temperature

According to Johansson, Emmanuel, & Rosenlund (2004) mentioned that, concrete, asphalt and stone materials which have high heat capacity, absorbed solar radiation in urban surfaces will be stored in the material. Also, that study mentioned that, surface material properties have such a big influence over the urban climate.

The physiological equivalent temperature (PET) is a thermal index derived from the human energy balance and PET is preferable to other thermal indexes like the predicted mean vote because of its unit (°C) (Matzarakis, Mayer, & Iziomon, 1999). According to Deb (2010), PET can be calculated simply by the software RayMan, which is made freely available by its author.

The ground surface finish and surrounding area also affects the microclimate of a wetland. Build mass, water, and the roads are main factors of surrounding environment. The microclimatic conditions are also affected by the wind. The research question will be on whether the effect on the microclimate of a wetland is being affected by the ground surface cover and the surrounding area and if so, how the phenomena takes place.

Table 12, Ranges of the physiological equivalent temperature (PET) for different grades of thermal perception by human beings and physiological stress on human beings.

(Source: Matzarakis and Mayer, 1996)

PET	Thermal perception	Grade of physiological stress
4°C	Very cold	Extreme cold stress
8°C	Cold	Strong cold stress
13°C	Cool	Moderate cold stress
18°C	Slightly cool	Slight cold stress
23°C	Comfortable	No thermal stress
29°C	Slightly warm	Slight heat stress
35°C	Warm	Moderate heat stress
41°C	Hot	Strong heat stress
	Very hot	Extreme heat stress

6. Method and selection criteria of Urban wetland park, Nugegoda

Nugegoda is a highly urbanized suburb, situated near Colombo metropolitan region. It is a collection of commercial and residential buildings, and a densely congested and traffic struck road network. Different materials are used as a surface cover such as rubble and interlock paving, concrete and cement structures, lawn, sandy soil, and vegetation. The pilot study on this area shows extensive difference from ambient climate data. The park records higher temperature values.

An extensive difference can be observed with the materials that were used in the park. Front area is mainly covered by hard landscape materials than upper parts of the park. End portion of the park has been covered with concrete sleepers as ground cover (Figure 1, Place G). Middle part of the park shows no difference apart from the seating. The park is mainly divided into three zones known as Zone 01 (Place A, Place B, Place C), Zone 02 (Place D, Place E), and Zone 03 (Place F, Place G). Considering the surface cover and surrounding environment, the places are selected to collect the data in each zone. As shown in figure 1;



Figure 1, Three zones and data collected places called A, B, C, D, E, F, and G.

6.1. ENVIRONMENT OF ZONE 01, 02 AND 03

Front area of the park is named as a zone 01 (Figure 1). Different surface materials such as rubble, interlock paving, lawn, concrete and cement surfaces can be found. Place A (Rubble and interlock paving area), B (Concrete and cement surface area, water fountain area), and C (Lawn area) were selected according to above surfaces. The water fountain is in operation only within the hours of 1800H – 2000H daily. Middle part of the park is named as zone 02 (Figure 1). Water body acts as an immediate surrounding and the ground surface is compacted sand mix soil. The middle area of the jogging track is selected as Place D and junction which is located in end of the zone 02 is selected as Place E. Zone 03 is the end portion of the park. This area is mainly covered from vegetation, concrete sleepers and rubble are used as a surface cover in northern end of the park. In this zone, places are selected according to the surface material. Place F is covered with compacted sand mix soil area and Place G is covered with concrete sleepers and rubble area.

7.2. DATA MEASUREMENT PROTOCOL

The climatic data are taken from those sites along with 15-hour duration on 15th of July 2018, since 6 am to 9 pm. HOBO data logger (Temperature, humidity), Anemometer (Wind speed) are used to collect data. Data that are to be collected under outside data management are used as the input of the “RayMan Pro 2.1” software for thermal comfort calculations and Microsoft excel was used for data analyzing and forming graphs.

7. Field study at Urban wetland park, Nugegoda

7.1 VARIATION OF MICRO-CLIMATIC PARAMETERS IN ZONE 01

7.1.1 Directly proportional correlation among air temperature and wind velocity in zone 01

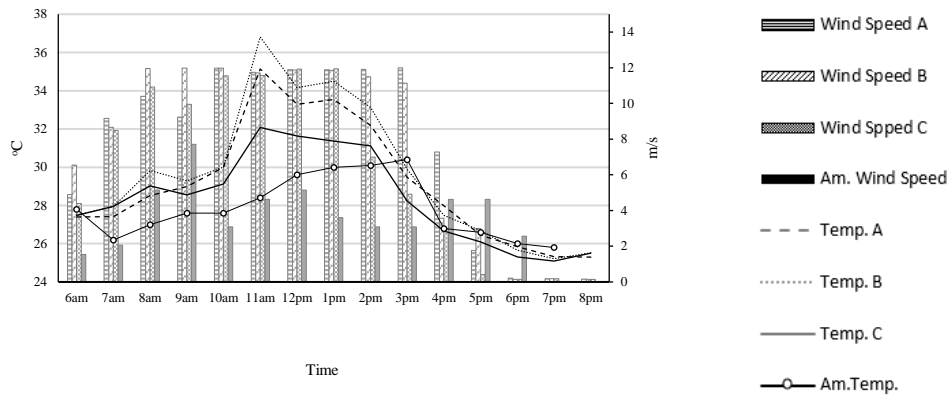

Figure 2, Temperature and Wind Velocity variation with ambient temperature and ambient Wind Velocity of Zone 01. Highest temperature is recorded as 36.81 °C in Place B

In Zone 01, wind speed is higher than the ambient wind speed. The graph indicates that from 6am to 10am, temperature of A, B, C places are rising up. The highest temperature is recorded at 11am. From 10am to 1pm, wind speeds of all three places are recorded to be at their highest and the same scenario with temperature as well. After 3pm, the temperature and wind speed gradually begin to decrease. After 6pm, the wind speed is lower than 1m/s and the temperature has gone lower than the ambient temperature. This shows a correlation between temperature and wind speed in Zone 01.

7.1.2. Zone 01 records higher wind velocity values than the ambient

Figure 3 indicates that, there is lesser variation of wind direction. The wind directions are limited in between south-west and west-north-west. According to the ambient wind speed, highest wind speed is recorded as 7.72 m/s. But it was recorded 11.9 m/s as highest wind speed in zone 01. There is a 4.18 m/s difference among ambient and zone 01 wind speed values. In this situation, the local climatic effects are dominated than the global climate conditions. The pressure fields are created around the park. As a result, wind velocity is higher than the ambient wind velocity, around the park area.

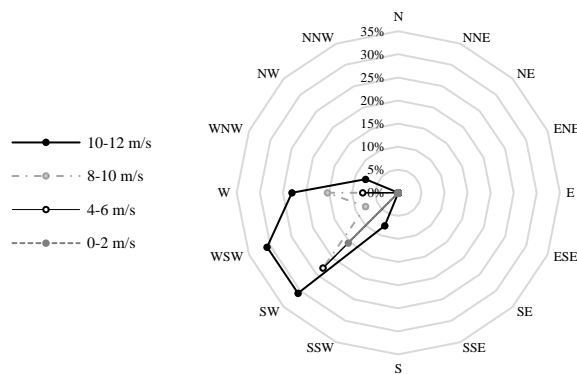

Figure 3, Windrose analysis of zone 01. Wind direction is south-west and 11.9ms⁻¹ is the highest wind speed.

7.1.3. Impact of the ground surface cover on increasing air temperature in zone 01

The temperature values of places in zone 01 can be arranged as C < A < B (Lawn area < Rubble paved area < Water fountain area) according to the ascending order. Area is covered by rubble and interlock paving, near the main road and build mass, place B area is located in close proximity with the water fountain area and it is fully covered with hardscape materials such as concrete and cement surfaces and also, place B area is covered by lawn. Pattern of the temperature variation of place A and B are equal unlike place C, because, the materials of that places are equal unlike place C.

7.2 VARIATION OF MICRO-CLIMATIC PARAMETERS IN ZONE 02

8.2.1. Correlation among air temperature and wind velocity in zone 02

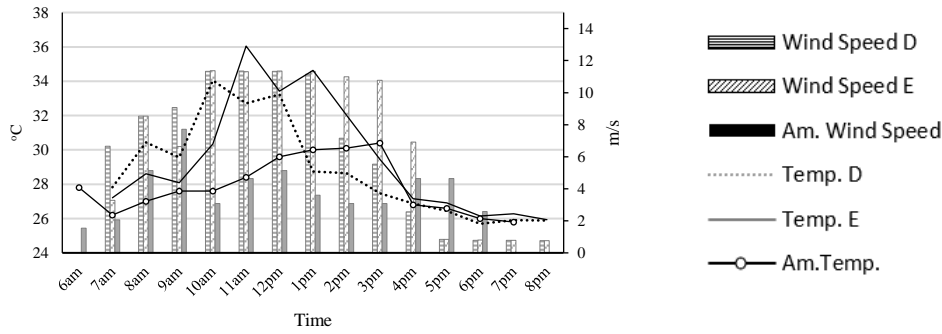

Figure 4, Temperature and Wind Velocity variation with ambient temperature and ambient Wind Velocity of Zone 02. Highest temperature is recorded as 36.05 °C in Place E.

Figure 4 indicates that from 7am to 10am, the wind velocity was raised up and the temperature also behaves according to the wind speed. At 9am, place E records 6.63 m/s and place D records 9.07 m/s as their wind speeds. Place D is higher than place E from 2.44 m/s. At that time, the air temperature records place E as 28.08 oC and place D as 29.56 oC. Place D is higher than place E from 1.48 oC. It shows that when the wind speed is high, the temperature also rises up in two places in same zone. After 1pm, place D wind speed shows a significant downturn until 5pm. The temperature of place D also began to decrease. The temperature is decreased by 6.77 oC. There is a directly proportional correlation among the temperature and wind speed after 1pm. After 4pm, all the temperatures are coming to a same value, but there is an extensive deviation among ambient and zone 02 wind speed values. Ambient wind speed is higher than the zone 02 wind speed. But there is an inversely proportional correlation among ambient temperature and wind velocity, and directly proportional correlation among zone 02 temperature and wind velocity.

7.2.2. Impact of wind direction to the air temperature in zone 02

Temperature in the Zone 02 is higher than the ambient. The wind has come from a direction in between west-south-west and west directions by crossing the build mass, water body area, and traffic struck area (Figure 4). Because of that, heat came attached to the air flow and it caused a rise in temperature of Zone 02. Thus, the rise of wind speed has no significant use over the park.

7.3. VARIATION OF MICRO-CLIMATIC PARAMETERS IN ZONE 03

7.3.1. Directly proportional co-relation with wind velocity and temperature of place G

The figure 5 indicates that there is an extensive difference between place F and place G wind velocity values. The figure 5 shows that the temperature pattern of both places are equal, but the levels of temperature values are different from each other. But after 10am, the pattern is changed. Wind velocity of place F was decrease by 5.88 m/s, but the temperature value of place F does not show any change in its pattern. But place G records highest temperature at 11am. At that time, the wind velocity of place G was also higher. It was recorded as 11.37 m/s.

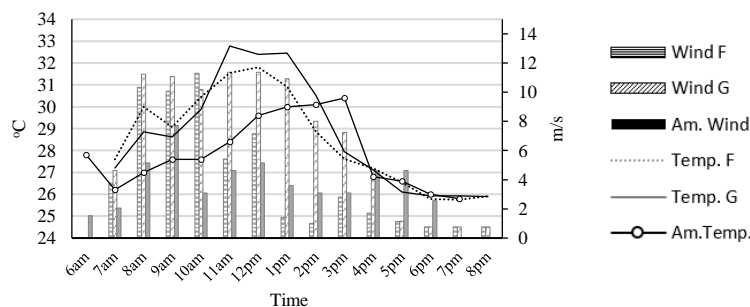

Figure 5, Temperature and Wind Speed variation with ambient temperature and ambient Wind Velocity of Zone 03. Highest temperature is recorded as 32.78 °C in Place G at 11am.

Within 11am to 1pm time period, the wind velocity and the temperature did not show any extensive variation in place G. The temperature of place G varied in between 32.78 oC and 32.39 oC. Wind speed varied in between 11.37 m/s and 10.93 m/s. After 1pm, wind speed of place G has begun to decrease gradually and be equal to place F wind speed at 5pm. Accordingly, wind velocity does not affect the temperature of place F. There is a co-relation with wind velocity and temperature of place G.

7.3.2. Impact of wind direction to the air temperature in zone 03

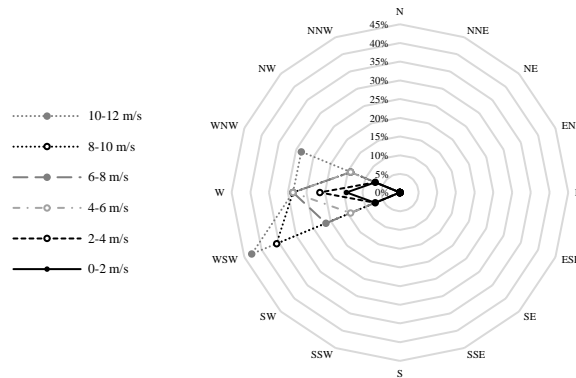

Figure 6, Windrose analysis of zone 03. Wind direction is west and 10.77 ms⁻¹ recorded as the highest

Temperature of the zone 03 is higher than the ambient temperature (Figure 6). The figure 6, wind rose analysis indicates that the wind came from a direction in between west-south-west and west-north-west directions by crossing the build mass, water body area, and traffic struck area. Because of that, heat came attached to the air flow and it caused a rise in temperature of zone 03. The rise of wind speed has no significant use for the park. But when place F is considered, the wind velocity does not affect to the temperature. Most prominently, surrounding and surface cover affects it.

7.4. PATTERN OF THE TEMPERATURE VARIATION IN BETWEEN ALL ZONES IN THE PARK AND AMBIENT VALUES

There is an extensive difference in between zones in the park and ambient temperature patterns, but the zones show a slightly similar pattern. The levels of the temperatures are different from each other. The highest temperatures are recorded at 11am in all zones. Zone 01 and zone 02 has a low difference as 0.3 oC, but zone 01 and zone 03 has extensive deviation. It shows a difference of 2.52 oC. According to above statements, there is a significant temperature difference in between zone 01 and zone 03. The ambient highest temperature is recorded at 3pm, but the three zones of park has recorded the highest at 11am.

7.5. IMPACT OF SURROUNDING ENVIRONMENT, WIND SPEED AND DIRECTION TO THE UPSURGE OF RELATIVE HUMIDITY

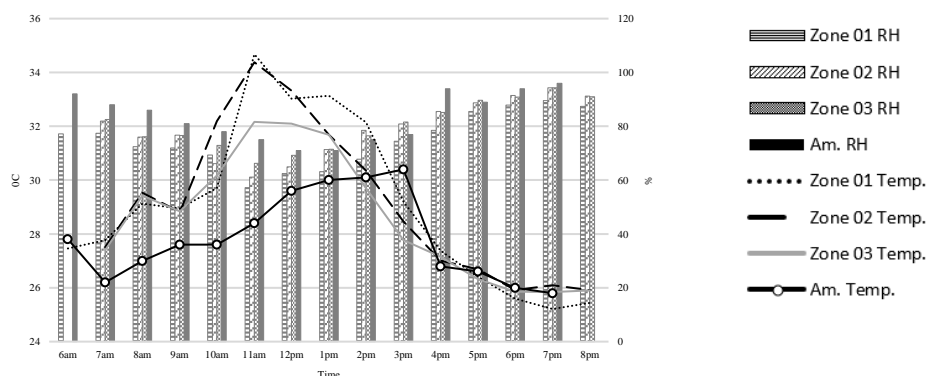

Figure 7, Temperature and RH variation of all zones in the park.

7.5.1. Behavior of temperatures

Results indicate that, the temperature of place F is independent from wind direction and wind velocity. The surrounding environment and ground surface cover are mainly affecting it. Marsh area, water body, trees and water plants act as the immediate environment. This has a negative effect on the wind flow. Because of that it caused to increase the RH level. The ground surface cover is the main cause to the temperature of place F. The pathway surface is covered with compacted sand mix soil. The place G surface is made by concrete sleepers and rubble. Generally, the specific heat capacity of concrete is higher than soil. (Johansson et al., 2004)

The Figure 7 indicates that the temperature of place G is beginning from a lower point than place F. But after 11am, place G temperature is higher than place F. It shows that, the place G is getting time to absorb heat than place F. According to above arguments, surrounding area and surface cover has a high influence over the variation of the temperature pattern of zone 03.

7.6. CORRELATION BETWEEN AIR TEMPERATURE AND WIND VELOCITY OF ALL ZONES

The wind velocities of all zones are different from each other. Zone 03 is recorded to have lowest wind velocity values. Wind speed of Zone 01 is higher than wind speed of zone 02. Then consider about wind speed values and temperature pattern of zone 02, a directly proportional co-relation can be identified. Within 8am to 10am time period, a subsidence of wind velocity values in all zones is seen. The temperature values also behave according to that variation. There is a directly proportional co-relation among the temperature pattern and wind pattern of the park.

According to the study, the wind is directed to the park from south-west direction. The wind came by crossing the build mass, and traffic struck area. Because of that, heat came attached to the air flow and it caused a rise in temperature of park, but zone 03 indicates lower temperatures than other two zones. There is vegetation in between build mass and zone 03. The wind came to the zone 03, after crossing that vegetated land. It can be suggested that, the vegetated land has acted as a buffer zone to the zone 03 (Figure 8).



Figure 8, Wind direction is coming to the park by crossing heat dense area.

7.7. THERMAL COMFORT OF THE PARK ACCORDING TO THE PET

Highest temperature is recorded at 11am and minimum temperature is recorded at 7pm of the park. Because of that, PET value is calculated to find the thermal comfort of the park, relative to the ambient. According to table 01 and figure 9, both ambient PET values are in between 230C and 290C. According to that, it has "Slight heat stress"

The park shows extensive difference from the ambient temperature. In the day time, all the zones are above 290C as a PET value. According to ranges of the PET values, it shows "Warm" as thermal perception and "Moderate heat stress" as grade of physiological stress. At the night time also, it is the same in zone 02 and 03, but zone 01 indicates "Slightly warm" and "Slight heat stress" level.

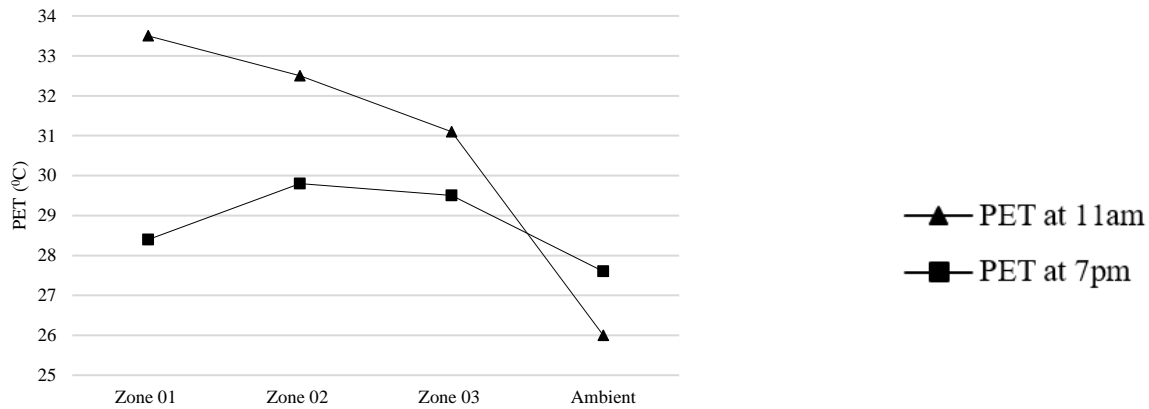

Figure 9, PET value of the park and PET value of the ambient

8. Conclusion

The analysis concludes that there are different temperatures recorded in different ground surfaces. All the temperatures of zone 01 are higher than the ambient. There is an inversely proportional correlation between ambient temperature and wind velocity, but temperature of all zones and wind velocity has a directly proportional correlation. Zone 02 has the same ground surface. But temperature pattern differs from each other. Also, humidity level of zone 02 is higher than zone 01 and place D is more humid than place E. It is because place D is surrounded by water than place E. It proves that though the ground surface cover is equal, temperature and relative humidity are influenced by surrounding area. Zone 03 is showing a different pattern of temperature variation than the two other zones and it records the lowest temperature in the park, however that is also higher than the ambient. When considering the surface temperature of the selected places, an inequality formula can be formed as below.

$$\text{Lawn} < \text{Concrete sleeper paved area} < \text{Rubble paved area} < \text{Soil and sand mixed} < \text{pathway} < \text{Water fountain}$$

Wind is directed from south-west and wind came by crossing the build mass, and traffic struck area. Because of that, heat comes with the air flow. That is the cause to increase the temperature of park, but different surface covers are reacting against the increase of temperature. Zone 01 and 02 are directly influenced by surrounding build mass to increase the temperature, but average temperature of zone 01 is little bit higher than zone 02, because surface cover is different than zone 01. Temperature of Zone 03 shows an extensive drop down when compared with the two others. It can be suggested that, wind which came crossing the vegetated area is the cause to the reduction of air temperature of zone 03. That vegetated land act as a buffer zone to zone 03. According to the thermal comfort level of the park, it is in Moderate heat stress level in the day time. In all three zones, zone 03 shows the least stress level when compared with other zones.

The study shows that, surrounding area and surface cover are more important to micro-climate of a wetland park, which is located in an urban context. Ground surface cover has an effect over the increase of air temperature of the park. Surface cover is a factor that has affected the heat coming from the surroundings. A vegetated surface cover can give a positive impact to heat coming from surrounding. For future design proposals, it can be suggested that, if there is any park in an urban area, a buffer zone in between built mass and park and vegetated surface covers will be helpful to mitigate the heat coming from surrounding. Apart from this case study, there is a possibility for future researches to be conducted with the aim of finding whether other public parks of the country are within this comfortability level or not.

9. Acknowledgements

Dr. D.P. Chandrasekara, Archt. Janaka Dharmasena, Mrs.Umeshika Fernando of Arthur C. Clarke institute of modern technology, Prof. Shiranee Balasooriya, and Landscape Archt. Kowshika Gunasena

10. References

- Du, H., Song, X., Jiang, H., Kan, Z., Wang, Z., & Cai, Y. (2016). Research on the cooling island effects of water body: A case study of Shanghai, China. *Ecological Indicators*, 67, 31–38. <https://doi.org/10.1016/j.ecolind.2016.02.040>
- Feyisa, G. L., Dons, K., & Meilby, H. (2014). Efficiency of parks in mitigating urban heat island effect: An example from Addis Ababa. *Landscape and Urban Planning*, 123, 87–95. <https://doi.org/10.1016/j.landurbplan.2013.12.008>
- Gaspari, J., & Fabbri, K. (2017). A Study on the Use of Outdoor Microclimate Map to Address Design Solutions for Urban Regeneration. *Energy Procedia*, 111, 500–509. <https://doi.org/10.1016/j.egypro.2017.03.212>
- Huang, L., Li, J., Zhao, D., & Zhu, J. (2008). A fieldwork study on the diurnal changes of urban microclimate in four types of ground cover and urban heat island of Nanjing, China. *Building and Environment*, 43(1), 7–17. <https://doi.org/10.1016/j.buildenv.2006.11.025>
- Johansson, E., Emmanuel, R., & Rosenlund, H. (2004). Microclimate and thermal comfort in the warm humid city of Colombo, Sri Lanka, 6.
- Liyanage, J., 2003. Air Quality Management, City Report-Colombo, Sri Lanka. In: Proceedings of the Kitakyushu Initiative Seminar on Urban Air Quality, Management, Bangkok, Thailand, February, 2003.
- Matzarakis, A., Mayer, H., & Iziomon, M. G. (1999). Applications of a universal thermal index: physiological equivalent temperature. *International Journal of Biometeorology*, 43(2), 76–84. <https://doi.org/10.1007/s004840050119>
- Oke, T.R., 1973. City size and the urban heat island. *Atmos. Environ.* 7, 769–799.
- Rizwan, A. M., Dennis, L. Y. C., & Liu, C. (2008). A review on the generation, determination and mitigation of Urban Heat Island. *Journal of Environmental Sciences*, 20(1), 120–128. [https://doi.org/10.1016/S1001-0742\(08\)60019-4](https://doi.org/10.1016/S1001-0742(08)60019-4)
- Senanayake, I. P., Welivitiya, W. D. D. P., & Nadeeka, P. M. (2013). Remote sensing based analysis of urban heat islands with vegetation cover in Colombo city, Sri Lanka using Landsat-7ETM+data. *UrbanClimate*, 5, 19–35. <https://doi.org/10.1016/j.uclim.2013.07.004>

Samarawickrama, Sumanthri, et al (eds), 2018, "Sustainability for people - envisaging multi disciplinary solution": *Proceedings of the 11th International Conference of Faculty of Architecture Research Unit (FARU), University of Moratuwa, Sri Lanka, December 08, 2018* Galle pp. 132–138. ©

SIMULATION BASED DESIGN FOR SUSTAINABLE AND CONTEXTUAL ARCHITECTURE

SHAMMI AKTER KEYA. A¹ & NOSHIN SIARA PROMY. B²

¹Rajshahi University of Engineering & Technology, Rajshahi, Bangladesh, ²Khulna University of Engineering & Technology, Khulna, Bangladesh

¹keya0801048@gmail.com, ²noshinpromy@gmail.com

Abstract

The built environment is a highly complex ecosystem that involves many interdependent systems. To ensure the optimum working built environment the increasing emphasis on building performance is influencing building design, its processes and practices. As a result the silver lining between the appearance and performance of building design is blurring and distinctions between geometry and analysis is getting lesser. Now to what extent performance actually influences design and what performance means in architecture has become a major concern as there has been a shift of orientation in architectural theory and practice, from what the building is to what it does. Making a built environment most workable and energy efficient- these two have become the most important issues to address while designing a building in any location because that's what will make the inner ecosystem run better for a better world altogether. For instance, a building, situated in a particular location, which is zero energy efficient and has optimum work environment can be completely proved unsuitable and even harmful in another context. Therefore it is mandatory to realize the contextual impact on the building itself whereas analyzing the building's impact on the environment within and outside is equally important. This is when the emerging emphasis on SBD (simulation based design) in architecture for better building performance becomes absolute. With the help of simulation based analysis at early design stage a building design can evolve more efficiently in performance towards users and environment thus ensuring sustainability. In this paper, a comparative analysis of a building's built environment in two different contextual situations has been done with the help of different simulation software (e.g. Ecotect, Vasari) to find out the necessary changes to make that building's design adaptable, in terms of form, façade, orientation, material etc, for those respective contexts.

Keywords: *Built environment; building performance; contextual architecture; sustainability; SBD (simulation based design)*

1. Introduction

A very recent approach towards architecture is the emerging preference of building performance above every other aspect in architectural design. Little has been written about performance in architecture. Yet this term performance has been widely used by owners designers, engineers, cultural theorists, etc. Performance in architecture increasingly matters; however, it means different things to different people. Utilizing digital technologies of quantitative and qualitative performance-based simulation to ensure optimum building performance has become a very useful technique towards sustainable environment. In this new information and simulation driven design context, multiple dimensions of architectural design from spatial, social and cultural to purely technical (structural, thermal, acoustical, etc) aspects can be addressed. The increasing emphasis on building performance from the socio cultural context to building physics is influencing building design, its processes and practices, by blurring the distinctions between geometry and analysis, between appearance and performance. By integrating the design and analysis of buildings around digital technologies of modeling and simulation, the architects' and engineers' roles are increasingly being integrated into a relatively seamless digital collaborative enterprise from the earliest, conceptual stages of design. This overall process certainly holds the positive impact of the designers being able to predict the built environment's impact on both the dwellers and the climate of the surroundings.



Figure 1. Building performance simulation model with input and some resulting output (Source: Wikipedia)

2. Background

Ensuring sustainability while designing a building has always been a challenge as high quality indoor environment and acceptable costs do not come hand in hand easily. Besides with the industrial development, using local materials successfully have been added to the sustainability factor. As a result, the design decisions of a building have to be more accurate and more performance based and therefore the emerging emphasis on simulation based analysis at early stage of building design to ensure optimum workable built environment can't be denied.

This paper documents the adaptability process of a residence, designed by a master Architect, from one context to a different context that has both social and climatic differences. The overall impact of context variation on building itself has been analyzed and discussed in this paper thoroughly with possible adaptable solutions for the specific project.

3. Objectives

Contemporary architecture is now facing that era where sustainable building design and building technology is fundamental for the growth of it (Henry H Glassie, 2000). Practicing architects are being considered responsible to design buildings that are environmentally sustainable with the change in the global concern regarding the use of energy and resources (Wines and Jodidio, 2000; Cox, 2009; Friedman, 2012). In this study key aspects of sustainable architecture practice with the help of different energy simulation software based analysis have been discussed.

Simulation Based design concept has several objectives to be followed in this field-

- Better concept promotion
- Standardization of input data and accessibility of model libraries
- Standard performance assessment procedures
- Better embedding of SBD
- Identifying drawbacks of SBD implementation

4. Methodology

The study was conducted through content analysis and different simulation based analysis of the selected building;

- Content analysis: Relevant research works, books and literature were reviewed to get a general overview of how simulation based analysis has been utilized in different contexts while designing energy efficient buildings and the percentage of simulation usage in the early stage of design.
- Site analysis: Both of the sites (Fort wayne, Indiana and Dhaka, Bangladesh) have been analyzed with the help of simulation software Ecotect and necessary changes have been made based on the analysis result in terms of form, facade, orientation and plan.

5. Literature Review

Historically, the use of simulation on practical problems is undertaken, predominantly, by specialized environmental systems engineers or research groups (commercial, government funded or academic), usually focused on specific problems [McElroy et al 1999]. This situation gives rise to simulation exercises being undertaken, generally, later on within the design process (scheme or detail design stages [RIBA 1995]) with the purpose of validating design decisions. This situation is due to the limited availability of resources for simulation work at early design stages and limited understanding of the benefits of using simulation by design team members. However, changes in procurement methods and legislation have provided strong incentives for the use of simulation within architectural practice. The use of simulation facilitates better understanding of the design problem with respect to energy performance, often highlighting poor performance of design concepts: the need to change designs to mitigate this under-performance at the later design stages can be costly.

Design tools have traditionally been constructed by reducing the complexity of the underlying system equations in an attempt to lessen the computational load and the corresponding input burden placed on the user. Some portion of the system may be neglected (e.g. long wave radiation exchange), time invariant values may be assigned to some system parameters (e.g. material thermal properties) or simple boundary conditions may be imposed (e.g. steady state or steady cyclic). Within a simulation program such assumptions are heresy. Instead, a mathematical model is constructed to represent each possible energy flow path and their interactions. In this sense simulation is an attempt to emulate the reality. This is an evolution of different tools to predict real time experience of the dwellers of a building. In order to ensure the optimum result it's necessary to-

- obtain an appropriate level of knowledge of the issues of computer modeling within practice
- develop a robust understanding of how, where and when simulation can be used
- develop of collaboration between key individuals within practice.
- identify potential drivers for the increased use of simulation.
- Creating interface/software development to increase functionality and ease of use.

5.1. COMPARATIVE SITE ANALYSIS AND FINDINGS

The study has been done in two different sites considering the different environmental impacts on the building. The Hanselmann House by Architect Michael Graves in Fort Wayne, Indiana has been taken as a case and firstly the built environment at that site has been analyzed. Then the site considerations have been altered according to the context of Dhaka, Bangladesh. Based on the analysis results necessary changes have been made in building plans and façade to gain optimum built environment results.

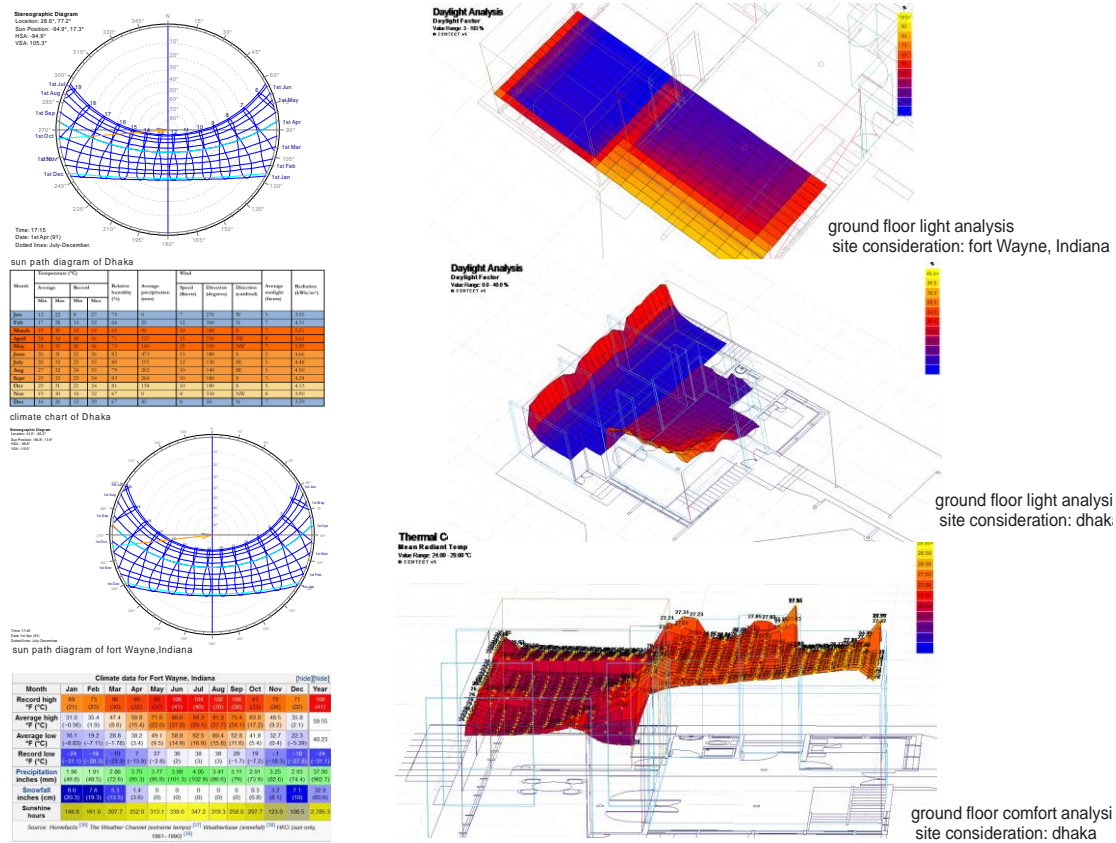

Figure 2. Comparative light analysis of Hanselmann House by Michael Graves considering two site contexts (Fort wayne, Indiana and Dhaka, Bangladesh) simultaneously (Source: Author, simulation software: Ecotect)

From the data comparisons, some basic differences can be identified at a glance such as the highest temperature gain and lowest temperature fall in the two contexts throughout the year. Moreover the precipitation ratio varies way differently in Dhaka than Fort Wayne.

The climatic condition in Dhaka is more humid and temperature gain is high. Dhaka experiences a hot, wet and humid tropical climate. Dhaka has a tropical wet and dry climate. The city has a distinct monsoonal season, with an annual average temperature of 25 °C (77 °F) and monthly means varying between 18 °C (64 °F) in January and 29 °C (84 °F) in August. Nearly 80% of the annual average rainfall of 1,854 millimeters (73.0 in) occurs during the monsoon season which lasts from May until the end of September.

While in Fort Wayne, Indiana gets 37 inches of rain, on average, per year. In summer, around in July the temperature gets high up to 84 degrees and in winter around 17 degrees in January.

Further building analysis based on light, thermal comfort and wind flow shows the possible spaces within the building to be modified. Therefore identification of below facilitated spaces was easily achievable and design decisions at early stage of design became more authentic.

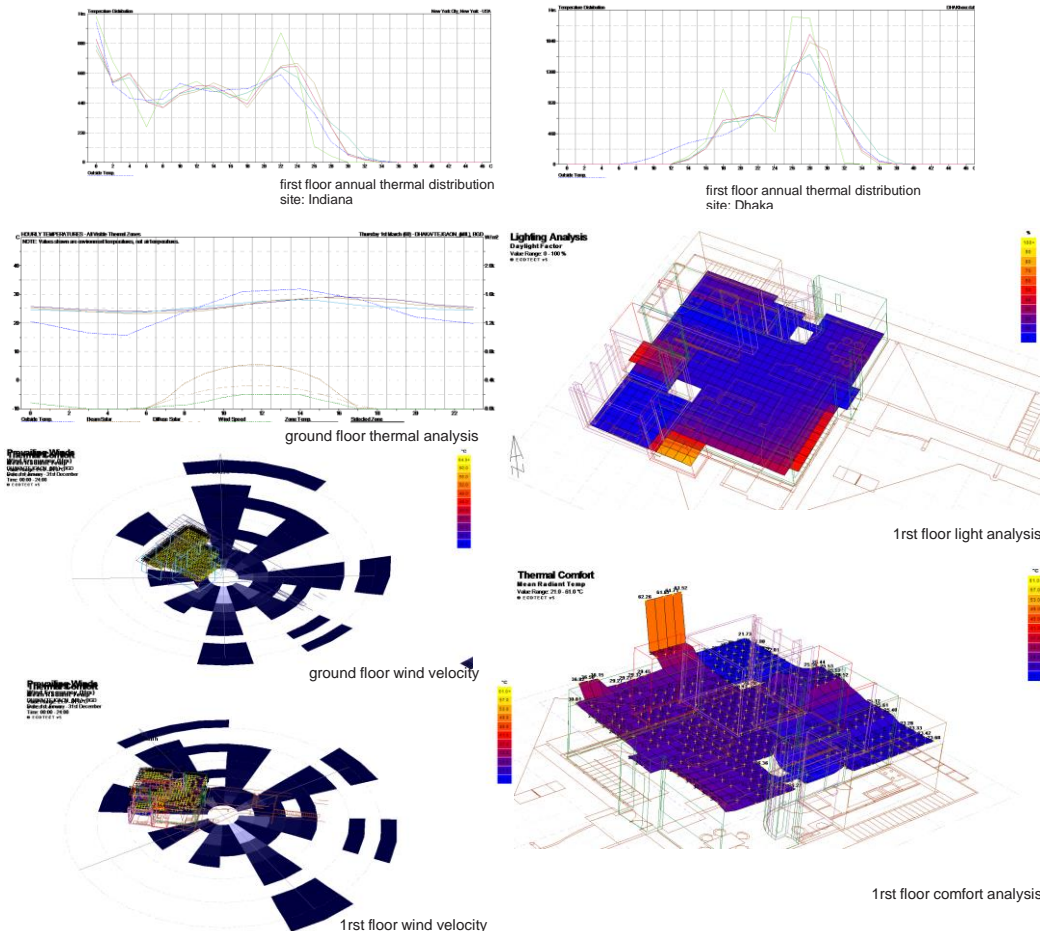

Figure 3. Comparative wind and thermal analysis of Hanselmann House by Michael Graves considering two site contexts (Fort wayne, Indiana and Dhaka, Bangladesh) simultaneously
 (Source: Author, simulation software: Ecotect)

6. Necessary Adaption and Modification of Building Layout

To ensure contextual architecture, based on the analysis data derived from the simulations zoning layout of the building has been changed. As the simulations show that, following the context of Fort Wayne, Indiana, location of void spaces within the building has been designed and functions relevant those locations have been placed respectively. But the same design becomes obsolete considering the context of Dhaka for functions within the building such as the master bed room, the kitchen and the openings.

6.1. CHANGES IN THE FACADES

In this study, to ensure the building is optimum energy efficient necessary modifications in the building façade have been made according to the analysis data derived from Ecotect.

For instance, analyzing the wind flow pattern and thermal comfort level, it is suggested to ensure cross ventilation through maximum functions preferably within which the dwellers spend most of their time. Considering the site context, orienting the building void in the south east corner can be the preferable solution to ensure maximum wind flow reception. Locating the major functions on the upper floors and the service functions in the ground floor level is suggested to ensure proper wind flow through those functions.

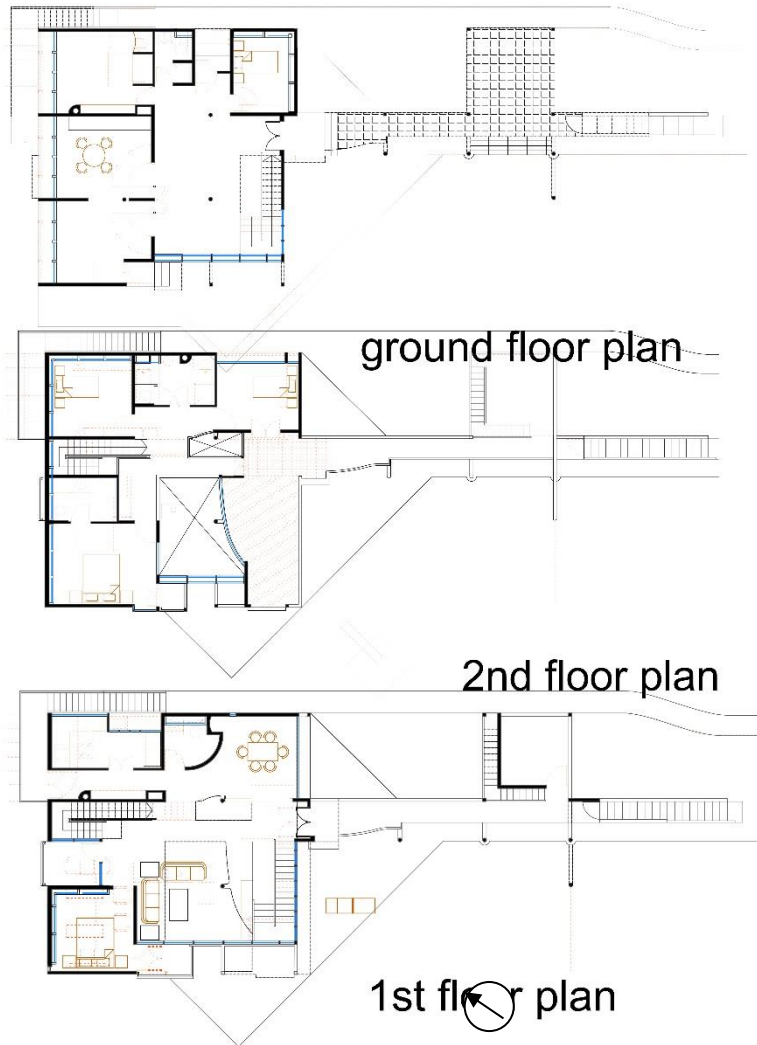

Figure 4. Layout modification of the building for Dhaka based on the climatic analysis from simulations
 (Source: Author, simulation software: Ecotect)

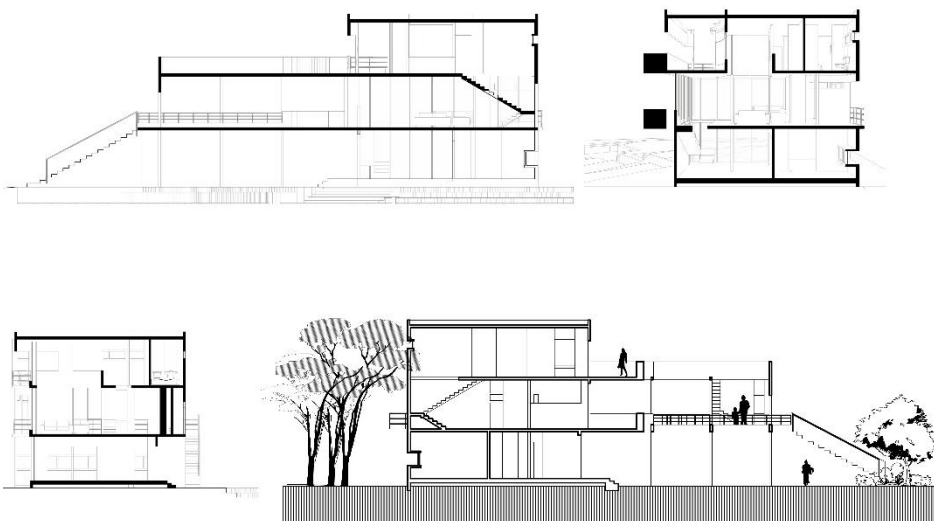

Figure 5. Window detail modification of the building for Dhaka based on the climatic analysis from simulations
 (Source: Author, simulation software: Ecotect)

Here based on the Ecotect analysis using climate data for temperature and precipitation level changes, necessary modification has been adopted in terms of window details. From the analysis, it is shown that precipitation level and wind flow in Dhaka is higher than Fort Wayne, Indiana. As a result the building façade in Indiana doesn't require any shading device and the Architect successfully achieved the cubic form here. On the other hand, in the context of Dhaka, it's essential to provide shading device not only for sun protection but also rain protection. Addition of external shading device could hamper the conceptual cubic form that's why alternative solution has been taken and most of the windows have been transformed into recessed windows. North façade openings have been enlarged to receive maximum light in the interior.

8. Conclusion

Designer, design decisions and design tools are three major elements in design which have to be directly connected all through the process. There is no denying the fact of insignificant development of proper design process to ensure optimum building performance. Simulation based design can certainly add another dimension in the overall decision making process and properly using it at the early stage can help a design evolve accordingly to the requirements of a context. This study has immense possibilities that can be conducted to post-process the simulation results to meet the needs of individual actors from multiple perspectives, and to extend the field of simulation based design profoundly in order to ensure sustainability in building design, maximizing user comfort and thus ensuring the optimum built environment performance.

9. References

- J A Clarke (ed.): 2001, *Energy Simulation in Building Design*, Butterworth-Heinemann; 2 edition (October 16, 2001)
- Branko Kolarevic & Ali M. Malkawi (ed.): *Performative Architecture Beyond Instrumentality*, Spon press, Taylor & Francis Group, New York & London.
- Marsh, A. (2008). *Generative and Performative Design: A Challenging New Role for Modern Architects*, The Oxford Conference. 22-23 July, Oxford, UK WIT Press
- Shannon, R. E. (1975). *Systems simulation: the art and science*, Prentice Hall, Inc.
- Deru, M. and Torcellini, P. 2004, *Improving Sustainability of Buildings Through a PerformanceBased Design Approach*, World Renewable Energy Congress VIII and Expo Denver, Colorado

Samarawickrama, Sumanthri, et al (eds), 2018, "Sustainability for people - envisaging multi disciplinary solution": *Proceedings of the 11th International Conference of Faculty of Architecture Research Unit (FARU), University of Moratuwa, Sri Lanka, December 08, 2018 Galle* pp. 139–146. ©

BODY-CENTRIC TRANSFORMABLE ADORNMENTS: A SUSTAINABLE APPROACH

JAYAWARDHANA KOMANGODAGE METHMA JAYAWARDHANA¹ & K.K.G.I.C. SAMARASEKARA²

^{1,2}Department of Integrated Design, University of Moratuwa, Sri Lanka

¹*methujk@gmail.com*, ²*inokasamarasekara@gmail.com*

Abstract

Emerging trends, fast fashion and the current patterns of consumer behavior leads to overconsumption which traces a negative impact on sustainable practice. It is observed that the current patterns of unsustainable consumption results in a variety of wastage problems including materials. To overcome this issue, the industry has developed innovative techniques, yet fabric wastage has become the main concern. Considering jewellery, metals as a nonrenewable material should be thoroughly concerned under this matter due to its preciousness and expensive manufacturing processes. Thus, this paper aims to discuss a potential sustainable approach addressing the overconsumption of metals via body-adornment. It was revealed that the concept of 'transformability' and its application occupies the sustainable strategy. Thus, the main objective of this practice-lead research is to provide a sustainable solution for overconsumption in jewelry industry through transformable adornments while fulfilling the desires of the contemporary consumer. The research is based on a series of experiments on body-centric transformable adornments. A theoretical framework on 'wear-ability' was involved to provide a dynamic experience to the wearer. The outcome of the research is a collection of conceptual body-adornment. The feasible capacity of transformable jewellery was the main finding of the research along with the capability to develop this idea into commercially viable sustainable designs.

Keywords: *Sustainable; adornments; transformability; wear-ability.*

1. Introduction

"Sustainability" has many definitions, and one describes "a process that helps create a vibrant economy and a high quality of life, while respecting the need to sustain natural resources and protect the environment (Clough, G. et al, 2006). Seidman (2007: 58 as cited in Joy, A. et al, 2012) notes, "Sustainability is about much more than our relationship with the environment; it's about our relationship with ourselves, our communities, and our institutions." Over the past decade, sustainability and ethical approach have begun to matter in fashion (Joy, et al., 2012) thus, the term 'Ethical Fashion' emerged as a trend to approach the sustainability (Gongini, 2017). Fashion industry has been identified as one of the most polluted industries due to fast fashion and overconsumption (Salari, 2017). The continuously emerging trends and the changing desires of wearers have an effect on the said problem. Several sustainable fashion approaches were developed by designers for years and various innovative materials, techniques and concepts came out as the results. Meanwhile, the concept of transformability emerged as a new fashion trend and with its capability to fulfill the aspects of sustainability; was converted as an approach to sustainable fashion specifically to the apparel industry (Gong, 2014). But when it comes to jewelry industry, sustainability is more about material mining and manufacturing processes (Anon., 2018). Thus, the research explores how the concept of transformability can be employed as a sustainable movement for the jewellery industry.

2. Concept of transformability in fashion

The term 'transformability' refers to any wearable item which is designed in a way that its appearance can be easily altered in to another new wearable option (Peter, 2018). The importance of transformability is, that it completes most of the aspects of sustainable fashion which is also known as 'ethical fashion' (Peter, 2018). Simply, a garment design with so many options and appearances to wear will persuade the wearers to buy fewer clothes (Peter, 2018). With the application of transformability for designs, the environment benefits due to less wastage and contemporary wearers get satisfaction from the unexpected design options.

2.1 SIGNIFICANCE OF TRANSFORMABILITY IN JEWELLERY

In the jewelry industry, material mining and manufacturing processes are often considered as sustainable threats (Anon., 2018) since the production of materials and manufacturing processes directly make an impact on the environment. Therefore, jewellery industry has found innovative recyclable materials and also manual craft techniques (Huynh, 2018).

Instead of those innovations, transformability can be applied into the jewellery designs as in apparel sector considering the wearer's aspect. The existing applications of transformability in the jewellery industry is evidently minimal. For instance, the usage of precious metals and gems have not reduced, the range of transformable options offers to the consumers are limited and pre-defined (Chen, 2017). Thus, it can be affirmed that the potential of transformability is yet to be explored.

3. The means of human body via transformable jewellery

When transformability is applied in jewellery designs, the wearer should feel comfortable and be astonished with the activity of transformability as the wearer's aspect is more important when developing a contemporary jewellery movement. Also to make the maximum use of transformability, the wearer's involvement is needed to transform the jewellery. Therefore, the human body and its behaviour should be thoroughly considered when designing transformable jewellery.

3.1. THE SIGNIFICANCE OF BODY-CENTRIC TRANSFORMABILITY

It can be said that the human body is the main concern for designing transformable jewellery, thus, the idea is converted into body-centric transformability. The term 'body-centric' refers to the idea of concerning physical features and behaviours of the human body (Chen, et al., 2011). Furthermore, body movements should not be disturbed by the design itself. Body-centric transformable jewellery should be capable of providing several wearable options while making the wearer comfortable and giving a gratifying wear-ability experience in each and every wearable option. This creates a sense of satisfaction about adorning the jewellery and that is how the contemporary wearer embraces body centric transformability as a new movement in jewellery.

3.2. ACHIEVING BODY-CENTRIC TRANSFORMABILITY THROUGH DYNAMIC HUMAN BODY

The human body is dynamic and it follows a specific set of movements which can be easily observed and learnt. Also, the human mind has the capability to feel and understand the way of adorning. When the transformable jewellery is adorned, the designs should not restrict the wearer's movements and the dynamism of wear-ability should be considered. Wear-ability defines the capability of wearing a wearable object easily and comfortably. Dynamic wear-ability can be defined as, the interaction between the adornment and the human body in motion (Gemperle, et al., 1998).

Within this context, a theoretical framework based on the dynamic aspect of human body and the wear-ability was employed for the experiments. -Based on the 13 guidelines on dynamic wear-ability (Gemperle, et al., 1998) the most appropriate guiding principles (mentioned below) are employed for the experiments.

1. Placement (where on the body it should go)
2. Form Language (defining the shape)
3. Human Movement (consider the dynamic structure)
4. Proxemics (human perception of space)
5. Weight (how it's spread across the human body)

4. Experiments on body-centric transformable adornments

Potential of the material to use for designing transformable adornments and the capability to follow the wear-ability theories were considered when selecting the appropriate materials for the experiments. Brass and Copper were selected as they carry the recyclable quality as well which contributes heavily to sustainability (Leblanc, 2018).

When selecting the technique for the collection, numerous experiments were carried out considering the transformability and ability to follow the guidelines as follows.

4.1. TECHNIQUE SELECTION

At first, several experiments with metal sheet pieces were done (Figure 1). The intention of this step was to identify the most pertinent shape for the designs. The outcome shows, the circles with middle

circular cuts being the most appropriate and the adaptable technique. The selected shape could be easily achieved by metal wires, thus the metal loops were selected as the basic module for the designs.



Figure 1, Experiments done with different shapes using metal sheets
(Source: Author)

Technique which utilizes metal loops as the repeating unit is recognized as chainmail techniques. Since there is a variety of chainmail techniques and each pattern has different qualities, several experiments were carried out (Figure 2).



Figure 2, Experiments with different chainmail techniques (Source: Author)

Considering the adaptability with body forms, the Japanese 12 into 1 chainmail technique was selected considering the feasibility to use as a transformable technique and the capability of following the theories of dynamic wear-ability (Figure 3).



Figure 3, Japanese 12 into 1 chainmail technique (Source: Author)

4.2. DESIGN VISUALIZATION

Thumbnail sketches were done to visualize the basic silhouettes of the designs and then the detailed drawings were done to plan the designs with transforming options (Figure 4).

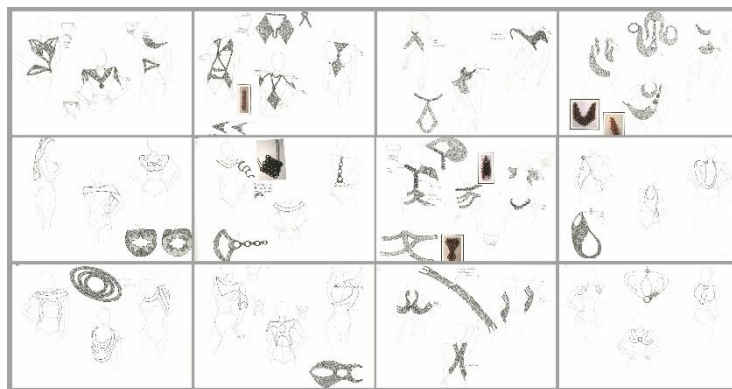

Figure 4, Detailed sketches (Source: Author)

4.3. PROTOTYPE EXPERIMENTS WITH THE LIVE HUMAN BODY

Experiments were done with different wire gauges and diameters in order to identify the suitable sizes for the adornments (Figure 5). Findings revealed, the wires with lower gauges (0.5mm to 0.8mm) were not able bear the formation of the technique and the loops with lower diameters (2mm to 4mm) made the piece awfully flexible and disturbed the transformation. Therefore 8mm to 10mm diameters were selected for the experiments.

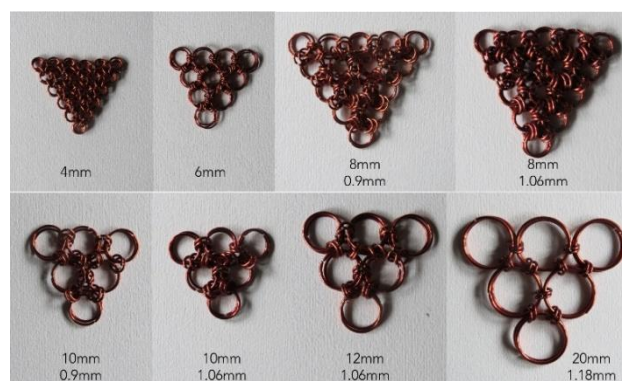

Figure 5, Experiments on wire gauges and loop diameters (Source: Author)

Thereafter, the placement experiments were done with a mannequin and a live human body in order to verify the practicality (Figure 6).



Figure 6, Prototype experiments with the live human body (Source: Author)

A series of prototypes were experimented and developed based on wearer's feedback on comfort and wear-ability prior to the final design options.

5. Design options and findings

Design option 01; is a stripe which has linear openings within the design (Figure 7). It mainly adorns the shoulder, chest and bust areas. The shoulder bones (clavicle (collar bone)) hold the adornment steadily in every design option under design 01 (Figure 8). The way that the two colours are used within the design emphasizes the formation of the nape area and the application of different loop diameters makes the design adaptable to the nape curvature (Figure 8).

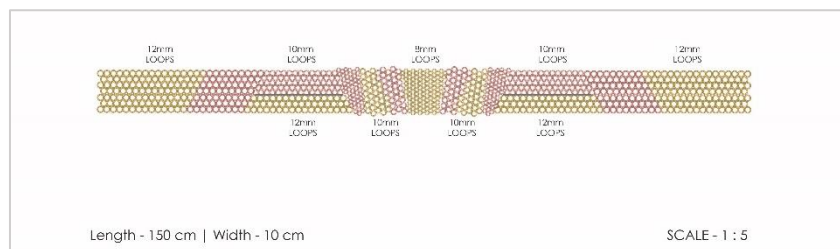

Figure 7, Design option 01 – technical drawing (Source: Author)



Figure 8, Design option 01 – wearable options (Source: Author)

Design option 02; has an oval shaped silhouette with two layers of chainmail stripes (Figure 9). It adorns the shoulder, chest, bust and waist areas mainly. All the transformed design options are held by the shoulder and the chest. The use of colour demonstrates the two main sections within the design and the placements that the design can be worn (Figure 10).

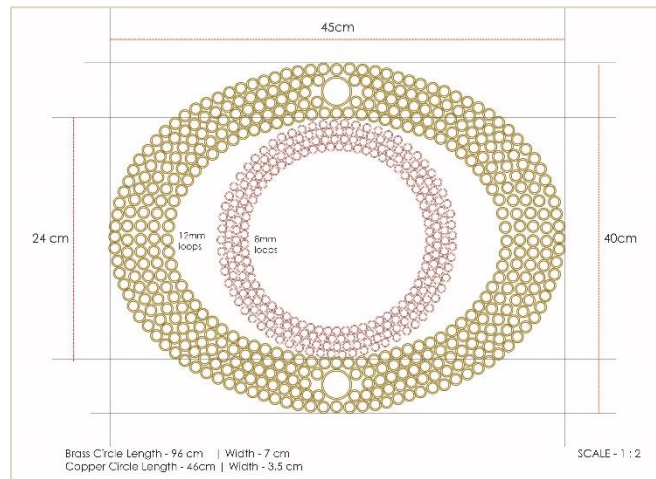

Figure 9, Design option 02 – technical drawing (Source: Author)



Figure 10, Design option 02 – wearable options (Source: Author)

Design option 03; has a symmetrical silhouette which has wider openings at the sides and the middle (Figure 11). It adorns complete upper torso with all the 3 design options. In this design option, the shoulder, chest, bust, waist are adorned with the back of the upper torso and the hip. The use of colour contrast within this design is applied in a way which guides the wearer to wear the options (Figure 12).

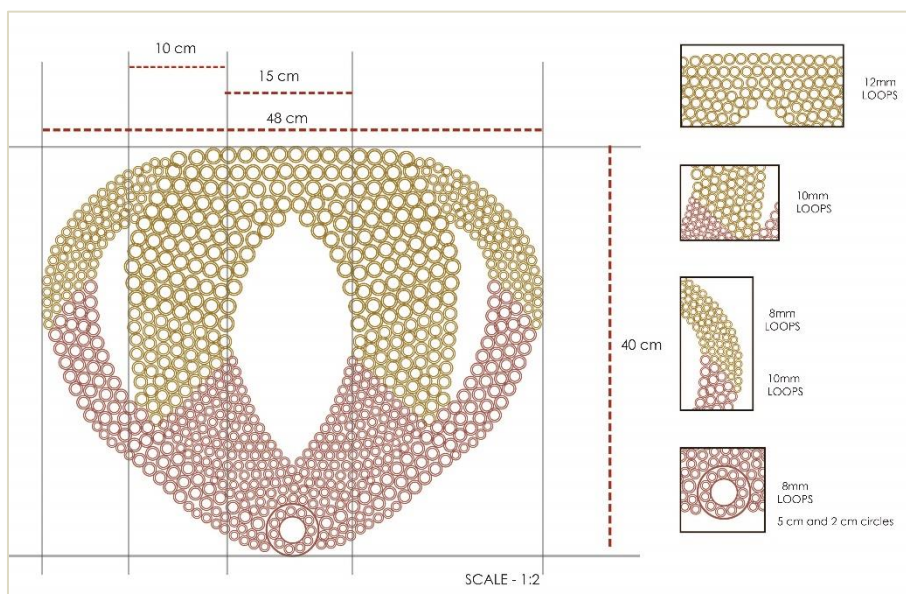

Figure 11, Design option 03 – technical drawing (Source: Author)



Figure 12, Design option 03 – wearable options (Source: Author)

6. Discussion and Suggestions

Outcomes of the research express many areas of potential which are capable of fighting with the threats for sustainably. The application of semi-precious metals; copper and brass adds a more sustainable value to the collection due to its availability, the inexpensive production and the recyclable quality.

Chainmail technique highlights throughout the collection as a precious craft technique. Giving an opportunity to the craft sector and using manual skills without depending on expensive machines and manufacturing techniques is also a way to achieve sustainability. Using transformability and giving the collection a significance regarding human body clearly becomes a sustainable solution and an emerging trend for the jewellery industry.

Therefore, the research findings provide a sustainable and a trendy solution for the jewellery industry while accomplishing the contemporary consumer preferences which could be further developed into commercially viable products.

7. Conclusion

Transformable adornments depict a novel approach to sustainable jewellery through body-centric approach.

As designers, it is important to explore innovative methods and applications which are beneficial to the industry. This practice led research provides a plausible answer for unsustainable consumption as a contemporary jewellery movement.

Throughout the research, semi-precious metals have been recognized as the potential materials for sustainable jewellery compatible with existing sustainable materials. Besides, the maximum use of chainmail techniques was employed. In conclusion, this research can be concluded as a new knowledge and an innovative way to fight against the existing threats to sustainability while using what the jewelry industry already have as materials and techniques.

8. References

- Anon., 2018. *Sustainable Jewelry*. [Online]
Available at: <https://www.ecolustre.com/sustainable-jewelry>
[Accessed 23 October 2018].
- Ben-Eli, M., 2015. Introduction. *Sustainability : Definition and Five Core Principles*, p. 2.
- Chen, V., 2017. *High jewellers turn heads with transformable pieces*. [Online]
Available at: <https://www.scmp.com/magazines/style/watches-jewellery/article/2086717/high-jewellers-turn-heads-transformable-pieces>
[Accessed 24 October 2018].
- Chen, X., Tang, A., Boring, S. & Greenberg, S., 2011. Body-centric Interactions. *Body-Centric Interaction: Using the Body as an Extended*, pp. 1-2.
- Gemperle, F. et al., 1998. Abstract. *Design for Wearability*, p. 1.
- Gemperle, F. et al., 1998. Design Guidelines for Wear-ability. *Design for Wearability*, p. 2.

- Gongini, B. i., 2017. *SUSTAINABLE FASHION STARTS WITH ETHICS & DESIGN*. [Online]
 Available at: <https://barbaraigongini.com/universe/blog/sustainable-fashion-design/>
 [Accessed 24 October 2018].
- Gong, M., 2014. Transformable Design. *SUSTAINABLE FASHION DESIGN: TRANSFORMABLE GARMENTS FOR VERSATILITY AND LONGEVITY*, pp. 3-4.
- Gong, M. & Rahman, O., 2016. Abstract. *Sustainable practices and transformable fashion design – Chinese professional and consumer perspectives*, 9(3), pp. 1-2.
- Huynh, C., 2018. *The Ultimate Guide to Ethical Jewellery*. [Online]
 Available at: <https://goodonyou.eco/the-ultimate-guide-to-ethical-jewellery/>
 [Accessed 25 October 2018].
- Joy, A. et al., 2012. Introduction. *Fast Fashion, Sustainability, and the Ethical Appeal of Luxury Brands*, 16(3), p. 274.
- Leblanc, R., 2018. *About Metal Recycling - An Introduction to Scrap Metal Recycling*. [Online]
 Available at: <https://www.thebalancesmb.com/about-metal-recycling-2877921>
 [Accessed 25 October 2018].
- Lejeune, T., 2018. *Fast Fashion: Can It Be Sustainable?*. [Online]
 Available at: <https://www.commonobjective.co/article/fast-fashion-can-it-be-sustainable>
- Lo, F., 2017. *Mindless Overconsumption Is Destroying You and the Planet*. [Online]
 Available at: <https://www.ecowatch.com/overconsumption-fast-fashion-2399956999.html>
 [Accessed 22 October 2018].
- Peter, J., 2018. *Transformable Fashion: The Biggest Sustainable Clothing Trend That Never Wa*. [Online]
 Available at: <http://www.fashionstudiesjournal.org/commentary/2018/9/15/transformable-fashion>
 [Accessed 26 October 2018].
- Salari, G., 2017. *Fast Fashion Wrecks the Environment: Here Are 3 Ways to Slow It Down*. [Online]
 Available at: <https://www.ecowatch.com/pioneering-brands-fast-fashion-2494799380.html>

Samarawickrama, Sumanthri, et al (eds), 2018, "Sustainability for people - envisaging multi disciplinary solution": *Proceedings of the 11th International Conference of Faculty of Architecture Research Unit (FARU), University of Moratuwa, Sri Lanka, December 08, 2018* Galle pp. 147–154. ©

INFLUENCE OF ORGANISATIONAL CULTURE ON KNOWLEDGE MANAGEMENT IN A BIM ENABLED ENVIRONMENT

TENNAKOON T.M.M.P.¹, WIJEWICKRAMA M.K.C.S.², KULATUNGA U.³ & JAYASENA H.S.⁴

Department of Building Economics, University of Moratuwa, Sri Lanka

¹mptennakoon@gmail.com, ²mkcsw.mora@gmail.com, ³udayangani2002@yahoo.com, ⁴suranga.net@gmail.com

Abstract

Knowledge Management (KM) is increasingly recognized as a flourishing discipline within the Architecture, Engineering, Construction and Operation (AECO) industry as the rapid change in the industry can only be handled through a coherent approach to KM. The enriched information and communication technologies such as Building Information Modelling (BIM) and responded soft issues as culture, people and work environment are the main approaches to KM. Hence, the research is directed at the cultural influence on the KM in a BIM based environment to embed the individual's knowledge in projects to increasing organisational cohesion and performance. A comprehensive literature analysis was conducted on currently available scientific knowledge in reliable sources such as indexed scientific journals, conferences, edited books and the most congruent facts were constructed in a logical order to realise the influence of organisational culture on KM in a BIM enabled environment compared to a traditional construction environment. It was established that construction project activities are knowledge incentive and knowledge could be stored in databases commonly known as Knowledge Management Systems (KMS), once the subject experts validate it. The implementation of a suitable organisational culture, where knowledge sharing, shared learning and collaboration were entrenched, was acknowledged as essential to KM.

Keywords: *Building Information Modelling (BIM); Knowledge Management (KM), Organisational Culture.*

1. Introduction

Construction project activities are knowledge incentive and it has encouraged the construction organizations to manage knowledge effectively and efficiently. Lin (2014) emphasized that the involved engineers and the experts in AECO industries can share and reuse their knowledge to improve the construction process cost relating issues and the time escalations.

Queries has been raised about the current KM in practice due to the limitations to the physical and knowledge infrastructure since knowledge is not treated as an asset and is only shared informally among staff through tips or lessons learned in organisations (Succar, 2015).

Nevertheless, arguments against the AECO industries are contended by Brewer and Gajendran (2011) stating that the industry has been evolved with Information and Communication Technology, which provides a variety of technical solutions to standardize and rationalize the process of design, construction and operation of built assets. Within this context, modern technologies such as BIM facilitate KM implementation. According to Succar (2015), the emergent technical and procedural shift in the AECO industries has been accelerated through BIM.

Yet, most of the expensive software implementations, critically inconsistent as they are not customized according to the strategic orientation and the personnel interaction within the particular industry because the culture is overlooked (Beckett et al., 2000). According to Construction Industry Council BIM Protocol (2013), a strong culture facilitates achievement of objectives. For an instance, the requirement of a separate electronic data exchange agreements among members of the project team is seized by removing the primary risks in relation to the provision of electronic data corruption by improving the trust base of the culture (Bouazza, Udeaja, & Greenwood, 2015).

Therefore, the significance of BIM as a multidisciplinary implementation to integrate the processes in the concept, design, construction, and operation stages of the construction projects have been highlighted in this study in relation to the influence of organisational culture on KM.

2. Knowledge Management

A well-established definition for knowledge is that it is “justified true belief” (Nonaka & Takeuchi 1995, p. 87). It has been elaborated as a condition or point of knowing where knowledge formulated through understanding gain through study or experience, perceived or discovered (Schubert & Selz, 2013, p. 618-620).

Subsequently, Lin (2014) has expressed KM as the organization, creation and the transferring of knowledge while BIM being the platform of visual knowledge retrieval and sharing. The earliest authors, Nonaka and Takeuchi (1995), and Dalkar (2011) have possessed and presented similar opinion, that KM was an organizationally and systematically definite process of sharing, transferring, creating using and storing knowledge of employee to enhance organizational performance.

2.1 KNOWLEDGE MANAGEMENT IN TRADITIONAL CONSTRUCTION ENVIRONMENT

Construction project activities are knowledge incentive and it has lead the construction organizations to manage information and knowledge more effectively and efficiently. Lin (2014) highlighted that the engineers and the experts can share and reuse their knowledge to improve the construction process cost relating issues and the time escalations.

Moreover, the transfer of organisational knowledge across projects facilitates the opportunity to exploit and leverage the invaluable lessons learned and avoidance of repetitive mistakes in a project base setting. In 2008, Kivrak, Arslan, Dikman, and Birgonul conducted a survey-based research to investigate the tactic and explicit knowledge captured, shared, used and stored for the future use for the coming projects and major barriers and drivers of KM.

Nevertheless, in order to solve the knowledge sharing problems within construction organizations, research had been carried out to implement a web-based KMS). Zang, Mao and Abourisk (2009) had proposed a value engineering KMS expecting a more organized, systematic and problem focused designing stage to construction projects.

2.2 KNOWLEDGE MANAGEMENT PROCESS MODEL

The knowledge in the AECO industries had been utilized with different perceptions. The need for innovative KMS, change and best practice in the industry have been highlighted where KM is known to be a major constituent. International Organization for Standardization (ISO, 2016) has identified the Knowledge Management Process Model (See Figure 1) by Botha, Kourie, and Snyman (2008) in ISO 9001:2015 Clause 7.1.6 (*Knowledge Management*) for its practicability and simplicity.

It distinguishes people focused and technological oriented management processes. Knowledge creation, sensing, organizing and capturing were considered as human focus steps and knowledge sharing and dissemination as technology focus steps (Botha et al., 2008).

3. Building Information Modelling (BIM)

In AEC UK BIM Protocol (2013), BIM was defined as “the creation and use of coordinated, internally consistent, computable information about a project in design and construction” (p.7). Further, it is elaborated by Succar (2015) as a set of processes, technologies and policies allowing integrated design, construct and operation to the different stakeholders.

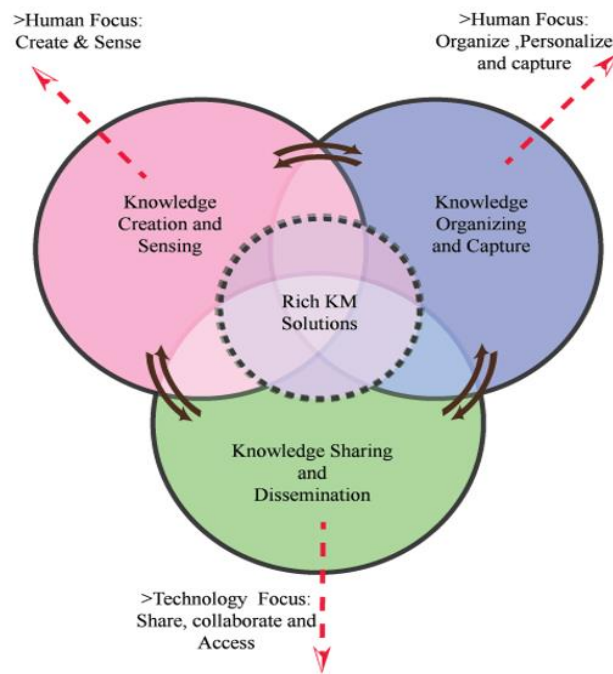

Figure 1: Knowledge Management Process Model
 Source: (Adapted from Botha et al.,2008)

3.1 APPLICATION OF BIM FOR KM SOLUTIONS

The facilitating BIM characteristics for achieving sustainability through KM has been identified in the Table 1. The availability of a central database, ability to add for industry specific applications and collaboration are the main features. Since, knowledge creation, sensing, knowledge organisation, and capturing are human focused KM features, the sustainable solutions for KM and AECO disciplinary is achievable by integrating the different professional knowledge through BIM.

Table 1: BIM Characteristics Facilitating the KM Process

KM feature	Reference	Facilitating BIM feature	Reference
Knowledge creation and sensing	Botha et.al,2008	Data and information of model can be stored in databases to facilitate collaboration	Lin,2014
Knowledge organizing and capturing	Botha et. al,2008	Changes to these data bases can be managed such that a change in the data base affects all the part of model	Lin, 2014
Knowledge sharing and dissemination	Botha et al, 2008	The information model can be captured and preserved for reuse by adding industry specific applications	Lin, 2014

Thus, it is evident that BIM has characteristics, which are required to implement effective KM solutions. Similarly, In this context, the cultural influence is significant to establish the connection among people and the technology.

4. Organisational Culture

The organizational culture is widely considered as the most important impediment to the transfer and management of the knowledge (Ajmal & Koskinen, 2008). The most denoted definition for the organizational culture had been provided by Schein (2004) as, “a pattern of shared basic assumptions, which is learned by a group as it solve problems of external adoption and internal integration. Since, they worked well enough to be considered valid and, they are taught to new members as the correct way to perceive, think, and feel in relating to those problems.” In the latest studies, Schien and Dawsonera (2010) distinguished the key cultural elements; artifacts, basic assumptions, and espoused values.

4.1 ORGANISATIONAL CULTURE IN TRADITIONAL CONSTRUCTION INDUSTRY

Matinaro and Liu (2017) argue that lack of cultural management in the AECO industries hinders innovativeness. However, responses to many other external factors are influenced by the culture in traditional construction environments in construction organisations. Arditi, Nayak, and Damci (2017) instated that it surpassed the factors such as market presence, corporate strategy and technological advancement.

The culture was viewed as a commanding resource of common identity, organisational purpose flexible guidelines (Ahmady et al., 2016) which reflected about projects and time to communicate the output inside and outside the teams (Mueller, 2014).

4.2 ROLE OF ORGANISATIONAL CULTURE TOWARDS KM

Haqiqat-Monfared and Hooshyar (2010) have emphasized that a suitable organizational culture is one of the most significant factors for a successful management of knowledge activities. Similarly, Mueller (2014) has highlighted, the major manifestations of the culture as trust, collegiality, output oriented evaluation, openness and high learning orientation, which influence knowledge sharing.

Kathiravelu et al. (2014) has stated that managers' commitment, emotional intelligence, fear, the presence of hierarchy in the organizational structure, shortage of resources, conflict of motives, lack of social network, uncertainty, under estimation of lower levels, conflict avoidance and the general environment at work were factors that had influence on KM.

5. Findings and Discussion

The findings of the study is based on a comprehensive literature synthesis on currently available scientific knowledge in reliable sources such as indexed and non-indexed scientific journals, indexed conferences, edited text books were thoroughly investigated and the most congruent facts were constructed in a logical order to feature the research gap. The lack of availability of BIM implemented projects in the local context limited the study to a literature review. A case study approach might have facilitated an in-depth study of the organisational culture, yet the result would not expedient to generalize for the context, which is one of the objective of the study. However, the cultural factors that has been considered in the study are inherent to any construction organisation in the local context. Thus, the result from the study is justifiable to any construction organisation.

5.1 INFLUENCE FROM ORGANISATIONAL CULTURAL FACTORS ON KM IN TRADITIONAL CONSTRUCTION ENVIRONMENT

As elaborated by Ahmady et al. (2016), Professor Daniel Denison considered cultural properties of an innovative and effective organizational culture under 12 factors. The Table 2 recognizes these cultural factors and their influence on KM in traditional construction environment. These factors indicate the influence on KM considering the main three areas explained in Knowledge Management Process Model.

Table 2: Cultural Factors and the influence of them on KM in a traditional construction environment.

Mission		
Strategic direction and intent	Organisational purpose on which the individuals act upon in long term. The plans and other statements about the desired future directions of organization, which include the KM directives, and the use of KM in decision-making.	Haqiqat-Monfared&Hooshyar,2010; Mantere & Sillince, 2007
Goal and objective	Purposes integrated with strategy and vision of an organization. Reflect the strategy to adopt learning culture or enhance knowledge creation through education, mentoring and training which in return enhance the organisation performance by improving the employees' engagement and commitment.	Abubakar, Elrehail, Alatailat, & Elçi, 2017; Shafee et al., 2010

Outlook	The vision about the future, forming core values of the entity. Developing a strong vision and adaptability of the employees to that conceptualization enhance the occurrence of effective knowledge creation, knowledge sharing, external knowledge acquisition and knowledge documentation.	Haqiqat-Monfared&Hooshyar,2010 ; Younis, 2013
Compatibility		
Core value	A set of values forming identity and expectations of an organisation, which define for uniformities in behavior. The strategic thinking of use of cognitive surplus in opportunities through the strategic alignment of KM.	Imani,2012
Agreement	The method of stakeholders come to agreement in a conflict. Due to the different knowledge build up through different norms, people agree in different issues. Include agreement with managerial level and the subordinate level	Angouri & Locher, 2012; Metaxiotis, Ergazakis, & Psarras, 2005
Coordination and integration	Willingness to integrate operations with the other project stakeholders. Include the collaborative working of the employees in knowledge sharing, mentoring, and creation of knowledge especially in changing environment.	Imani,2012
Involvement		
Empowerment	An active motivation-oriented characteristic creating a possessive and responsible sense of one's work which, mediates to the relationship between technology and knowledge seeking. Increase the knowledge contribution and knowledge sharing.	Imani, 2012 ; Kang, Lee, & Kim, 2017
Group orientation	Group work to achieve a common purpose in conditions where using the integrated knowledge in the group is beneficial than spending time seeking information beyond group boundaries.	Haqiqat-Monfared & Hooshyar,2010;
Capability development	Providing skills and needs to perform in the competitive arena. Capability development in terms of expertise knowledge which gains through formal education and experience, documentation of knowledge by repository support for clarity of meta data, standardization, comprehensiveness of taxonomies.	Demchig, 2015, Imani, 2012
Adaptability		
Creating change	Respond to need through taking innovative actions. The continuous refining of organisational knowledge leads to the need of change. The change process directly intervened with knowledge where first the non-confirmed data create imbalance, then the connection of the change to the existing knowledge ideals and finally psychological comfort through the full knowledge of change.	Gamble & Blackwell ,2001; Haqiqat-Monfared&Hooshyar,2010; Heier & Strahinger, 2006
Customer focus	The level of focus on the final output than on the process. The knowledge on the perceptions of customers leads to be more output focused than the construction process.	Shafee et al., 2010; Walker, 2000
Organisational learning	The level of the motivation to learn through mistakes. Generation of new knowledge at a speed to create new ideas, untried solutions and proposals which enable the sustainability in the long run. Transform knowledge in the environment to core residual knowledge.	Imani, 2012 ; Mishra & Bhaskar, 2011

The tables introduce the organisational cultural factors considered with in a traditional construction environment while explaining the influence of the cultural factors on KM.

5.2 INFLUENCE OF ORGANISATIONAL CULTURE ON KM IN A BIM ENABLED ENVIRONMENT COMPARED TO TRADITIONAL ENVIRONMENT.

Alternatively, the Table 3 demonstrates the summary of the literature synthesis, which provides the influence of the 12 cultural factors on KM in a BIM, enabled environment.

Table 3: Influence of the 12 Cultural Factors on KM in a BIM Enabled Construction Environment

Mission		
Strategic direction and intent	There is a necessity to take a step backward to understand how to combine BIM technology to KM via the organizational strategy. The strategic direction and intent is directly associated with the future directions of the organisation, which may include KM directives, BIM directives and long-term sustainability in construction.	Kapogiannis & Sherratt ,2018; Manthere and Sillince (2007),

Goal and objective	Knowledge creation, capturing and sharing through a KMS may be reflective through the goals and objectives, but the nature of tacit knowledge causes limitations in the objectivist KM in construction in BIM environment.	Addis (2016)
Outlook	KM can easily be incorporated to the strategy if BIM or technological use is within the outlook of the organization. Yet, the disinterest to develop long-term relationship with trading partners to adapt return of significant investment is an issue when considering investing in BIM	Motamedi, Hammad, & Asen, 2014
Compatibility		
Core value	Knowledge in a perspective of a “state of mind”, which involved upgrading the user learning and understanding through provisions of information and therefore, using BIM is encouraged for KM considering the benefits to individuals and organisation.	Alavi and Leidner, 2011
Agreement	The lack of standard conditions of contact that specifically address the conflicts raised by use of ICT. The need of guidelines, frameworks and tools that allowed the AECO industries to shape its culture to integrate the human aspects in the dynamic environment of advance technologies is explicit.	Fong & Kwok,2009; Trigunarsyah, 2017
Coordination and integration	The practice of using multiple online systems introduced by the different project participants may strongly established in the culture, which make it easier to use BIM for KM and the coordination and integration among different disciplinary will be facilitated through federated and central BIM models	Motamedi, Hammad, & Asen, 2014
Involvement		
Empowerment	The knowledge creation, organisation and sharing is facilitated through BIM, addressing fragmented issues in the project team to improve performance related to The infringement of the transparency and trust among the project team members. BIM implementation utilize knowledge for better scheduling improved to JIT deliveries, coordinating the as built models to asset information models, soft landing or any other knowledgeable forecasting activities using the BIM models as a pioneering tool for visualizing construction process.	Brewer &Gajendran,2011; Ding, Zhou, Lou, & Wu ,2012 ; Trigunarsyah, 2017
Group orientation	Stakeholders from different disciplinary backgrounds such as designers, contractors, quantity surveyors and facility managers may had different usage patterns, which necessitated different standard interfaces in BIM, yet it collaborate these direct stakeholders together by model simulations. BIM influenced the deployment of a collaborative culture during all stages of the project, which in return share tacit knowledge among group members.	Kapogiannis &Sherratt ,2018; Singh et al., 2011
Capability development	The cultural values to be adopted by the AECO industries were similar to the desired cultural values for an ICT facilitating optimised environment, thus capabilities regarding technology, and human are developed when BIM is implemented as stated in the knowledge management process model	Botha et al., 2008; Brewer &Gajendran,2011
Adaptability		
Creating change	Lack of cultural management in the AECO industries hinders innovative change. Thus, BIM is resisted within the industry. Nevertheless, BIM can be integrated into construction SC to promote information flow and KM between the stakeholders throughout the construction project life cycle.	Konukcu & Koseoglu, 2012 ; Matinaro & Liu ,2017
Customer focus	Literature conceptual framework of Knowledge-based BIM (K-BIM) combining BIM, KM, and facility management ontologies to aid the effective management of facilities by with the focus on customer. Similarly, the BIM model enable visualization of the performance analysis of the project.	Alshawi, 2015 ; Charlseraj,2014
Organisational learning	Constructability analysis, future business case analysis and cost analysis, which contributed with embedded knowledge to make informed decisions using BIM model are outcomes of KM where knowledge should be effectively managed to the continued advancement.	Alshawi, 2015Park, Lee, and Kwon ,2010

When comparing the content of the Table 2 and Table 3, a clear notion can be explicated, regarding their influence in BIM enabled environment and a traditional environment. There are arguable cultural factors as agreement, core value, which suggest a weak influence on KM in a BIM, enabled environment whereas other factors have a significant influence on KM in BIM environment compared to traditional environment.

5. Conclusion

The AECO industries has been evolved with ICT, which provide a variety of technical solutions to standardize and rationalize the process of designing, constructing and operating of built assets. The emergent technical and procedural shift has been accelerated in the AECO industries through BIM. According to the findings the cultural factors such as coordination and integration, empowerment and organisational learning, strongly influence the KM in a BIM enabled environment when compared to their influence in traditional construction environment.

6. References

- Abubakar, A., Elrehail, H., Alatailat, M., & Elçi, A. (2017). Knowledge management, decision-making style and organizational performance. *Journal of Innovation & Knowledge*.
- AEC (UK) BIM Protocol Implementing UK BIM Standards for the Architectural, Engineering and Construction industry (2012, September). Version 2.0 for Revit and Bentley Building. Available at <https://aecuk.files.wordpress.com/2012/09/aecukbimprotocol-v2-0.pdf>
- Addis, M. (2016). Tacit and explicit knowledge in construction management. *Construction Management and Economics*, 34(7-8), 439-445.
- Ahmady, G., Nikooravesh, A., & Mehrpour, M. (2016). Effect of Organizational culture on knowledge management based on Denison Model. *Procedia - Social and Behavioral Sciences*, 230, 387-395.
- Ajmal, M., & Koskinen, K. (2008). Knowledge transfer in project-based organizations: An organizational culture perspective. *Project Management Journal*, 39(1), 7-15.
- Alavi, M., & Leidner, D. (2011). Review: Knowledge Management and Knowledge Management Systems: Conceptual Foundations and Research Issues. *MIS Quarterly*, 25(1), 107.
- Alshawi, M. (2015). BIM for client organisations: a continuous improvement approach. *Construction Innovation*, 15(4), 402-408.
- Arditi, D., Nayak, S., & Damci, A. (2017). Effect of organizational culture on delay in construction. *International Journal of Project Management*, 35(2), 136-147.
- Beckett, A., Charles, E., & Bance, D. (2000). Knowledge management strategy or software. *Management Decision*, 38(9), 601-606.
- Botha A, Kourie D, & Snyman R, (2008), *Coping with Continuous Change in the Business Environment, Knowledge Management and Knowledge Management Technology*, Chandice Publishing Ltd.
- Bouazza, T., Udeaja, C., & Greenwood, D. (2015). The use of building information modelling (BIM) in managing knowledge in construction project delivery: a conceptual model. *Building Information Modelling (BIM) in Design, Construction and Operations*.
- Brewer, G., & Gajendran, T. (2011). Building Information Modelling and the culture of construction project teams: A case study. *Management and Innovation for a Sustainable Built Environment MISBE 2011*. Amsterdam: CIB.
- Construction Industry Council BIM Protocol. (2013, February). Available at https://www.google.lk/url?sa=t&rct=j&q=&src=s&source=web&cd=1&cad=rja&uact=8&ved=0CBwQFjAA&url=http%3A%2F%2Fdic.org.uk%2Fdownload.php%3F%3Dthe-bim-protocol.pdf&ei=XkMvVb3OL8_qaKaogOgN&usq=AFQjCNFidb5EChOC47YSpT_4yWExy7hocQ&bvm=bv.91071109,d.bGQ
- Dalker, K (2011). *Knowledge Management in Theory and Practice* (2nd ed.). The MIT Press
- Demchig, B. (2015). Knowledge Management Capability Level Assessment of the Higher Education Institutions: Case Study from Mongolia. *Procedia - Social and Behavioral Sciences*, 174, 3633-3640.
- Ding, L., Zhou, Y., Luo, H., & Wu, X. (2012). Using nD technology to develop an integrated construction management system for city rail transit construction. *Automation in Construction*, 21, 64-73.
- Fong, P., & Kwok, C. (2009). Organizational Culture and Knowledge Management Success at Project and Organizational Levels in Contracting Firms. *Journal of Construction Engineering and Management*, 135(12), 1348-1356.
- Gamble, P., & Blackwell, J. (2001). *Knowledge Management: A State of the Art Guide*. London, United Kingdom: Kogan Page.
- Haddadi, A., Hosseini, A., Johansen, A., & Olsson, N. (2017). Pursuing Value Creation in Construction by Research -A Study of Applied Research Methodologies. *Procedia Computer Science*, 121, 1080-1087.
- Haqiqat-Monfared, J., & Hooshyar, A. (2010). Investigating relation without organizational culture and knowledge management: case study, Oil Company of Iran. *Quarterly journal of Scientific-research management and human source in petroleum*, 4(11).
- Heier, H., & Strahringer, S. (2006). Knowledge Management Systems and Organizational Change Management: The Case of Siemens ShareNet. *Practical Aspects of Knowledge Management*, 97-105.
- Imani, R. (2012). Creativity, innovation and knowledge: power pilots in new millennium with attitude to knowledge –based economy. Tehran (Iran): ZArinmehr. *Journal of Knowledge Management*, 6(1)
- International Organisation for Standardisation (2016) ,ISO 9001:2015 Quality Management, Available at <https://www.iso.org/iso-9001-quality-management.html>
- Kapogiannis, G., & Sherratt, F. (2018). Impact of integrated collaborative technologies to form a collaborative culture in construction projects. *Built Environment Project and Asset Management*, 8(1), 24-38.
- Kathiravelu, S., Mansor, N., T.Ramayah, & Idris, N. (2014). Why Organisational Culture Drives Knowledge Sharing? *Procedia - Social and Behavioral Sciences*, 129, 119-126.
- Kivrak, S., Arslan, G., Dikmen, I., & Birgonul, M. T. (2008). Capturing Knowledge in Construction Projects: Knowledge Platform for Contractors. *Journal of Management in Engineering*, 24(2), 87-95.
- Konukcu, S., Koseoglu, O. (2012). *Proceedings of The 29th International Conference: Knowledge Management Through BIM in Construction Supply Chains*. Beirut, Lebanon

- Lin, Y. (2014). Construction 3D BIM-based knowledge management system: a case study. *Journal of Civil Engineering and Management*, 20(2), 186-200.
- Mantere, S., & Sillince, J. A. (2007). Strategic intent as a rhetorical device. *Scandinavian Journal of Management*, 23(4), 406-423.
- Matinaro, V., & Liu, Y. (2017). Towards increased innovativeness and sustainability through organizational culture: A case study of a Finnish construction business. *Journal of Cleaner Production*, 142, 3184-3193.
- Metaxiotis, K., Ergazakis, K., & Psarras, J. (2005). Exploring the world of knowledge management: agreements and disagreements in the academic/practitioner community. *Journal of Knowledge Management*, 9(2), 6-18.
- Motamedi, A., Hammad, A., & Asen, Y. (2014). Knowledge-assisted BIM-based visual analytics for failure root cause detection in facilities management. *Automation in Construction*, 43, 73-83.
- Mishra, B., & Uday Bhaskar, A. (2011). Knowledge management process in two learning organisations. *Journal of Knowledge Management*, 15(2), 344-359.
- Mueller, J. (2014). A specific knowledge culture: Cultural antecedents for knowledge sharing between project teams. *European Management Journal*, 32(2), 190-202.
- Nonaka, I., Takeuchi, H. (1995) *The knowledge-creating company. How Japanese companies create the dynamics of innovation*, Oxford University Press, Oxford.
- Park, M.; Lee, H. S.; Kwon, S. 2010. Construction knowledge evaluation using expert index. *Journal of Civil Engineering and Management* 16(3): 401-411.
- Rezgui, Y., Beach, T., & Rana, O. (2013). A governance approach for BIM management across lifecycle and supply chains using mixed-modes of information delivery. *Journal of Civil Engineering and Management*, 19(2), 239-258.
- Salman, A. (2011, July 01). Building Information Modelin (BIM): Trends, benefits, risks, and challenges for the AEC industry. *Leadership and Management in Engineering*, 11(3), 241-252. doi:10.1061/(ASCE)LM.1943-5630.0000127
- Schien, E. H. (2004). *Organizational culture and leadership* (3rd ed.). Jossey-Bass.
- Schein, E., & Dawsonera. (2010). *Organizational culture and leadership* (4th ed.). San Francisco, Calif: Jossey-Bass.
- Schubert, P., & Selz, D. (2013). Organizational design of an IT-based knowledge system: the NetAcademy concept. *Proceedings of the Thirty-First Hawaii International Conference on System Sciences*.
- Shafee, R., Qaderzade, H., & Lavee, H. (2010). *Proceedings of Second International Conference of Management Innovation: Investigating the effect of organizational culture dimensions on establishing knowledge management in public organization based on Denison model*. Shiraz.
- Singh, V., Gu, N., & Wang, X. (2011). A theoretical framework of a BIM-based multi-disciplinary collaboration platform. *Automation in Construction*, 20(2), 134-144.
- Succar, B. (2015, 06). <http://www.changeagents.com.au/>. Retrieved from http://bimexcellence.com: http://changeagents.blogs.com/Public_Sharing/BIM%20Maturity%20Matrix%20-%20Organizational%20Discovery.pdf
- Trigunarsyah, B. (2017). Organizational culture influence on client involvement. *Engineering, Construction and Architectural Management*, 24(6), 1155-1169. doi:10.1108/ecam-06-2016-0141
- Walker, D.(2000). Client/customer or stakeholder focus? ISO 14000 EMS as a construction industry case study. *The TQM Magazine*, 12(1), 18-26. doi:10.1108/09544780010287221
- Woolley, A., Bear, J., Chang, J., & De Costanza, A. (2013). The effects of team strategic orientation on team process and information search. *Organizational Behavior and Human Decision Processes*, 122(2), 114-126.
- Younis, T. S. (2013). Strategic vision to knowledge management strategy: An evaluative paradigm. *World Sustainable Development Outlook 2007: Knowledge Management and Sustainabl*, 86-93.
- Zhang, X., Mao, X., & AbouRizk, S. M. (2009). Developing a knowledge management system for improved value engineering practices in the construction industry. *Automation in Construction*, 18(6), 777-789.

Samarawickrama, Sumanthri, et al (eds), 2018, "Sustainability for people - envisaging multi disciplinary solution": *Proceedings of the 11th International Conference of Faculty of Architecture Research Unit (FARU), University of Moratuwa, Sri Lanka, December 08, 2018* Galle pp. 155–164. ©

PRESENT TRENDS IN INCOME AND ITS IMPACT ON AFFORDABILITY OF MULTI-OWNERSHIP HOUSING

NAYNA TABASSUM¹ & SIMITA ROY²

^{1,2}Department of Architecture, Bangladesh University of Engineering and Technology (BUET), Dhaka, Bangladesh.

¹nayna.arch@gmail.com, ¹nayna@arch.buet.ac.bd, ²simita.arch@gmail.com

Abstract

In accordance with the continuous urbanization of Dhaka city- the capital of Bangladesh, rural people are highly allured by its development of utility and facilitation. The increased rural-urban inflow has made Dhaka one of the top most densely populated cities of the world. One of the major challenges faced by the city is to address the housing demand of this increased population within their affordability. In facing up such challenges and targets, multi-ownership has emerged as the only viable option to avail ownership of housing. The objective of this paper is to find out the comprehensive scenario of current income trend and its impact on affordability of housing which are multi-ownership in nature. The discourse consists of analyzing the current income trend and affordability of target population through a questionnaire survey and case studies. Multiple cases has been selected from two different study areas of two distinct city corporations of Dhaka; one is from Southern part - Khilgaon and another one is from northern part – Matikata. Both the areas are mostly residential in nature and have similar growth pattern. Finally the end result is derived by comparative analysis of all the data of the case studies denoting the income trend with ownership pattern. The research result illustrates the contemporary manifestation of multi-ownership housing faucet.

Keywords: *Affordable housing, income trend, multi-ownership housing, housing finance, economic sustainability.*

1. Introduction

Housing is a basic civic right to every citizen. Housing depends on various factors from the policy to physical housing delivery. Affordability is one of the major issues for housing to reach the target group. Dhaka is under accelerated pressure of the housing from migration rate. Along with this need, the real estate market has also seen a boom due to the adaptive nature of financing market. If we see the current scenario of housing market, we can find price hike in land, materials, infrastructure which actually affects the affordability of housing. Many researchers tried to find out the driving forces for this price hike in housing. For example Li (2008) and Lau and Li (2006) suggested that housing affordability problem was mainly driven by housing supply and demand. Some studies attributed housing affordability problem to some inappropriate government housing policies. Income inequality and demographic characteristics also put an impact on housing price. To satisfy this issue the government and financing market are continuously working. The government has increased its pay scale almost double in the recent year. As a result, the relation between dwelling unit and household income has changed, so the affordability of housing has shifted too.

2. Aim, Objective and Limitations

The aim of the research is to find out the present income trend with an increase in pay scale and its direct impact on housing affordability.

The major objective of this paper is to compare the affordable housing conditions in two different areas, Matikata, from Dhaka North City Corporation (DNCC) & Khilgaon, from Dhaka South City Corporation (DSCC) and investigate the shift in relation between household income and housing unit price and figure out the affordability spectrum in the study areas.

One of the major limitations of this paper is inadequacy of survey sample. A little larger sample number may make the data collected and analyzed more acceptable.

3. Literature Review

Rapid population growth and territorial expansion are the major characteristics of Dhaka just like many other cities of any developing countries. The gap between housing supply and demand is widening in developing countries and during the early 1980s nine new households were formed for each permanent dwelling built in such countries or in other words, one housing unit against 9 newly formed households (Chowdhury, 2013; World Bank, 1998; Brennan, 1993). It has been acknowledged by many researchers that affordable housing is not a problem only for the poor but also for the middle and low-income groups in most of the developing countries.

Countries like Singapore, Hong Kong, China etc. have already reached milestones in these phenomena of multi-ownership housing. Though it has been a very recent trend in Bangladesh as for many years people were living with the concept of private ownership of land and house with some rentable apartments. As such, cities are now facing newer and newer challenge in housing sector.

3.1. MULTI-OWNERSHIP HOUSING

Multifamily residential (also known as multi dwelling unit) is a classification of housing where multiple separate housing units for residential inhabitants are contained with one building or several buildings within one complex. A common form is flat apartment housing. Housing is not just a mere shelter, but it is a place where a family lives and it plays a comprehensive role as far as socio-economic state of the family concerned. There is no doubt that the standard of accommodation offered by a flat or apartment is interior to the separate cottage or detached house. Due to the characteristics features of a flat according the accommodation no single dwelling unit is self-sufficient in access, vertical circulation, service features and structural identity. These features necessitate the need for greater sociability and preserving certain restriction on some activities that might cause inconveniences to the other dwellers.

3.2. AFFORDABILITY OF HOUSING AND AFFORDABLE HOUSING

Affordability of housing reflects how easy or difficult it is to rent or buy property (wikipedia.org). Affordability of housing is generally determined by income trend of the society or a particular family. The gap between monthly income and expenditure that is monthly savings play a significant role in affordability of housing.

On the other hand 'Affordable Housing' is housing that is appropriate for the needs of a range of very low to moderate income households and priced so that these households are also able to meet other basic living costs such as food, clothing, transport, medical care and education. As a rule of thumb, housing is usually considered affordable if it costs less than 30 percent of gross household income (nsw.gov).

3.3. HOUSING AFFORDABILITY INDEX

The Housing Affordability Index measures whether or not a typical family earns enough income to qualify for a mortgage loan on a typical home at the national and regional levels based on the most recent price and income data. The Monthly Housing Affordability Index measures whether or not a typical family earns enough income to qualify for a mortgage loan on a typical home at the national and regional levels based on the most recent monthly price and income data (nar.realtor).

3.4. INCOME TREND

The Household Income and Expenditure Survey (HEIS) 2010 and similar surveys undertaken in 2010-2011 by Bangladesh Bureau of Statistics (BBS) have published the distribution of income and expenditure both for urban and rural population and also for national level. No specific data is available for Dhaka city. It is apprehended that income were understated by the respondents and following the practice of other researchers, the household expenditure is also used as the basis of analysis.

4. Methodology

This paper particularly focuses on first hand data collected from the study areas, Matikata and Khilgaon by questionnaire survey and interview. Total 6 house-holds from each study area are surveyed. Each of

the houses has different contextual situation like their building time period, ownership, characteristics etc. After the data collection all the information is sort out and analyzed. Data are analyzed on the basis of income and expenditure trend keeping in mind the issue of affordability. Finally the end result is derived by comparative analysis of all the data of the case studies.

5. The Study Area

The Matikata area is situated in Mirpur Cantonment area (ward no.-15, Dhaka).It was a low lying area, basically wetland. There were a few number of families lived in this area. The infrastructure quality of the road is not so good like other higher areas i.e. Dhanmandi, Mohammadpur or Mirpur. As such, the land value is comparatively low than other areas of Dhaka, which is acting like a privilege to the investors of middle income group. So, in this area, the current housing trend is rental (because of low rental amount) and co-operative housing based on the ownership.



Figure 1, Matikata Area, Dhaka (Source: Author)

Khilgaon area is situated near the central business district (CBD) Motijheel area comprising ward no 1,zone 2 under Khilgaon thana. Previously it was a low lying wetland area. Government took a rehabilitation project for the affected people due to establishing the *Kamapalapur Railway Station*. At that time Khilgaon area was developed as a small scale planned residential area. The infrastructure quality is good. But because of the low lying area water logging can cause a problem at the time of heavy rain and flooding. Land price is comparatively low in this area and so the house rent is lower than other areas of northern part of Dhaka city.

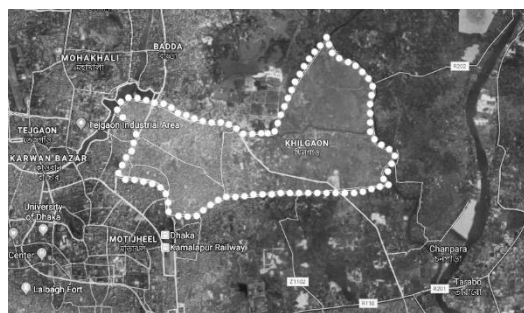

Figure 2, Khilgaon Area, Dhaka (Source: Author)

6. Case Study Detail

In total 12 (twelve) cases has been taken, 6 (six) from each area, for the survey. Six families from different buildings have been taken under consideration for the study. The details are being provided here for understanding the current income trend and its impact on affordability of multi-ownership housing.

6.1. INCOME & EXPENDITURE

Table 1(a): Monthly income and expenditure (Matikata)

	Monthly household income				Family size	Earning member	No. of flat owned	Expenditure (tk)	Savings (tk)	% of savings
	Salary (tk)	Flat rent (tk)	Others (tk)	2 nd earning member (tk)						
1	130,000				03	01	01	80,000	50,000	38.46%
2	90,000	12,000			04	01	02	70,000	32,000	35.56%
3	110,000				04	01	01	50,000	60,400	54.54%
4	55,000		10,000		03	01	01	45,000	19,400	29.85%
5	55,000			38,000	03	02	01	55,000	50,400	53.76%
6	55,000	10,500	40,000		03	01	02+01 under const.	100,000	100,000	50%

Table 1(b): Monthly income and expenditure (Khilgaon)

	Monthly household income				Family size	Earning member	No. of flat owned	Expenditure (tk)	Savings (tk)	% of savings
	Salary (tk)	Flat rent (tk)	Others (tk)	2 nd earning member (tk)						
1		70,000			05	01	01	50,000	20,000	28%
2			35,000		03	01	01	30,000	5,000	14%
3	110,000				04	01	01+01 under const.	100,000	10,400	9%
4	80,000				04	01	01	65,000	15,000	18.75%
5	50,000				03	01	01	40,000	10,400	20%
6	65,000			20,000	05	02	02	70,000	15,000	17.5%

From table – 1(a) and 1(b), we can see that among the six families four families own one flat/ dwelling unit, one family owns two units and third unit is under construction. The no.-6 family is taking the multi-ownership housing system as his business which affects his monthly income level. Again from the chart, we can see that, no.-3 and no.-5 family are being able to save 54.54% and 53.76% of their income respectively which actually provoke them to think about the taking title of another unit or dwelling unit.

Now if we break down the expenditure of these families we can found-

Table 2(a): Break down of monthly expenditure (Matikata)

	Per capita household expenditure (tk)	Flat maintenance charge			Service charge (tk)	Loan repayment (tk)	Other cost (tk)	Another unit (tk)
		Gas bill (tk)	Electricity bill (tk)	Other (tk)				
1	24,950	650	1500	1000	2000	1200		
2	21,340	650	1000	1000	2000	600		
3	14,025	650	750	700	1800	600		
4	11,450	650	1000	2000	2000	5000	600	
5	16,620	650	1000	2000	2000	600		
6	20,050	650	1000	2000	2000	5000+600	30,000	

Table 2(b): Break down of monthly expenditure (Khilgaon)

	Per capita household expenditure (tk)	Flat maintenance charge			Service charge (tk)	Loan repayment (tk)	Other cost (tk)	Another unit (tk)
		Gas bill (tk)	Electricity bill (tk)	Other (tk)				
1	10,000	650	1200	1000	1000	6150		
2	10,000	650	500	500	500	7000	850	
3	25,000	650	2500	1000	3000	6000	11,850	
4	16,250	650	2000	2000	3000	7000	1,600	
5	13,300	650	2000	2000	1500	7150		
6	14,000	650	1000	2000	2000	8350		

Here, it should be noted that, with same monthly income two families with different family size will have to different expenditure in total. So, to avoid this problem, the per capita monthly expenditure has been counted here.

6.2. BUILDING CONSTRUCTION COST DETAIL:

Table 3(a): Building/ construction cost detail (Matikata)

	Total Construction Cost (tk)	Land Cost
1	5,478,000	410,850
2	5,084,000	508,400
3	5,594,000	447,520
4	5,254,000	472,860
5	5,844,000	584,400
6	5,444,000	381,080

Chart 1(a): Comparative Analysis of Construction and Land Cost (Matikata)

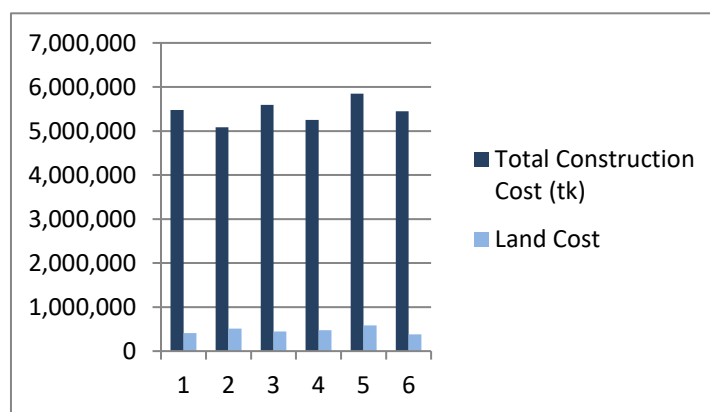
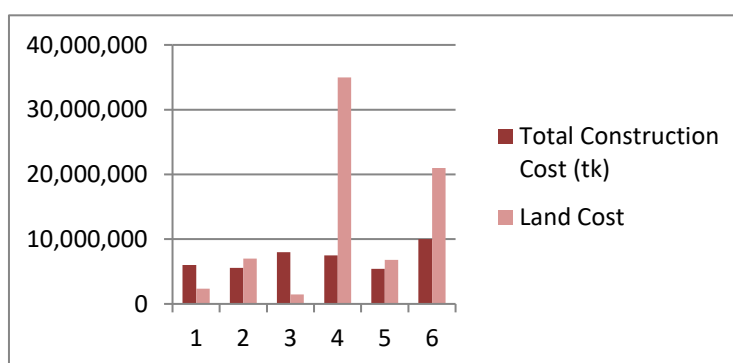

Table 3(b): Building/ construction cost detail (Khilgaon)

	Total Construction Cost (tk)	Land Cost
1	6,000,000	2,375,000
2	5,550,000	7,000,000
3	8,000,000	1,470,000
4	7,500,000	35,000,000
5	5,400,000	6,800,000
6	10,000,000	21,000,000

Chart 1(b): Comparative Analysis of Construction and Land Cost (Khilgaon)



6.3. HOUSING FINANCE AND ALTERNATIVE SOURCES OF FINANCE FOR MULTI-OWNERSHIP HOUSING:

Table 4(a): Finance and alternative sources of finance (Matikata)

	Amount of initial investment	Savings from salary & allowances	Business	Tuition	GPF loan	Short-term loan	Long-term loan
1	●	●	●				
2	●				●		
3	●						●
4	●			●		●	(500,000)
5	●					(1,000,000)	
6	●	●	●	●			

Table 4(b): Finance and alternative sources of finance (Khilgaon)

	Amount of initial investment	Savings from salary & allowances	Business	Tuition	GPF loan	Short-term loan	Long-term loan
1	●	●				●	
2	●						● (9% interest)
3	●						●
4	●						●
5	●						● (11% interest)
6	●	●					

If we see the table – 4 stated above we can see that, the no. -4 family have to take the long term bank loan of 5,00,000/- and have to repay at the amount of 5,000/- monthly. Again, the no.-5 family had to take a short term loan of 10,00,000/- from their relatives for the initial investment. The other sources have been clearly stated in the chart.

6.4. LAND VALUE AND FLAT SIZE:

Table 5: Flat size and cost

Matikata			
	Flat size (sft)	Unit prize per sft (tk)	Unit no. per floor
1	1400	4000	4
2	1200	4000	4
3	1400	4000	4
4	1500	3500	2
5	1500	4000	4
6	1400	4000	4
Khilgaon			
	Flat size (sft)	Unit prize per sft (tk)	Unit no. per floor
1	800	3,750	2
2	675	4075	2
3	1000	4000	2
4	1410	3200	2
5	640	4218	2
6	1300	7000	1

Table 6: Land size and cost

Matikata			
	Land (katha)	Actual value of land (tk/katha)	Registered value of land (tk/katha)
1	8	1,080,000	600,000
2	7	1,090,000	600,000
3	10	2,020,000	704,000
4	5	1,090,000	600,000
5	10	2,000,000	700,000
6	10	2,000,000	700,000
Khilgaon			
	Land (katha)	Actual value of land (tk/katha)	Registered value of land (tk/katha)
1	3.75	2,500,000	1,200,000
2	2	3,500,000	8,200,000
3	3.5	420,000	250,000
4	5	7,000,000	3,280,000
5	2	3,400,000	1,200,000
6	3.5	6,000,000	2,800,000

Chart 2(a): Actual and registered land value comparison (Matikata)

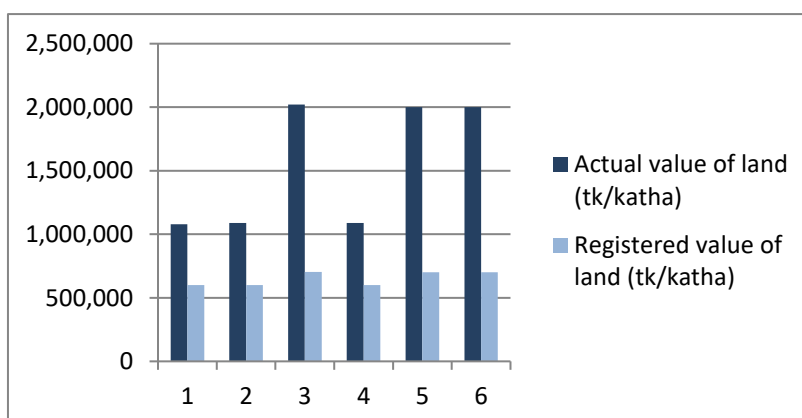
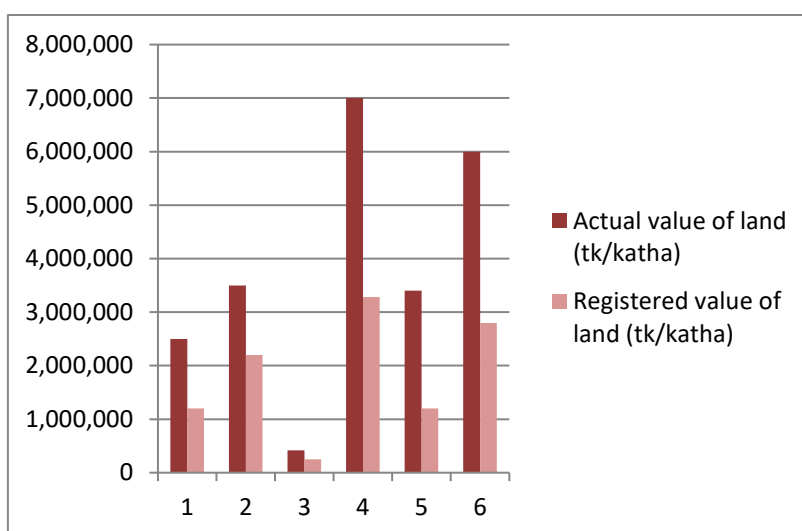

Chart 2(b): Actual and registered land value comparison (Khilgaon)



6.5. INCOME TAX & HOLDING TAX:

Table 7: Income tax, holding tax

Matikata			
	Total income Tk/month	Income tax (10% of monthly income) Tk/month	Holding tax (7% of annual valuation of the unit – 2 months valuation)/12 Tk/month
1	130,000	13,300	816.67
2	102,000	10,200	700
3	110,000	10,100	816.67
4	65,000	6500	875
5	93,000	9300	875
6	200,000	20,000	816.67
Khilgaon			
	Total income Tk/month	Income tax (10% of monthly income) Tk/month	Holding tax (7% of annual valuation of the unit – 2 months valuation)/12 Tk/month
1	70,000	7000	672
2	35,000	3500	285
3	110,000	10,100	1260
4	80,000	8000	592
5	50,000	5000	268
6	85,000	8,500	546

6.6. REASONS BEHIND CHOOSING THE LOCATION:

- Affordable price within budget, biased by relatives
- Affordable price within budget
- Ensuring quality and comparatively larger flat size within budget
- Near to work place and educational facilities, affordable price within budget
- Near to work place and educational facilities, affordable price within budget
- Business, building flat within affordable price and then sell it or rent it

6.7. TARGET GROUP AND INCOME TREND: AFFORDABILITY ANALYSIS:

Table 8: Target group and income trend: affordability analysis

Matikata				
	Grade no. according to pay scale	Rent allowance	Total savings	comment
1	Grade – 3	33,000	50,000	sufficient
2	Grade – 3	28,000	32,000	sufficient
3	Grade – 3	33,000	60,000	sufficient
4	Grade – 7	14,500	19,400	Not sufficient
5	Grade – 7, Grade – 8	14,500 +11,500	50,000	sufficient
6	Grade – 7	14,500	100,000	sufficient
Khilgaon				
	Grade no. according to pay scale	Rent allowance	Total savings	comment
1	Grade 7	14500	20,000	Sufficient
2	Grade 11	6000	5,000	Not sufficient
3	Grade 4	25000	10,000	Not sufficient
4	Grade 7	14500	15,000	Sufficient
5	Grade 9	11000	10,000	Sufficient
6	Grade 6	17750	15,000	Not sufficient

7. Synthesis

Analysing all the case studies it can be seen that,

- There are varieties of form of multi ownership housing in both the areas.
- There are a major difference between the actual land price and the registered land price.
- From the survey it is clear that, the people lived here are basically middle income group. From upper middle to lower middle income group of people have been found here.
- Variations in pay scale can be seen from Grade 4 to Grade 11.
- Comparing their income trend, it can be clearly understood that most of the cases the savings are not sufficient to afford a private housing properly maintaining all the basic and daily needs. But their savings are nearly sufficient for multi-ownership housing.
- Quick and small down payment delivery system of housing is popular here.
- There is shift of percentage of building or construction from land cost to finishing cost. It is because of the increase in price of land, building materials and finishing materials.
- Generally inhabitants are financing their housing from personal saving (Direct finance) and from loan from different financial institutions (Indirect finance)
- Here, people were needed the alternative sources to finance their housing, only savings were not sufficient.
- In the study areas, maximum people at first form a co-operative and then they buy a land together. At that time, one person can buy more than one share according to their investment capacity or affordability. So multi-ownership has become the only viable option for the middle income group to ensure a permanent shelter in the capital city.

8. Conclusion

Continuous population growth at Dhaka has made the problem of housing as one of the major challenge for coming years. Political instability, high rural-urban migration rate, increasing demand of housing, high interest of bank credit, increasing price of land and building materials- all these have made housing or dwelling units beyond the reach of majority of people.

Present change in income trend has a direct impact on the mode of ownership of housing. Now people are more interested in multi-ownership housing rather privately owned single house. According to 8th national pay scale as declared by the government of Bangladesh, basic salary has increased. The increased purchasing power due to expansion of economy and inflow of remittance can also be seen as opportunity. In this circumstances multi-ownership has become the only viable option for the middle income group to ensure a permanent shelter in the capital city. Proper initiatives by government could enhance the affordability of multi-ownership housing. Salaries or house rent allowance may be increased or there should be some other low interest financial support provisions for housing.

9. References

- <https://en.wikipedia.org>
<http://www.housing.nsw.gov.au/centre-for-affordable-housing/about-affordable-housing>
<https://www.nar.realtor/topics/housing-affordability-index>
 National Board of Revenue (NBR) Report,2014-2015
 City Corporation Ideal Tax Schedule, 2 March,2015, Bangladesh Gazette
 Page 18, Ward 24, Khilgaon A Block, House Rent Zone 2, Customs Department, Area 4,
 Dhaka South City Corporation.
 National Pay-Scale 2015
 Sanjoy Pal, Mohammad Sharif Hossain, 2014, Innovation of Housing Finance Systems and Implication in Bangladesh- A
 Categorical Study on Financial Markets, Cabc, Volume-1,issue-1
 S.M. labib, Md. Mushfikur Rahman Bhuiyan, Md. Zahidur Rahman, 2013, Location and Size preference for Apartment in
 Dhaka and Prospect of Real Estate market, Volume -9, issue-2,Page 87-96
 Md. Kamruzzaman, 2013, Apartment Housing in Dhaka City: Past, Present and Characteristic Outlook
 Israt Islam, Suman Kumar, Mitra, Md. Abu Nayeem, Mohammad Aminur Rahman, Land Price in Dhaka City: Distribution,
 characteristics and Trend of Changes
 CHOWDHURY Md Zaber Sadeque, 2013, The Housing Affordability Problems of the Middle-income Groups in Dhaka: A
 Policy Environment Analysis, Ph.D paper, University of Hong Kong, <http://hdl.handle.net/10722/193500>
 Affordable Housing for All, Chapter 6, 2016, Dhaka structural Plan 2016-2017.
 Bangladesh Household Income and expenditure Survey Report, 2010, Bureau of statistics(BIS), Government of Bangladesh.

- Bangladesh Gazette, March 2015
- Rosten Woo, John mangin, 2009, what is Affordable Housing, page 5-39
- Dr. Mostofa Kamal, Dr. Md. Omar Faruk Sarker, Shah Alam Kabir Pramanik³, 2016, Investigation of Market Factors That Affect Customers' Buying Attitude towards Apartment Buying: An Opportunity Analysis from Bangladesh Perspective, Vol. 7, No. 3, International Journal of Business Administration, <http://ijba.sciedupress.com>
- Muhammad Shamsuzzaman, 2014, A Comparative Analysis of Plot Housing Schemes and multi-Storeyed Apartment Block Housing Schemes in Dhaka: Land Economization and Urban Community Services in the Context of Post Private Housing Land Development Rule, 2004 Scenario of Bangladesh, Vol. 7, December 2014, pp. 1-10, Journal of Bangladesh Institute of Planners, ISSN 2075-9363.
- Lan Deng, Qingyun Shen, Lin Wang, 2011, The Emerging Housing Policy Framework in China, Vol 26, No-2, 168-183, Journal of Planning Literature.
- Mostafa Kamal, Md. Kamruzzaman, 2015, Vol. 9, No. 1, PP. 27-41, Daffodil International University, Journal of Business and Economy

Samarawickrama, Sumanthri, et al (eds), 2018, "Sustainability for people - envisaging multi disciplinary solution": *Proceedings of the 11th International Conference of Faculty of Architecture Research Unit (FARU), University of Moratuwa, Sri Lanka, December 08, 2018* Galle pp. 165–173. ©

INFLUENCE OF TREE SHADE LEVEL ON COMFORT PERCEPTION - A CASE STUDY OF OUTDOOR PUBLIC SPACES OF VIHARAMAHADEVI PARK, COLOMBO

CALDERA. A¹ & PERERA. N. G. R²

Department of Architecture, University of Moratuwa, Sri Lanka

¹aic1993@hotmail.com, ²nareinperera@gmail.com

Abstract

Trees play a vital role in the Sri Lankan context in providing thermal comfort in many outdoor spaces including public parks. But most trees have not been effectively chosen and positioned for public comfort. The research focuses on the impact of sky visibility, through tree canopies, on the perception of comfort for people in outdoor urban public spaces. Viewing the sky has psychological and physical benefits as well as aesthetic appeal. The aim of the research is to find optimum levels of tree shade and sky view that should be provided by trees for human comfort. The study was conducted in Viharamahadevi Park, Colombo. The plant area index (PAI) was used to categorize the tree shade level and was calculated using the software CAN-EYE, based on 'fish-eye' lens photographs, together with a perception survey of users. It was found that satisfactory sky view was proportional to the perceived comfort. In the morning, people were comfortable in moderate to high shade (PAI 0.72 to 4.48), but in the evening people were comfortable in slight to moderate shade (PAI -0.93 to 1.07). The discussion will show that a certain level of sky view does not reduce thermal comfort perception and is necessary for better outdoor comfort.

Keywords: *Comfort Perception, Sky View, Tree Shade, Plant Area Index, Public Outdoor Space.*

1. Background

The demands of the growing population has resulted in urban areas expanding and building densities increasing. This has altered the surface energy and moisture balance of urban areas and led to environmental issues such as the urban heat island (UHI) effect, human thermal discomfort, air quality degradation, and microclimate modification (Zhao et al., 2018). The quality of outdoor spaces in urban areas plays a fundamental role in quality of life within cities (Makaremi et al., 2012). In order to sustain life outdoors it is important that we try to make urban spaces comfortable as far as the ambient climate permits. One such way is providing thermal comfort. Outdoor thermal comfort is a complex function of atmospheric conditions and physical, physiological, psychological, and behavioural factors. But thermal comfort is not the only comfort factor necessary for creating comfortable outdoor spaces, visual comfort is also deemed important.

Landscape must be able to affect the human's visual comfort in a positive way and a highly aesthetic landscape would affect human psychology and behaviour as well (Othman, Mohamed, & Ariffin, 2015). The vegetation density, shade patterns, shadows, view and colour of the sky, sky line and surrounding views impact the visual and aesthetic comfort in an urban setting. Vegetated spaces in urban areas are essential to improve people's living environment ecologically and aesthetically (Song & Wang, 2015). Trees are one of the most important components of urban green infrastructure and is becoming an integral feature of urban designs (Tzoulas et al., 2007). Trees provide multiple microclimate benefits by reducing solar radiation penetration, reducing net energy absorption by canopy shading, blocking the exchange of long-wave (infrared) radiation inside urban canyons and generating evapotranspiration (Wang et al., 2016). The importance of shade to reduce thermal stress in hot climates has been emphasized by several authors (Johansson & Emmanuel, 2006; Vanos et al., 2010). It is very important to understand how spatial environments affect thermal perception. Naturalness and aesthetic appreciation of the environment are some psychological aspects that influence perceived thermal comfort (Nikolopoulou & Steemers, 2003). It is a positive factor that in Sri Lanka shade trees are extensively used in outdoor spaces to provide shade instead of using artificial (built) means. But in choosing trees for urban outdoor spaces, special attention has not been given to comfort that different trees provide with their characteristics and thus, trees are not utilised effectively.

In addition to vegetation, the sky is also an important factor of the environment for outdoor experience. The sky is an element of nature that has been admired by many for its beauty. In addition to its aesthetic qualities, viewing the sky both intentionally and unintentionally has psychological impacts on people. In the “Experience of Landscape” (Appleton, 1975), the sense of prospect is signalled by distant brightness and refuge is signalled by shadow. High prospect environments include open views to the horizon and a luminous sky (‘big sky’). A sense of refuge is provided by shadows from tree canopies, cliff overhangs, or other natural forms. The shade solutions provided for thermal comfort in outdoor spaces can block sky visibility during the limited amount of time the urban population spend outdoors. Most of these solutions provided in the daytime is not needed at night and they unnecessarily block the night sky view. An important finding by Swardon (1988) was that the relationship between preference and amount of trees and other vegetation may be non-monotonic, that is, vegetation up to a point which then might flatten out or possibly decline (Swardon, 1988). Therefore, understanding the shade conditions that provide comfort to the person using it, in terms of canopy gaps and the perception of thermal comfort of the users becomes important. A balance between shade and view of the sky needs to be established when designing for urban outdoor environments. Adequate research has not been done on the amount of sky visible that will create the highest outdoor comfort (both thermal and psychological). So the need arises to find the adequate amount of shade for human comfort that provides both thermal comfort and sky visibility. This is deemed to be a worthy study area as it is necessary for the wellbeing of the urban public, increasing the usability of public spaces.

The primary objective of the study is to examine the impact of different tree shade levels - therefore sky visibility - according to their Plant Area Index, on perceived human comfort and analyse which tree shade patterns provide better comfort to the user - both physiologically and psychologically.

1.1. LEAF AREA INDEX (LAI) AND PLANT AREA INDEX (PAI) FOR QUANTIFYING TREE SHADE LEVEL

One well established index that describes the plant cover is the Leaf Area Index (Song et al., 2018). It is defined as projected leaf area per unit ground area (Gower & Norman, 1991 as cited in Song et al., 2018). The LAI and canopy density reflect the differences in the plant spatial structure. The results of many studies have shown that with an increase in LAI, the cooling effects of green space increases (Xiao et al., 2018). In contrast, Kong showed that the cooling effect of green LAI and sky visibility was different at different periods of time, with a peak from 9:00-19:00 and a decline from 13:00-15:00 due to the impact of high temperatures around noon (Xiao et al., 2018). However, instead of LAI this study uses Plant Area Index (PAI) which is an estimate of the fraction of ground shaded by the vertical projection of tree crowns (Pekin & Macfarlane, 2009). PAI may be more appropriate from which to compare the shade of individual trees, as LAI only focuses on the leaves (Breda, 2003), whereas PAI accounts for all the physical elements of the canopy such as branches, twigs, fruits, flowers and leaves (de Abreu- Harbich, Labaki, & Matzarakis, 2015; Macfarlane et al., 2007).

LAI can be estimated directly or indirectly. Direct methods measure LAI through litter fall or destructive sampling. Indirect methods estimate LAI via relationships with other more easily measurable parameters. But indirect measurements actually only allow assessing PAI, because it is not possible to know if some leaves are present behind the stems, branches or trunk. Therefore, masking some parts of the plants to keep only the visible leaves is not correct and could lead to large under-estimation of the actual LAI value, depending on the way leaves are grouped with the other parts of the plant. (Hardwick et al., 2015) Therefore, PAI instead of LAI is used. PAI indirect measurement techniques are based on contact frequency or gap fraction measurements. Contact frequency is the probability that a beam (or a probe) penetrating inside the canopy will come into contact with a vegetative element. Conversely, gap frequency is the probability that this beam will have no contact with the vegetation elements until it reaches a reference level (generally the ground). The term “gap fraction” is also often used and refers to the integrated value of the gap frequency over a given domain and thus, to the quantity that can be measured (Kaufmann et al., 2010), especially using hemispherical images.

2. Method

The study was conducted in a selected area of Viharamahadevi Park, Colombo 07. It is located in Colombo and is popular among the residents of Colombo as an outdoor recreation space because of its location with easy access to public transport, businesses, offices, shops and residences. The park has a large variety of trees. (see Figure 1.)

The behaviour of the people in the study area was recorded and a sample of 120 people were selected for the perception study. Of these 120 people; 5 person sample was chosen, where the users exceeded

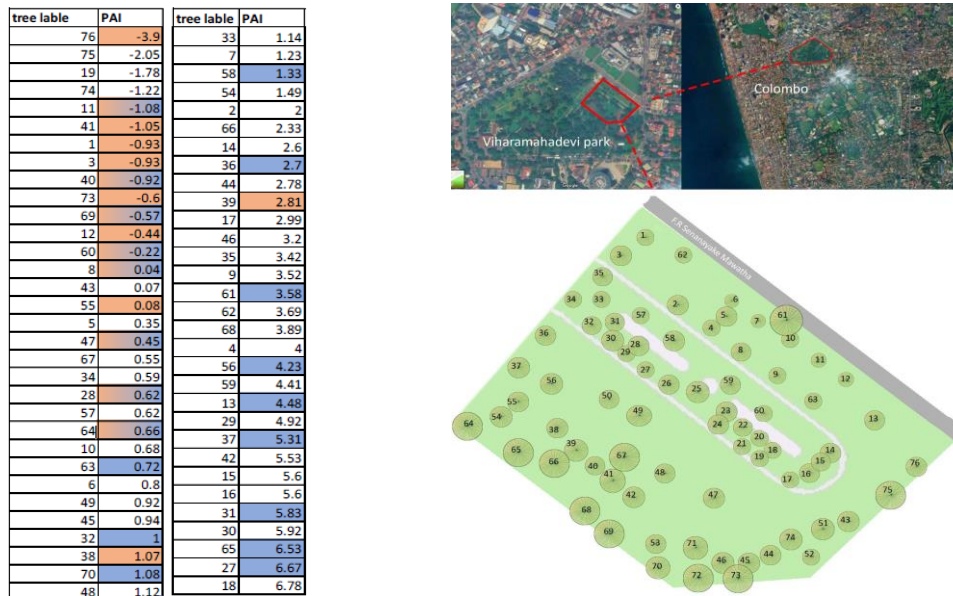

Figure 22. PAI of the trees in the plot with tree label. Orange colour bands for the trees chosen in the morning. Blue colour bands for the trees chosen in the evening

5 under a particular tree, during the two hour study period each in the morning and evening. Fourteen trees had more than five people enjoying its shade, thus surveyed. These included at least 10 people each of; Thin Canopy (PAI less than 1), Dense Canopy (PAI more than 1) and 10 people in Open Spaces with no tree shade were also chosen, in random, as a sample group.

Digital Hemispherical Photographs (DHP) were obtained close to sun rise under uniform sky conditions because the DHPs have to be taken under diffused light conditions. The acquisition parameters followed Macfarlane et.al. (2007). the digital camera was equipped with a (Nikkor 10.5mm fisheye lens). The lens was aligned to magnetic north and pointed upward using a levelled tripod. Upward DHP of each tree canopy in the study area was taken from 6.10am – 6.40am fulfilling the need to be taken under diffused light conditions. The photographs were analysed using the CAN-EYE V6.4.91 software to calculate the PAI of each tree in the study area and the percentage of sky and leaf cover. Subjective behaviour and response data was collected on four weekends; two Saturdays and two Sundays from 9am-11am and 4pm- 6pm on the basis that the selected study area in most active around those times and the sunlight condition was ideal.

Subjective response data were collected through the distribution of questionnaires and conducting interviews on the four weekends, in June 2018. The questionnaire was prepared with the use of Bedford scale 7 point scale of thermal comfort, the McIntyre 3-point scale and the Likert 5 point scale on general comfort. It was distributed to people who were staying in the shade of trees and open spaces in the study area.

The questionnaire collected the following data;

- The place of residence of each person
- Whether they spend most of their time indoors or outdoors.
- The period of time they have been staying in the place
- The reason for choosing the place they were staying at
- Whether they have changed space they were staying at, and if so, the reason for changing relaxing location.

- Their perception of the visible sky
- Their perceived thermal comfort
- Their perceived comfort (psychological and physical)
- Their preference for the amount of sunlight, the brightness of the sun, the illuminance of the space, feeling sleepy, wanting to stay for more than an hour, wanting the sky to be more visible and the feeling of personal safety.

3. Results and Discussion

The range of the PAI of the trees in the study area is from -3.9 to 6.78 (see Figure 1), -3.9 being the tree with the most sky visible through the canopy and 6.78 being the tree with a denser canopy and the least sky visible through the canopy. For the purpose of this study, PAIs were categorised into five shade levels according to the amount of sunlight coming through the canopy; 1) -3.90 to -1.76 : very slight shade, 2) -1.76 to 0.39 : slight shade, 3) 0.37 to 2.50 : moderate shade, 4) 2.50 to 4.64 : high shade, 5) 4.64 to 6.78 : very high shade.

3.1. SHADE PREFERENCE DATA ANALYSIS DURING MORNING HOURS

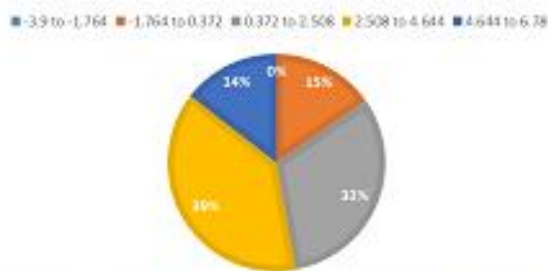

Figure 2. Number of people under tree shade according to tree PAI value intervals -

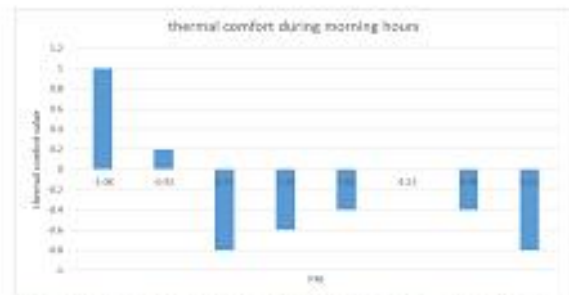

Figure 3. Thermal comfort to PAI relationship - Morning

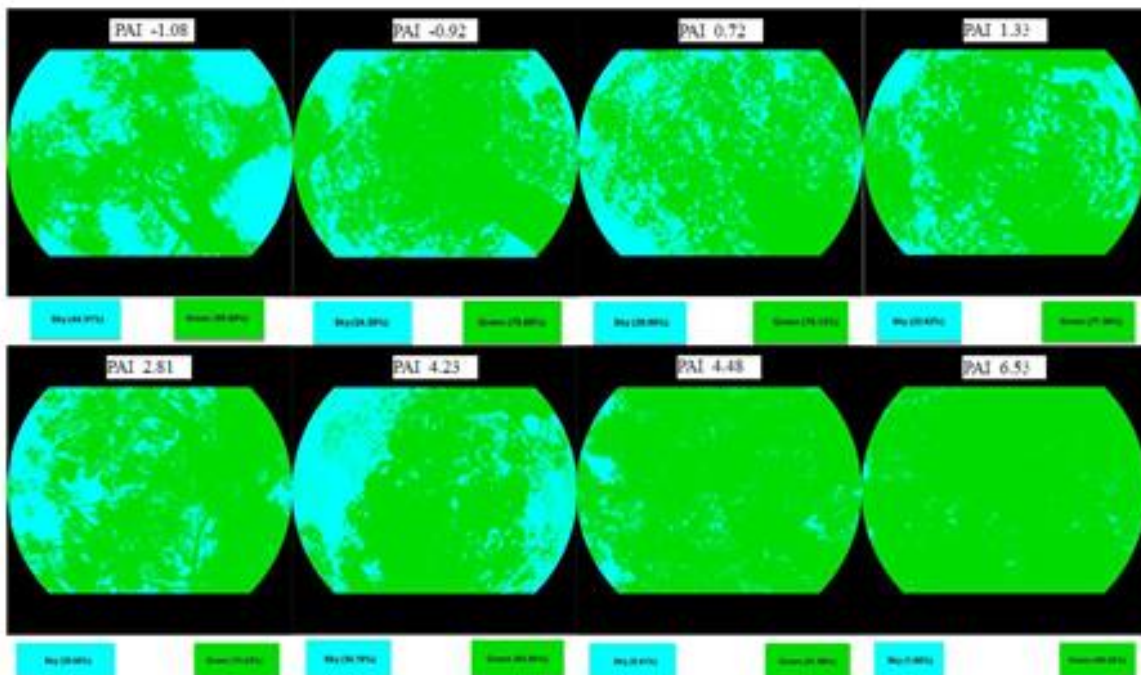

Figure 4. Percentage of sky and green of each tree canopy selected to stay under during the morning. Percentage calculated by CAN-EYE V6.4.91

The average temperature during the morning study period 9am – 11am was 30°C. The trees chosen by the users during the morning hours had a wide range of PAIs. It is seen that there is a tendency for

people choosing trees with a denser canopy and less view of the sky during morning hours. (see Figure 2.), although a clear pattern is not evident. An example of this is - during the morning time where the brightness of the sun is high, 15% of the people chose trees with low PAIs. The perceived thermal comfort under the trees in relation to PAI shows a clear pattern where beyond a certain PAI threshold the thermal comfort increases with increasing PAI. (see Figure 3.)

In analysing the data on overall comfort - physiological and psychological - the results paint a different picture. The results show a depreciating comfort value for very high PAIs and very low PAIs. Thus, demonstrates an ideal value, where a quantum of sky view is desired by the user. (see Figure 5 / 6.)

Figure 7 shows that the primary reason people relocate from one shade tree to another is the level of shade it provides. (see Figure 7.)

The trees that gave the most comfortable shade were not the trees that gave the most thermal comfort underneath. The reason for this can be analysed according to the preference votes for the factors that affect comfort. (see Figure 3/4/5)

Comparative analysis of PAI based, survey categories in the morning hours (see Figure 8.) show the sense of safety increases with increasing PAI and with it the desire to stay more than an hour in the setting. The desire for sky view transitions from 'disagree' to 'agree' with the canopy becoming denser with increased PAI, thus signifying the importance of shade to sky view balance. The results also show that beyond a PAI of 2.81, people perceived that it was getting too dark, confirming the statement above.

3.2 SHADE PREFERENCE DATA ANALYSIS DURING EVENING HOURS

The average temperature during the evening study period 4 pm – 6 pm was 31°C. The trees chosen by the users during the evening hours had a short range of PAIs. It is seen that there is a high tendency for people to choose trees with less denser canopies and more view of the sky during evening hours. The highest percentage, 58%, of people were under trees with PAI range from 0.372 to 1.764. The second highest, 29%, were from trees with PAI range from 0.372 to 2.508. These PAI values allow a significant amount of sunlight through the canopy. The highest percentage of people were not under the trees with the highest PAI, as only 8% were under trees with PAI range from 2.508 to 6.78. In the evening, the highest percentage of people preferred to stay under trees with slight shade. The second highest percentage of people preferred to stay under trees with moderate shade. A very small percentage of people were staying under trees with very slight shade and high shade. No people were found staying under trees with very high shade.

Figure 10 compares the perceived thermal comfort of people (5 or more people) under shade trees, in the evening hours, as against the PAI values. A perceived Thermal Comfort Value of zero is defined as comfortable. Unlike in the morning hours, the thermal perception of people surveyed, does not show a clear pattern in relation to the PAI of the trees in question. The values differ by only slight margins, and close to the comfort threshold of '0'. Therefore, it can be deduced that most people were comfortable under trees in the evening. Trees with a PAI of 2.81 was seen as the most comfortable.

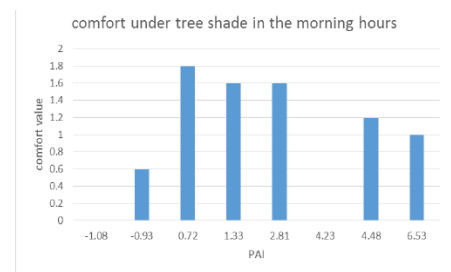

Figure 23. Comfort under the selected trees according to their PAI in the morning

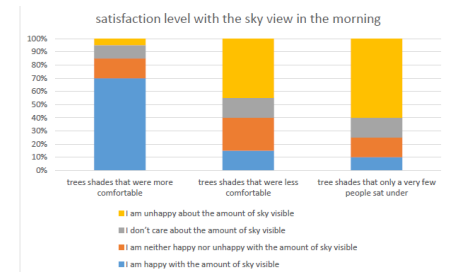

Figure 6. Satisfaction level in relation to the sky view - Morning

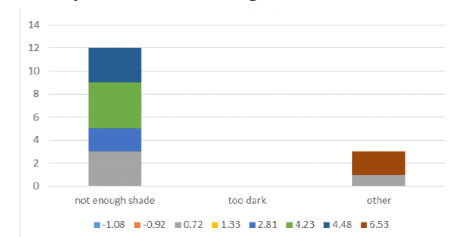

Figure 7. Reason for changing location, in the morning



Figure 8 Preference votes of trees with PAI

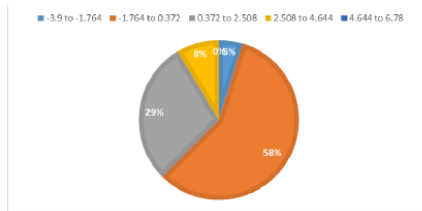

Figure 9. Number of people under tree shade according to tree PAI value intervals - Evening

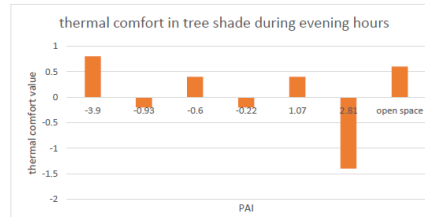

Figure 10. Thermal comfort to PAI relationship - Evening

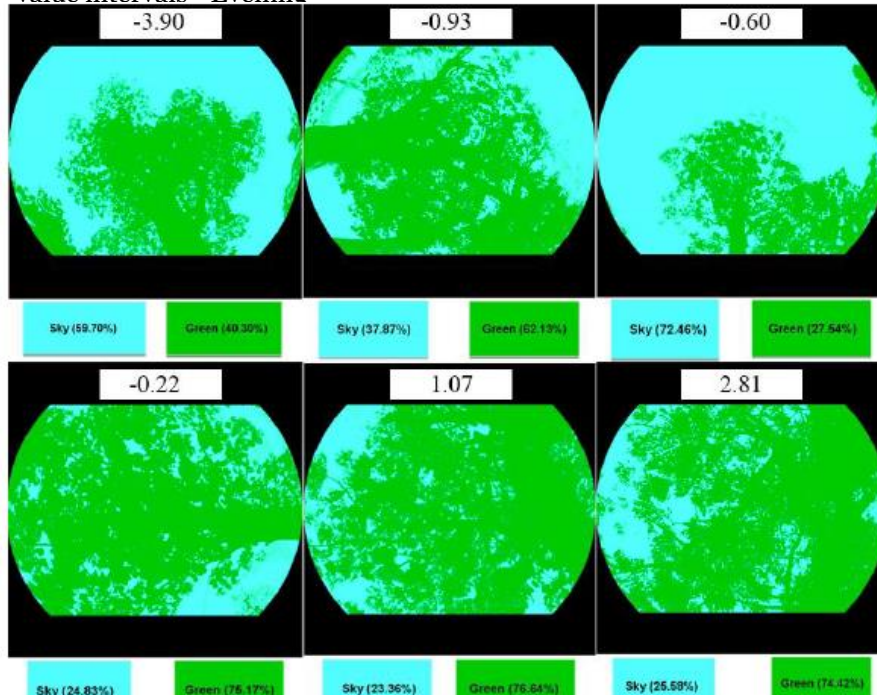

Figure 11. Percentage of sky and green of each tree canopy selected to stay under during the evening. Percentage calculated by CAN-EYE V6.4.91

The percentage of sky for these tree canopies calculated using upward DHP by the CAN-EYE image analysing software are 37.87%, 72.46%, 24.83% and 23.36% respectively. Trees that most of the people were thermally comfortable when underneath during the evening were the trees that have a view of the sky through the canopy from 23.36% to 72.45%, thus a wide range.

As opposed to the lack of a trend in thermal comfort perception, the results for the overall perception of comfort shows a similar trend to that of the morning hours, albeit a narrower range. It is clear that the perception in the evening hours signal an increased desire for views of the sky, together with shade provision. The comfort perception for shade is signified by the lower comfort level in open spaces, as identified by the survey data. (see Figure 12.).

Figure 13 demonstrates the relationship between comfort perception and sky view as a positive element in the space observed. Therefore, the balance between shade and sky view is again signified.

Unlike in the morning hours the primary reason people relocate from one shade tree to another, are reasons beyond the shade level of trees, thus deemed less important. (see Figure 14.)

Comparative analysis of the PAIs of trees in the evening hours (see Figure 15.) shows that all users felt safe and would like to stay for more than an hour. Thus, the correlation between shade level, PAI and perception is not as clear as in the morning. Similarly, the Sun's ingress into the space under the tree canopy was welcomed.

A significant difference is seen in the level of relaxation - signified by the feeling of sleep in the survey - is greatly diminished as opposed to the morning hours.

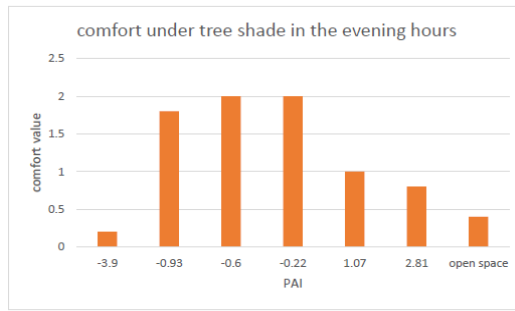

Figure 12. Comfort under the selected trees according to their PAI in the evening

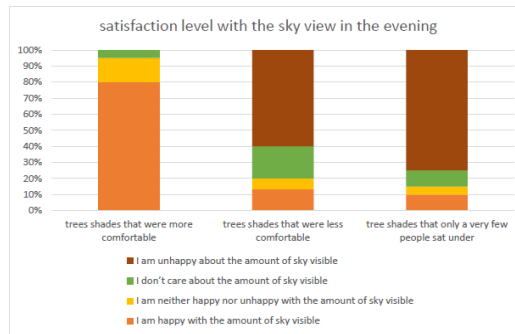

Figure 13. Satisfaction level in relation to the sky view - Evening

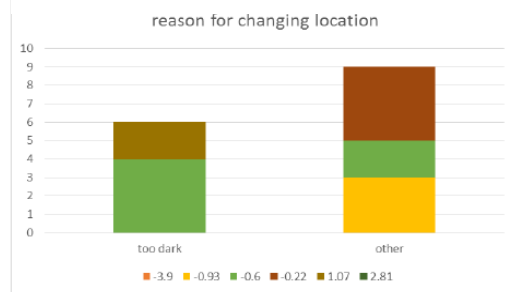

Figure 14. Reason for changing location, in the evening



Figure 15. Preference votes of trees with PAI -0.93, -0.6, -0.22 and 1.07 whose shade where chosen as comfortable - Evening

5. Findings and Implications for Landscape Design

The perceived thermal comfort and overall comfort of people in urban parks in Colombo varied according to the tree shade and sky view, particularly in the different time periods of the day considered. The people were found

to be well aware of the sky and its contribution to comfort, therefore any design decision needs to consider the quality of the shade provided.

Satisfactory sky view percentage for people using urban parks in Colombo was different in the morning from the evening. In the morning the more satisfactory sky view percentage was 8% to 29%. In the evening it was 23% to 38%. This is deemed to relate to the solar radiation penetrating the tree canopy, with a reduction in the evening, the people are more tolerant and thus conducive for increased views of the sky. The difference in the range of PAIs the people prefer is another indication of this phenomena. Thus, In the morning people chose to sit under the shade of trees having PAIs that spread over a wider range of values, from -1.08 to 6.67 (although the density of people was high only for trees having PAIs in the range 0.3 to 4.7). in the evening people chose to sit under the shades of trees having PAIs that spread over a shorter range of values, from -3.90 to 2.8. Zoning of vegetation in the landscape is key to generate heterogeneity and interest in a particular urban park.

6. Conclusion

This research was conducted to identify the impact that the amount of shade and sky visible through shade tree canopies has on people's perception of comfort and hence identify the level of tree shade that provides the maximum comfort. With the Viharamahadevi Park as a case study we mapped the PAI of trees in a selected area and then surveyed users in this context. The study was limited to a typical day in June and over four weekends.

The two time zones and their differences generated in the perception of users is significant. It highlights the need for landscape design to consider not only thermal comfort of the setting but also the overall comfort, essentially encompassing visual comfort - expressed by the view of the sky through the tree canopy. The selection and application of tree places in an urban park needs to be executed carefully. A designer might opt for a certain level of heterogeneity, thus every tree need not be meant for people to sit under. Thus this study can be expanded to encompass such a mapping protocol, including specific tree species mapping. As explored in the study the PAI can be a useful approach for designers to make informed decisions for the overall well-being of the people in an urban park.

7. References

- Appleton, J., (1996). *The Experience of Landscape*, Wiley, ISBN047196235X
- Hardwick S, Toumi R, Pfeifer M, Turner EC, Nilus R, Ewers RM. The relationship between leaf area index and forest microclimate in tropical forest and oil palm plantation: Forest disturbance drives changes in microclimate. *Agricultural and Forest Meteorology* 2015, 201, 187-195.
- Breda, N. J. J. (2003). Ground-based measurements of leaf area index: a review of methods, instruments and current controversies. *Journal of Experimental Botany*, 54(392), 2403–2417. <https://doi.org/10.1093/jxb/erg263>
- De Abreu-Harbich, L. V., Labaki, L. C., & Matzarakis, A. (2015). Effect of tree planting design and tree species on human thermal comfort in the tropics. *Landscape and Urban Planning*, 138, 99–109. <https://doi.org/10.1016/j.landurbplan.2015.02.008>
- Johansson, E., & Emmanuel, R. (2006). The influence of urban design on outdoor thermal comfort in the hot, humid city of Colombo, Sri Lanka. *International Journal of Biometeorology*, 51(2), 119–133. <https://doi.org/10.1007/s00484-006-0047-6>
- Kaufmann, H. et al. (2010): Hyperspectral algorithms: report of the frame of EnMAP preparation activities. Potsdam: Deutsches GeoForschungsZentrum GFZ, 268 S. Scientific Technical Report STR 10/08. - DOI: 10.2312/GFZ.b103-10089
- Makaremi, N., Salleh, E., Jaafar, M. Z., & GhaffarianHoseini, A. (2012). Thermal comfort conditions of shaded outdoor spaces in hot and humid climate of Malaysia. *Building and Environment*, 48(1), 7-14. DOI: 10.1016/j.buildenv.2011.07.024
- Nikolopoulou, M., & Steemers, K. (2003). Thermal comfort and psychological adaptation as a guide for designing urban spaces. *Energy and Buildings*, 7.
- Othman, N, Mohamed, N, Ariffin, M H., *Landscape Aesthetic Values and Visiting Performance in Natural Outdoor Environment*, *Procedia - Social and Behavioural Sciences*, vol 202, 330-339, 2015, <https://doi.org/10.1016/j.sbspro.2015.08.237>
- Pekin, B., & Macfarlane, C. (2009). Measurement of Crown Cover and Leaf Area Index Using Digital Cover Photography and Its Application to Remote Sensing. *Remote Sensing*, 1(4), 1298–1320. <https://doi.org/10.3390/rs1041298>
- Smardon, R. C. (1988). Perception and aesthetics of the urban environment: Review of the role of vegetation. *Landscape and Urban Planning*, 15(1–2), 85–106.
- Song, J, Wang, Z., Impacts of mesic and xeric urban vegetation on outdoor thermal comfort and microclimate in Phoenix, *Building and Environment*, Vol 94, Part 2, 2015, 558-568, ISSN 0360-1323, <https://doi.org/10.1016/j.buildenv.2015.10.016>.
- Tzoulas, K., Korpela, K., Venn, S., Yli-Pelkonen, V., Kaźmierczak, A., Niemela, J., & James, P. (2007). Promoting ecosystem and human health in urban areas using Green Infrastructure: A literature review. *Landscape and Urban Planning*, 81(3), 167–178.

- Vanos, J. K., Warland, J. S., Gillespie, T. J., & Kenny, N. A. (2010). Review of the physiology of human thermal comfort while exercising in urban landscapes and implications for bioclimatic design. *International Journal of Biometeorology*, 54(4), 319–334.
- Xiao, X. D., Dong, L., Yan, H., Yang, N., & Xiong, Y. (2018). The influence of the spatial characteristics of urban green space on the urban heat island effect in Suzhou Industrial Park. *Sustainable Cities and Society*, 40, 428–439.
- Zhao Q, Yang J, Wang Z-H, Wentz EA. Assessing the Cooling Benefits of Tree Shade by an Outdoor Urban Physical Scale Model at Tempe, AZ. *Urban Science*. 2018; 2(1):4.

Samarawickrama, Sumanthri, et al (eds), 2018, "Sustainability for people - envisaging multi disciplinary solution": *Proceedings of the 11th International Conference of Faculty of Architecture Research Unit (FARU), University of Moratuwa, Sri Lanka, December 08, 2018* Galle pp. 174–181. ©

COST EFFECTIVENESS OF SUSTAINABLE ELECTRICITY CONSUMPTION IN DOMESTIC BUILDINGS.

THILINA LAKSIRI DISSANAYAKE¹ & ANUJI ARUNODA WAHALATHANTHRI²

Colombo School of Construction Technology (CSCT CAMPUS), Sri Lanka

¹thilina.dissanayake@csct.edu.lk, ²anujiarunoda@gmail.com

Abstract

Saving electricity has become a challenge in Sri Lanka due to the warmer climates prevailing throughout the years and it has become a major requirement to have fans and air conditioners occupied in most of the houses. That may effect to electrical consumption and the monthly electricity bill. However, in order to reduce electrical consumption in domestic buildings there are some methods which can be adopted in practice. This study has covered areas of cost effectiveness of solar electrical installation systems and importance of sub-metering houses along with benefits of using light-emitting diode (LED) bulbs instead of using compact fluorescent lamp (CFL) and incandescent (filament) bulbs. Data collection carried out through interviews and questioner surveys with customers and suppliers of solar electrical installations. After analysing the data gathered, even with a highly initial cost, solar electricity installations can be considered as a cost-effective method. Furthermore, specifications and details gathered on CFL, LED and filament bulbs proved LED bulbs are more cost effective than other bulbs for the same illumination level. This study also revealed that sub metering a house under the rules and regulations of Electricity Board is another cost-effective method where a house owner can adopt in their houses.

Keywords: *Energy efficiency, Electrical consumption, sustainability, Sub-metering, Solar power*

1. Introduction

Energy efficiency is considered as an important factor ensuring a safe, reliable, affordable and sustainable energy system for the future (International Energy Agency, 2018). Energy can be conserved in many ways and at many different levels of energy consumption. One of the major facts of conserving energy can be described as saving the electricity consumption. In several developing countries usually it can be identified a little margin between existing power supply and electricity demand. Along with the increasing electricity demand, new generation must be brought through renewable sources of electricity such as hydro, geothermal or wind provides electricity at a lower price (Matek & Gawell ,2008).

2. Literature Review

2.1. ELECTRICITY CONSUMPTION

The International Energy Agency (2018) statistics estimated that globally, building sector is responsible for 42 per cent of more electricity consumption than any other sector. This percentage depends greatly on the degree of electrification, the level of urbanization, the amount of building area per capita, the prevailing climate, as and as well as the national and local policies to promote efficiency.

In this situation, the Central Intelligence Agency (2018) has ranked Sri Lanka as the eighty sixth country among 218 of countries for high electricity consumption (11.72 billion kWh). Ministry of Power and Renewable Energy Sri Lanka (2017) had pointed out that Sri Lanka's national electrification ratio has grown from 99.3% in 2016 to 99.7% in October 2017 and has already reached 100% electricity accessibility which is commendable by South Asian standards. Sri Lanka is the only country in South Asia that has 100% electricity accessibility with 24 hrs uninterrupted electricity supply. They have also emphasized that it is of national importance to move into renewable energies such as solar power and their target is to generate 1000MW from 1,000,000 solar tops around the country under the "Soorya bala sangramaya programme".

2.2 LIGHTING SYSTEM

According to the recent study of Wood and Matulka (2013) concluded that, lighting accounts for five percent of a home's energy use, which translates to about 11% of the home's electricity bill. Much of this is the result of using inefficient lighting methods adopted in the households (Terry et.al, 2013).

2.1.1 Comparing LED vs CFL vs Incandescent Light Bulbs

As the technology has advanced and environmental awareness has increased, energy efficiency has become of a paramount concern. It is common knowledge that choosing the right light bulb could drastically reduce customer's power bills and positively affect the environment. House owners has the options of choosing between incandescent, compact fluorescent (CFL), and light-emitting diode (LED) light bulbs to be used. However each one of the methods will have a different effect on the overall energy efficiency of the building.

According to the Sullivan (2015), there are two key terms pertaining to light bulbs; they are watts and lumens. With incandescent bulbs, the number of watts has become synonymous with the level of brightness, even though a watt really does not tell anything more than the amount of power necessary to light the bulb. Lumens, on the other hand, indicate the actual amount of light emitted by the bulb. For example, a typical incandescent 40W light bulb draws 40 watts of power and provides about 400 lumens of brightness. A CFL requires 9-13 watts and an LED light bulb uses 6-7 watts to provide the same amount of lumens.

Furthermore, CFLs have been touted enthusiastically in the past decade, However LEDs are beginning to surpass CFLs because they require as little as half the power and last 10 times longer than a CFL. Apart from the brightness and efficiency of the method cost is a good factor of comparing incandescent, compact fluorescent (CFL), and light-emitting diode (LED) light bulbs due to the fact that house owners are desperate in terms of the cost of application.

An Indian research had suggested that the estimated payback period of replacing an incandescent lamp with CFL is 1.2 years, and that of replacing a kerosene lamp with CFL is less than a year (Bhattacharya and Cropper, 2010). Compared to CFLs, LED lamps require a higher initial investment, but their long lifespan (up to 10 times of CFL) makes up for the high investment cost. As a rule of thumb, the investment cost for LED light is usually paid off within the first year of use. Maintenance costs are negligible during the lifespan of energy efficient lamps and ballasts.

Apart from the Technical details the easiest way of comparing the advantage of the different methods of lighting can be summarized as following table 1.

Table 1-Summary of Incandescent, CFL and LED Bulbs

	Incandescent		LED
		CFL	
Life span	1200 hrs	8000 hrs	25,000hrs
Watts used	60W	14W	7W
Average cost per bulb	Rs.150	Rs.300	Rs.600 or less
Total purchase price of bulbs over 20 years	Rs. 3150	Rs. 900	Rs. 600
Bulbs needed for 25,000 hours	21	3	1

Cost of electricity (25,000 hours at 22.50 per kWh)	Rs.25,375	Rs.7800	Rs. 4500
Total estimated cost over 20 years	Rs.31,650	Rs.8100	Rs.5100

After considering all the facts, though the initial cost of buying LED's is higher than other bulbs, they are becoming very affordable. Since LED bulbs are so much more efficient, and contain no toxic materials, it won't be long until these bulbs replace other bulbs as the standard means of lighting homes and businesses alike. Since life span of LED bulbs are high initial cost of buying LED bulbs can be recover in a short period further considering using for LED bulbs for houses is good for environment as well when comparing incandescent and CFL bulbs.

2.3 AFFORDABILITY OF SOLAR POWER SYSTEMS

The concept of solar energy is well suited to Sri Lanka as a good harvest on solar electricity and has been recorded in many places in the island. Increased solar energy generation and usage have been reported from the areas of Anuradhapura, Jaffna, Vavuniya, Kurunegala, Trincomalee, Mannar, Galle, Matara, Hambantota, Colombo, Batticaloa and Ampara where electricity demands are high, and consumers are cost conscious in their daily routines (Daily news,2018).

2.4 IMPORTANCE OF SUB-METERING BUILDINGS

If a multi-residential building has one central or bulk meter, along with landlords, property managers, condominium corporations or building owners. They will be responsible for the building's entire utility consumption. This can result in unfair allocation of energy costs to owner. Implementing sub-metering allows measurement of individual unit consumption and allows to be billed for each own consumption. Utility costs are one of the highest expenditures for a building. By sub-metering, building owners and operators are able to better control operational costs, allowing them to focus on other priorities. Resulting savings for the building can then be diverted to the building reserve fund or to other areas that need attention. (Enercare, 2018).

3. Research methodology

In order to investigate the research problem of this study, data collection was conducted in several areas such as Colombo, Matara, Kelaniya, Ambalangoda and also carried out a survey which was conducted in three main different areas. First area was solar power system suppliers. Five solar power systems suppliers were surveyed and collected data from their shops. Second area was people who installed solar power system in their houses. Therefore, seven houses who installed solar systems were surveyed. Third area was sub-metered and not sub-metred houses. Three sub-metered houses and two not sub- metered houses were surveyed to compare the cost effectiveness of sub-metering houses. Furthermore, research articles, websites, E-books and newspaper articles were referred as well.

4. Data Analysis

4.1 DEMAND FOR SOLAR ENERGY SYSTEMS

In present times, people are more interested in solar power energy more than past years. Interviews were conducted among solar suppliers in Colombo area .in order to identify the current demand for the solar energy in Sri Lanka.

Table 2-Details of solar system suppliers

Total number of installations so far	Solar shop 01	Solar shop 02	Solar shop 03	Solar shop 04	Solar shop 05
Domestic	1500	2500	13	175	190
Government office	100	20	00	01	15
Private office	200	20	00	18	30
Hotels	250	05	00	00	05
Other	550	10	00	20	00

This table shows information about total number of solar panels installations in different solar panels suppliers. All suppliers showed one common factor which was, all of them doing domestic installation more than other categories shown in the table. When comparing to Solar Shop 01 and 02, Solar Shop 03, 04 and 05 are newer to the business but as shown in the table even these companies are showing good stats. Furthermore, this table shows demand for the solar power in private offices and it is in a good condition.

4.2 INSTALLATION OF SOLAR ELECTRICAL SYSTEMS

As above explained data concluded demand for the solar power is increasing. Therefore, following are some of gathered data about solar customers who installed solar panel in their houses.

Table 3-Details of people who installed Solar Systems

House	Total cost of installing solar panels (Rs.)	Average amount of monthly electricity bill before installing solar system (Rs.)	Average amount of monthly electricity bill after installing solar system (Rs.)
House 01	650,000/=	12721/=	30/=
House 02	560,000/=	16,470/=	428/=
House 03	900,000/=	9992/=	30/=
House 04	1000,000/=	11353/=	1757/=
House 05	850,000/=	21443/=	30/=

According to the gathered data from these houses, above mentioned house no. three and four installed solar power system as selecting net accounting option. So, after installing solar system since then, they received Rs.2000- 3000 by government for generating electricity.

This table also shows the average amount of monthly electricity bill before and after situations of installing solar panel. According to the chart it shows there are huge differences between before and

after electricity bills. In house No. 01 it shows Rs.12,691 difference in electricity bills although in House No. 2 marked Rs.16428 difference as well. However, among all houses highest difference displayed in House No: 05 and it marked as Rs. 21,413. House number one, three and five showed only Rs. 30 amount after installing solar system in their houses.

Following chart shows gap between those electricity bills before and after more evidently.

Table 4-Estimation of recovered time-period of initial cost

House	Calculations of regarding monthly electricity bill	Estimated recovered years of initial cost
House No. 01	$12,721 \times 12 = 152,652$ $650,000 / 152,652 = 4$	4-5 years
House No.02	$16,470 \times 12 = 197,640$ $560,00 / 197,640 = 3$	3-4 years
House No.03	$9992 \times 12 = 119,904$ $900,000 / 119,904 = 7$	7-8 years
House No.04	$11,353 \times 12 = 136,236$ $1,000,000 / 136,236 = 7$	7-8 years
House No.05	$21443 \times 12 = 257,316$ $850,000 / 257,316 = 3$	3-4 years

XXX- Average amount of monthly electricity bill before installing solar system (Rs.)

XXXX-one year (12 months)

According to the above mentioned table 6, it proved calculating average monthly electricity bills, initial cost of installing solar system can be recovered in around 7-8 years but in house No. 3 and 4 since they installed net accounting system they can be recovered initial cost of installing solar panels in 6-7 years. by the way this table proved solar system is a cost effective energy efficiency solution and initial cost can be recovered in short period.

Table 5 -Additional details of solar systems customers

	House 06	House 07
Total cost of installing solar panels (Rs.)	1,100,000/=	1,100,000/=
Average amount of monthly electricity bill before installing solar panel (Rs.)	434/=	1972/=
Average amount of monthly electricity bill after installing solar panel (Rs.)	17180/=	15464/=
Loan instalment per month(Rs.)	17150/=	15590/=
Average amount for generation per month(Rs.)	12,048/=	---

When monthly electricity bills of the above-mentioned houses no. 06 and 07 are considered, they are quite different from other houses. It's because they have taken loans from CEB and installed solar power

system with net accounting. The average monthly electricity bill of house no.6 was 17,180 Rupees, comprising Rupees 17,150 of monthly loan instalment and Rupees 30 fixed charge. However, they received average amount of Rs. 12,048 per month for generating electricity. Therefore, to pay back the loan for the CEB, they have to pay around Rs.5000- 5500 per month throughout the payback period of five years. After 5 years, they will have to pay only Rs.30 per month (fixed charge) but they will get about Rs. 12,000 per month for the electricity generation.

Above described all conditions are applicable for the House No. 7 as well but their average amount for generation is not properly mentioned in their electricity bill. Hence, due to that reason calculation cannot be done accurately.

4.3 SUB-METERING A HOUSE

As gathered data from LECO, In Sri Lankan practices when sub-metering a house there are some rules and regulations which must consider. According to the Sri Lanka electricity Act No. 20 of 2009, To have two meters for each floors owner must physically separate both premises and wiring should be done separately.to explain the simply that each premises should be separated units. According to the tariff plan of CEB and LECO when house is sub-metered it total units divided into the two or three floors and then electricity bill will be reduced.

According to the rules and regulations of Electricity board, Domestic (D1) effective from 16th September 2017, it is proved that the total amount of electricity bills in sub metered house is less than total amount of electricity bill non-sub metered house even total consumed units are equal. Following details are from the sub metered houses.

Table 6- Details about sub-metered houses

House	July average Monthly electricity bill in two floors (Rs.)	August average Monthly electricity bill in two floors (Rs.)
House A	5589/=	7105/=
House B	727/=	706/=
House C	6814/=	8495/=

Above mentioned Houses, A, B and C are sub-metered houses. And also, House A and C rented their second floor to another family. House B rented their second floor few years ago. However, presently only one family living in that house.

Table 7 -Details about not sub-metered houses

House	July electricity bill (Rs.)	August electricity bill (Rs.)
House D	6561/=	7160/=
House E	6439/=	8132/=

This table shows details of not sub- metered houses. Only one family is living in these houses. As comparing detail of table 11 in House D and E, even when only one family is living, some monthly electricity bills of these houses are higher than A, B and C Houses and some of are quite equal. That means people who living in A, B and C Houses are getting benefits of sub-metering.

Furthermore, if A, B and C Houses are rented and owners of that houses didn't sub-meter their houses, both parties (owner and the rented) have to share the electricity bill and that can be unfair to both parties because the party who consume electricity less have to pay additional cost.

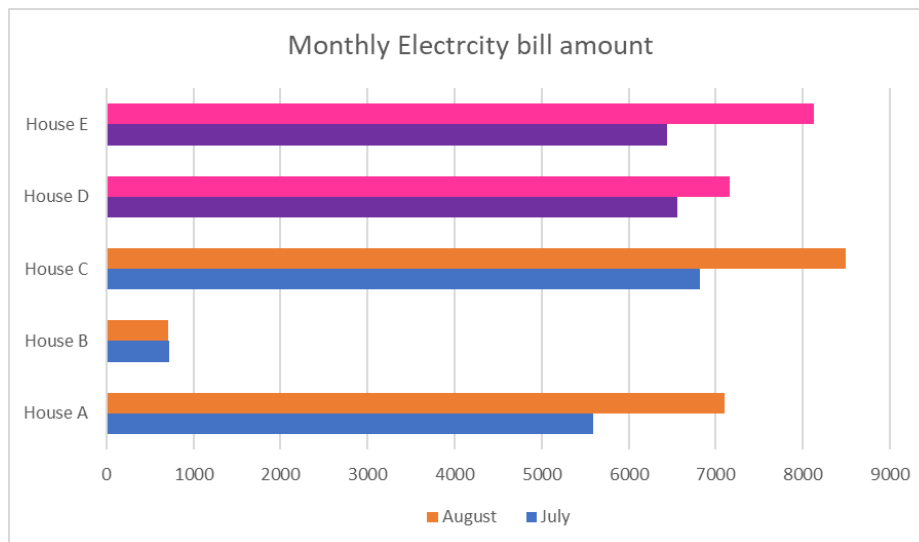

This chart shows gathered data about House A,B,C,D and E. main point of these chart is even there are two families living in House A and C their total monthly electricity bills are less than House D and E and some of bills are equal.

5. Conclusion and Findings

Electricity consumption is a common challenge any of country have to face. As a result of, the consumption of that form of energy sometimes becomes a problem because the generating capacity cannot match the demand. This study was covered areas of electricity consumptions in buildings. This study revealed considering the data gathered, the energy saving solution such as use of LED bulbs are cost effective when comparing CFL and other lighting systems. This study also revealed importance of sub-metering house and cost effectiveness of installing solar power system. Even though there is an initial amount of money to install these electricity saving methods, homeowners will often recover these costs in a short period of time due to the reduced energy expenses. This payback time can be short, taking only a few years. Saving electricity is not only for own well it is an immense contribution to the society as well. As demand for the electricity is increasing year by year it is necessary to save electricity as soon as possible.

6. References

- Agarwal, T. 2014. What are the Different Types of Lights in Lighting System?. Retrieved from <https://www.efxkits.us/different-types-of-lamps-in-lighting-system/>
- Central Intelligence Agency. 2018. The World Fact Book: Country Comparison Electricity - consumption. Retrieved from <https://www.indexmundi.com/g/r.aspx?c=ce&v=81>
- Daily news 2018. Solar Power Electricity In Sri Lanka Retrieved from <http://www.dailynews.lk/2018/01/31/features/141431/solar-power-electricity-sri-lanka>
- Daily news 2018. Sri Lanka's energy mix. Retrieved from <http://www.dailynews.lk/2018/05/14/features/150778/sri-lanka%E2%80%99s-energy-mix>.
- International Energy Agency 2018 Energy efficiency: Our work. Retrieved from <https://www.iea.org/topics/energyefficiency/>
- Matek, B. & Gawell, K. 2015. The Benefits of Baseload Renewables: A Misunderstood Energy Technology. The Electricity Journal. 28 (2). <https://doi.org/10.1016/j.tej.2015.02.001>
- McBride, B. 2017. Comparing LED vs CFL vs Incandescent Light Bulbs. Retrieved from <https://www.viribright.com/lumen-output-comparing-led-vs-cfl-vs-incandescent-wattage/>
- Ministry of Power and Renewable Energy (2017) Performance 2017 & Programme for 2018 Retrieved from <http://powermin.gov.lk/english/wp-content/uploads/2017/10/MoPRE-2017.2018-03-English.pdf>

Ministry of Power and Renewable Energy Sri Lanka (2017). Performance 2017 and Programmes for 2018. Colombo: Sri Lanka. Retrieved from <http://powermin.gov.lk/english/wp-content/uploads/2017/10/MoPRE-2017.2018-03-English.pdf>

Terry, N., Palmer, J., Godoy, D., Firth, S., Kane, T. & Wilson, A. (2013). *Further Analysis of the Household Electricity Survey: Lighting Study (Final Report)*. Cambridge Architectural Research Limited : UK.

The National Optical astronomy Observatory U.S. 2015. Types of Lights. Retrieved from https://www.noao.edu/education/QLTkit/ACTIVITY_Documents/Energy/TypesofLights.pdf

Wood, D. & Matulk, R. 2013. The history of the Light Bulb. Retrieved from <https://www.energy.gov/articles/history-light-bulb>

Samarawickrama, Sumanthri, et al (eds), 2018, "Sustainability for people - envisaging multi disciplinary solution": *Proceedings of the 11th International Conference of Faculty of Architecture Research Unit (FARU), University of Moratuwa, Sri Lanka, December 08, 2018* Galle pp. 182–189. ©

DESIGN APPROACHES TO REVITALIZE A CANAL FRONT: A CASE STUDY ALONG CHAKTAI COMMERCIAL AREA OF CHITTAGONG, BANGLADESH

SARAH BINTE HAQUE¹ & MAHDI MAHMUDUL HOQUE²

¹Chittagong University of Engineering & Technology, Chittagong, Bangladesh

²Studio 56 Architects, Chittagong, Bangladesh

¹arch.saraho26@cuet.ac.bd, ²mahdi.pulok@gmail.com

Abstract

Chaktai is one of the oldest commercial areas of Chittagong, the 'Business Capital' of Bangladesh. This site is adorned by the historic Chaktai canal which flows through the commercial area, contributing to the transportation network of commercial activities of this site. Chaktai canal front has also been served to the nearby residents as a waterfront public activity space. Unfortunately Chaktai is losing its past glory as a central business district (CBD) controlling food business all around Bangladesh. In recent years, the dilapidated condition of the canal has interrupted frequent commercial activities. Moreover, the canal front has become more inaccessible, unhealthy and uncomfortable public space because of the unexecuted planning proposals & mismanagement. Considering the local context, Chaktai canal front can be transformed into an enjoyable breathing space by redeveloping the canal front through proper planning solutions with surrounding community participation. The aim of this research paper is to identify the current state of Chaktai canal front to provide some sustainable approaches for its revitalization from an in-depth empirical research and survey. Both quantitative and qualitative methods are employed to generate primary data. Field visits and reconnaissance surveys have been conducted to assess the present status of the canal front. 30 respondents have been interviewed including local businessmen, commercial workers & surrounding area's residents to understand their perspective on public activity space. Findings from the survey show that the revitalization of the canal front will facilitate mobility, convenience for commercial activities and accommodate a vibrant social interaction space in future. This paper will propose some design guidelines for the improvement of present condition of the canal front which will in return help into the uplifting city's economic, heritage and cultural value.

Keywords: *Chaktai canal & canal front, Canal front revitalization, Commercial area, Social interaction space, Community participation*

1. Introduction

The pride of Bangladesh is its rivers with one of the largest networks in the world with a total number of about 700 rivers including tributaries, which have a total length of about 24,140 km. They consist of tiny hilly streams, winding seasonal creeks, muddy swamp and mostly Canals (*khals*) (BWDB, 2012). Canals are natural channels or artificial waterways, for water conveyance, or to service water transport vehicles, thus being an inseparable part of the development of any commercial area. 'Chaktai Commercial Area' is a traditional business hub in Chittagong. Most of the import-export business go on under the control of this business zone. Many types and genres of business system and activities are found here. The morphological development of the Chaktai commercial area of Chittagong city is based upon the Chaktai canal, where it functioned as the main transportation system. Once Chaktai canal front has also been served as a waterfront public space. General people living and working in the nearby areas such as Chaktai, Khatungonj and Asadgonj use the canal front spaces for easy circulation towards city, social interaction space provided with sitting or strolling purpose/elements as well as used for commercial activities. Pedestrian walkways with some adjacent green open spaces was a source of meeting, gathering or interaction for the surrounding areas' residents. But the situation is changed now. This canal is being encroached through decades and in recent time faces very poor condition near to its extinction. It serves only as a large drain for the city now. The unregulated establishments on the canal front areas have considerably reduced the spontaneous mobility of commercial activities and social interaction spaces. Illegal structures have blocked the canal front areas causing inconvenience to the loading-unloading of goods. It has also failed to serve as an interactive social space both for the

inhabitants of the surrounding areas and whole city. All these problems make this business district to become a subject to proper planning and design overlay. The issue of the waterfront became more prominent when this canal is ceased to be the major lifeline of the commercial area as well as its most important transportation mode. Some attempts to reviving the desired functionality of the business district had been taken so far, but those actually failed because these improper and unorganized attempts can't really solve the total problem. Except for a few (Hoyle, 2002, Latip et al., 2012, McCarthy, 2004, Nagpal & Sinha, 2009), little research has been done on canal front revitalization in the developing countries. This paper is going to discuss the current scenario of canal front development along the Chaktai commercial area and its potential as one of the elements that can contribute to the sustainable approach to city's ultimate development in the future. Pickett and Cadenasso (2008) showed that nature in cities contributes to better quality of life. Also the physical and psychological wellbeing of the residents is related to the quality of a physical environment (Berke et al., 2007, Van den Berg et al., 2007). By bringing people back to the canal's revitalized waterfront, a tangible sign of the continuing vitality may be provided. In doing so, the study aims at examining the existing situation, assessing causes behind the problems, inquiring about the liking and disliking of the stakeholders, and identifying possible solutions as an essential input towards arriving at appropriate planning decisions.

2. Issues facing the canal front of Chaktai commercial area

Chaktai canal is one of the partially man-made Main Drainage Channels & Waterway Transportation Hub of Chittagong city, which is about 6.9KM long. The width of the canal- starting from Bahaddarhat area of the city and falling into the Karnaphuli River at Chaktai - Chamrar Gudam (Tannery) Area was about 65 feet on an average, as per the RS (Revisional Survey) and 61 feet according to the BS (Bangladesh Survey) surveys conducted in Bangladesh. But now the width is barely about 45~50 feet, said sources at the Chittagong City Corporation (CCC).

Once regarded as the "Lifeline" for Trade and Commerce at the traditional business centres of Khatunganj and Chaktai areas in Chittagong, Chaktai canal has shrunk alarmingly due to encroachment over the years under the clutches of influential encroachers (Ashraf & Chowdhury, 2009). Chaktai - backbone of the sewerage system of the port city has now emerged as "sorrow of Chittagong", causing severe waterlogging not only in the rainy season but also during high tide in the Karnaphuli river as it cannot hold enough water and overflows its banks.

Also, this nearly seven-kilometre canal, stretching from Bahaddarhat to Chaktai, once helped navigating large ships & vessels laden with agriculture based perishable commodities (onions, garlic, rice, lentils, sugar, tea and spices), poultry feeds, hardware etc. has been clogged and choked by garbage, in addition to rampant encroachment. Due to sediment load from natural process of soil erosion, dumping of municipal & house hold solid waste, illegal encroachment of the bank side Chaktai has lost its original form & natural function of draining water. At present time Chittagong city faced more waterlogging situations in the rainy season than the previous times because of the bad condition of the major canals like- Chaktai, Mohesh, Rajakhali etc. These scenarios have created a massive effect on the open space beside the Chaktai canal. The waterfront has lost its significance and appeal to the eyes of general people and its vitality to the city life. The place that the public had cherished became a place that the public avoided and it was a great loss to one of the main assets of the city.

3. Canal front as public space- Literature survey

According to Gehl (2000), the quality of a public space is determined by whether all the three features (function, operation and spatial arrangement) are present in the location and whether they can satisfy the demands of the inhabitants. Public spaces in developing cities have different characteristics compared to public spaces in developed cities. When developed cities have started to pay attention on the qualities of their public spaces, most developing cities are still struggling with problems caused by the rapid rise of urban populations such as informal housing, poverty, health, and education problems which are reflected in the structures of the cities and the conditions of their urban spaces, including their public spaces (Miao, 2001, Gehl, 2010). Miao (2001) also highlights the unavailability of green spaces in developing cities. Green open spaces have become rare to find in the city center; people should go further away to enjoy green open spaces. In a developing city like Chittagong, the canal front along Chaktai commercial area can serve as a public interaction space to the surrounding area's inhabitants as well as functioning commercial activities. Typology and use of urban waterfronts are the topics of

the work by Maxmilian Wittmann (2008), who defined the basic functional uses of waterfront areas into the following categories:

Transport (road transport, rail transport, walking and cycling), social (linked with public facilities), function additional to housing and housing itself, recreation, industrial use and as complementary functions there are-junction specific social function.

From the perspective of urban design this functional division ensures the possibility of canal front of Chaktai canal for being used by general people. Gehl (2010) describes that the conditions of urban public spaces in developing cities are mostly under dimensioned and poor in quality. He suggests that it is necessary for developing cities to provide enough well-functioning free spaces for public activities. The revitalization of the canal front along Chaktai commercial area of Chittagong will thus encourage creating open and social space with a unique view of the city.

4. Study Area

The selected site of Chaktai Commercial Area is located in the South-East corner of the Chittagong City in Kotwali Thana & partially in Bakalia Thana. The historic Chaktai canal pierced through the site separating it into two separate zones- Asadganj and Chaktai-Rajakhali commercial zones. This site is surrounded by two canals on east and west, they are- Fishery Ghat canal (west) and Rajakhali canal (east). Chaktai canal stretches from Bahaddarhat area of the city and fall into the Karnaphuli River at Chaktai - Chamrar Gudam (Tannery) Area. It is situated just beside the Shah Amanat Bridge that connects the Northern and Southern parts of Chittagong on the bank of Karnaphuli River. The area is under city Corporation (Ward no.34 & 35). In Detail Area Plan (DAP) of Chittagong, the site is situated on DPZ-3 (Sadarghat-Chawkbazar). Chaktai commercial area is one of the oldest commodity hubs of Bangladesh. As the canal is about 6.9 Km long, only a portion (0.512 Km) has been taken for study ranging from the end of Khatunganj commercial district to the opening of Karnaphuli River. This zone houses about 3000 businesses and about 5000 warehouses along canal front and throughout the area.

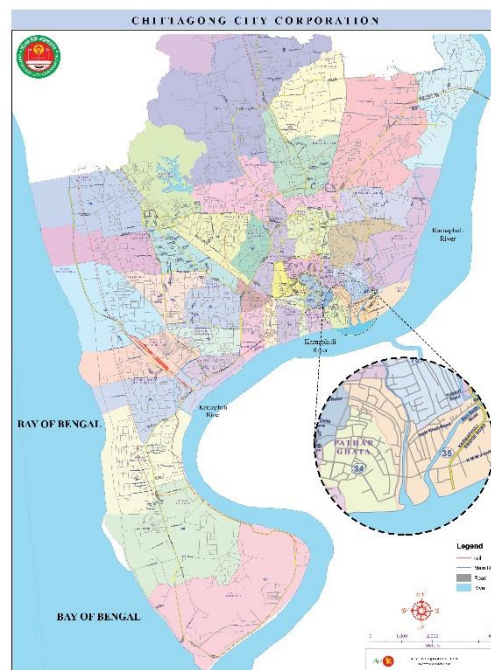

Figure 1, Ward Map of Chittagong City Corporation (Source: CCC)

The site is connected by both roads and waterways. Asadganj and Khatunganj road directly enter this site and are extended through south joining with the newly developed Marine drive road. Our study site is a commercial area that serves the needs of agricultural commodities including onions, garlic, rice, lentils, sugar, tea, spices and herbs etc. for the Chittagong city and also the country. In the past, large amount of business activities were accomplished by boats/vessels. This tradition still continues today but due to the increasing road network, waterway transport has been reduced. But that doesn't decrease the importance the canals at all. In a port-based city like Chittagong, Chaktai plays a vital role in mobilizing the trade and commerce.

5. Methodology

To understand the present situation of Canal front along the Chaktai Commercial area and to arrive at a planning and some design solutions to alleviate the problem the following methods were mainly utilized in completing the study:

- a) **Reconnaissance Survey:** Reconnaissance Survey is a preliminary survey, usually executed rapidly and at relatively low cost, prior to mapping in detail and with greater precision. Here, reconnaissance survey will conduct for gathering general information of the Chaktai Canal. Photo documentation and field-notes have aided this step of data collection. The main objective of the reconnaissance survey is to find out the actual condition of the canal front, management system in that area and preparing a graphical report of that identifies problem sources.
- b) **Questionnaire Survey:** Questionnaire survey will be conducted with the local residents of nearby area, business men and workers through a semi-structured Questionnaire. The aim is to collect their opinion about the importance of having a public activity space along the canal front.
- c) **Interview:** Interview will conduct with the stakeholder that includes permanent businessmen, ward commissioners as local governing body, workers and residents from surrounding area. A key Informant Interview(KII) also conduct with CCC, CWASA, CDA, BWDB's responsible body to know about the legal & management problem of the reclamation of the Chaktai canal.
- d) **Literature Survey:** A literature review helped to formulate and refine the concept of canal front development and further in-depth literature survey has been carried out thoroughly by going through Case studies from different countries, thesis reports, journal articles, conference proceedings, Government reports, books etc. in order to acquire knowledge on the past and present work done on the rivers and their banks in our country. This helped to reveal any planning approaches in formulating guidelines.

6. Discussion

Findings from the survey show the current condition of the canal front along the Chaktai commercial area as an alarming situation such as_

6.1. DETRIMENTAL CONDITION OF CHAKTAI CANAL

Boats carrying Goods get stuck in Chaktai canal during low tide. This Canal is losing Navigability due to Silt Deposition and Permanent Bottom at the Canal (which affects water flow), which is hampering frequent movement of Boats and incurring heavy loss in time and economy of this once busy commercial area. Thus, sedimentation on canal make it quite impossible for boats to function properly, thus hampering loading-unloading activities



Figure 2, Condition of Boats during low-tide time (Source: Author)

Furthermore, dump of Dirt, Domestic Waste, Toxic Waste from Commercial area on the Canal side roads and no proper Waste disposal system resulted in detrimental working environment for workers and businessmen.



Figure 3, Garbage Disposal along canal front blocks canal (Source: Author)

The consequence is detrimental. Chaktai canal, once considered to be the life-line of the city as the main drainage system for removing rainwater along with usual sewage outlet, has been choked with solid waste and filth along with encroachments causing overflow of rainwater flooding both sides from Bahadderhat to Chaktai Commercial Areas. The wholesalers in the Commercial space that house at least 3,000 businesses and more than 5,000 warehouses have to pass dull days over the monsoon period. They were claiming to be facing growing losses as many areas of Chaktai and their neighbouring Korbaniganj and Rajakhali areas have remained inundated for weeks. During every year monsoon, rainwater from the Karnaphuli River floods the shops and warehouses in the area through the various canals.



Figure 4, Water logging situation at rainy season (Source: Author)

6.2. EXISTING CANAL FRONT SITUATION

Unauthorized Building construction at canal front resulting in Canal width Reduction and lack of both Pedestrian Walkway & Vehicular Circulation. Walking through canal front has become difficult and Goods loading unloading from boats to truck is extremely complicated.

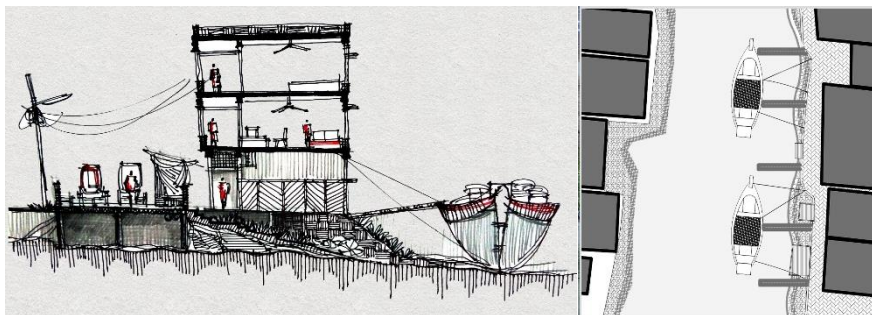

Figure 5, Illegal structures limiting pedestrian circulation (Source: Author)

Moreover, this situation is making it impossible for providing any kind of social interaction space along canal front. Lack of Harmony is seen between Commercial Activities along canal and Social Interaction between the people living in Chaktai Commercial Area. Once, the canal front used to serve as the hub of social interaction for the people of Chaktai. But over time it has lost its appeal as an Urban Open Space because of illegal and unplanned developments, no concern for Human comfort and no responsibility to environmental preservation.

Again, canal front has become the backside of the main commercial area as most of the buildings overlook the view of Chaktai canal. Thus the visual connection to canal front with the building structures is lost. The historical building fabric of Chaktai commercial area is also losing its significance.



Figure 6, Unplanned establishment destroying open spaces (Source: Author)



Figure 7, Chaktai commercial area overlooking canal front (Source: Author)

6.3. CHAKTAI CANAL RECLAMATION

The canal should be restored by widening the width and excavating waste sludge from the bottom, breaking the permanent R.C.C. bottom of the canal and increasing depth (which will help in flowing canal water simultaneously), so that it may function properly, ensuring relentless waterway traffic.

In addition, the warehouses and shops beside the canal get the direct advantage of loading and unloading materials/goods. But traders on the other side can't get direct access from the canal. Special design considerations are required for transporting good in such case from the canal front. For instance, Illegal and Unplanned buildings constructed on canal edge should be evicted thus restoring the open spaces along the canal, making rooms for an urban passage along the canal front. In that place, permanent loading docks/jetties should be constructed on the canal for ease of access from boats/vessels. Also Truck landing spaces must have to be provided for smooth transportation.

6.4. CANAL FRONT SPACE REVITALIZATION

The canal front walkway should be widened and be visually connected with the main road, so that it will be used for circulation and commercial activities. The buildings beside the walkway should be constructed/converted as canal facing warehouses/shops, same as the main road's frontage. It will also create sufficient environment for the canal front to be suitable for both functional commercial activities and Social Interaction between the residents and business houses and workers. Provision of Pocket Urban Parks, Fruit/Newspaper/Grocery shops, Food shops at certain intervals, shaded walking spaces, resting spaces for labours and amenities (public toilet, small community centre) will increase the living standards of the commercial space. Also provision of green spaces will help a

great deal to make this canal front more livable, once again. Moreover, the side streets/alleys connecting the canal access road and vehicular main road will be used as the access road for buildings in between them. They should have the minimum requirement of accessibility.

6.5. PEOPLE’S PERCEPTION

Nowadays this canal has become a mere drain for sewage. There is no canal based activities seen, no public open space/ community gathering space, no resting space for local labors, no community green spaces are located. It is making the canal front unusable day by day.

Respondents from the interview have mentioned various reasons for not using the canal front as previous time. Though they reminisced the past glory of this canal front as an active social space, now they tend to avoid the route. These reasons have been mentioned by respondents randomly chosen including residents of nearby area, workers and local business men.

Table 1, Causes behind the unused canal front (Source: Field survey 2017)

S/N	Causes	Frequency	Percent
1	Unhealthy Environment	28	93%
2	Lack of safety	14	47%
3	Absence of public amenities	27	90%
4	No sitting/resting space	15	50%
5	Unorganized loading-unloading	24	80%
6	Unusable pedestrian walkway	20	67%
7	Water logging	10	34%

6.6. COMMUNITY PARTICIPATION

Any revitalization project in a living city has to involve the local people to protect the heritage, especially when “problem defined by the political actors were misaligned with the community’s needs” (Morgia & Vicino, 2013). Therefore, participatory planning approach i.e people and private voluntary and community based organizations must be empowered and facilitated to participate. For example, waste collection network and disposal system has to be arranged in a community participation approach, where all the residents and business houses enable in keeping the place clean.



Figure 8, Proposals for revitalization of Chaktai canal front (Source: Author)

7. Conclusion

This paper discusses the issue of the canal front revitalization along Chittagong city’s most significant commercial area of Chaktai in the light of the current thinking about the potential of this waterfront. As Chittagong has a traditional development with a generic pattern in its growth, and not totally

planned, Chaktai-Khatunganj area is not designed properly as well. Most of the structures are temporary and some appear to be permanent being built in an undersigned and inappropriate manner along the Chaktai canal side. The problems of the area – regular clogging up of vehicular traffic, the unwanted distribution and chaos in pedestrian traffic make the situation worse. The canal is being failed to become a possible mean of transport for goods and people. In the past, the canal and canal front space was not given due considerations in the planning and design of the canal front of Chittagong. Over the course of time this canal front has lost its viability as a public waterfront to be enjoyed by general people. With little public space left in the highly dense Chaktai commercial area, the canal front can cater for social interaction and recreation space for the people working there. Most importantly increased and enhanced scope for social interaction and recreation helps improve the quality of life experience of the residents living nearby this area. In view of the significant contribution of the water front of Chaktai canal along the Chaktai commercial area, both in the morphological development of the area as well as its role in creating the scope of a social interaction place, it is of utmost important that the Canal front be given due considerations in the future development planning of the city. The convenience for commercial activities, proper drainage and canal front circulation must be ensured for the betterment of the whole city.

8. Acknowledgment

This research work is supported by B. Arch Final Year Studio Project (2015) of Author M.M.Hoque, Dept. of Architecture, CUET. The authors would like to specially thank the studio teachers of Level-5, Term-2, Department of Architecture, CUET for their valuable guidance.

9. References

- Ashraf M.A. & Chowdhury S.A., 2009, *Drainage Planning in the Cities Bangladesh: Case Study of Drainage and Water Logging in Chaktai Commercial area, Chittagong*, Journal of Bangladesh institute of planners, vol.2, pp 49-60.
- Berke, E. M., Koepsell, T. D., Moudon, A.V., Hoskins, R. E., & Larson, E.B. 2007, *Association of the Built Environment with Physical Activity and Obesity in Older Persons*. American Journal of Public Health, 97(3), 486-492
- GEHL, J. 2000 *Life between buildings: the use of public spaces* 1st.ed.Brno: Partnership Foundation p. 202, ISBN 80-858-3479-0
- Hoyle, B. 2000 *Global and Local Change on the Port-city Waterfront*. *Geographical Review*, 90(3), 395-417.
- Latip, N. S. A., Shamsudin, S., & Liew, M. S. 2012 *Functional Dimension at 'Kuala Lumpur Waterfront'*, *Procedia - Social and Behavioral Sciences*, 49(0), 147-155
- Nagpal, S., Sinha, A. 2009 *The Gomti Riverfront in Lucknow, India: Revitalization of a Cultural Heritage Landscape*. *Journal of Urban Design*, 14(4), 489 – 506.
- McCarthy, J. 2004 *Tourism-related waterfront development in historic cities: Malta's Cottonera Project*. *International Planning Studies*, p 43-64
- Miao, P. 2001 *Public places in Asia Pacific cities: current issues and strategies*. Dordrecht: Kluwer Academic Publishers, pp. 1-47.
- Morgia, L., & Vicino, T. J. (2013). Waterfront politics: revisiting the case of Camden, New Jersey's redevelopment. *Urban Research & Practice*, 6(3), 329-345.
- Pickett, S. T. A., & Cadenasso, M. L. 2008 *Linking ecological and built components of urban mosaics: an open cycle of ecological design*. *Journal of Ecology*, 96(1), 8-12
- Van den Berg, A. E., Hartig, T., & Staats, H. 2007 *Preference for Nature in Urbanized Societies: Stress, Restoration, and the Pursuit of Sustainability*. *Journal of Social Issues*, 63(1), 79-96.
- WITTMANN, M. 2008 *The phenomenon of the water element in the context of the development of contemporary cities* Shortened habilitation thesis. Brno University of Technology, p. 31, ISBN 978-80-214-3799-9.

Samarawickrama, Sumanthri, et al (eds), 2018, "Sustainability for people - envisaging multi disciplinary solution": *Proceedings of the 11th International Conference of Faculty of Architecture Research Unit (FARU), University of Moratuwa, Sri Lanka, December 08, 2018* Galle pp. 190–203. ©

A STUDY ON VISITOR PERCEPTION AND THEIR COGNITION OF CULTURAL LANDSCAPES: WITH SPECIAL REFERENCE TO THE TEMPLE OF THE TOOTH, KANDY

RANASINGHE E.¹ & SAMITHA M.²

University of Moratuwa, Moratuwa, Sri Lanka

¹erandeenavo@gmail.com, ²samithama@gmail.com

Abstract

Mankind has been remembered through history for their various victories, defeats and even for the cities and land that had been developed in the past. Hence, today we would witness such intricacies through Cultural Landscapes which tell the stories of people, events and places through time. This develops a continuation for the landscape and will be remembered generation after generation. This research aims on assessing the relationship between the cognition and the visual perception in the visitors at the Temple of the Tooth, Kandy. The study would involve in identifying the factors that attribute for the Temple of the Tooth to become a cultural landscape, to identify the cultural activities around the Temple of the Tooth premises and its vicinity and the cultural landscape elements which its visitors could recall. Moreover, the Temple of the Tooth, Kandy can be identified as a Continuing Cultural Landscape and is a World Heritage site identified by the UNESCO in 1988. Therefore, data related to the memory the visitors carry within them would be unveiled using cognitive maps of the Temple of the Tooth, Kandy where volunteers identified and marked the places they remember on a map prepared which was followed with a questionnaire to further identify the factors related to the cognition of the cultural landscape elements that causes the visual memory. The target group is selected using simple random sampling method. Priority has been given on the landscape elements and how cognition relates to them. The visual perception of visitors on cultural landscapes is analysed based on the Information Processing theory. This study has identified that the landscape of the Temple of the Tooth and its vicinity complies with visual perception theories and the cognition of such landscape would enhance once complied. It has been identified that evolution within a cultural landscape would assist it to become a continuing cultural landscape rather than being a dead spot of mere history.

Keywords: *Cultural Landscape Elements; Visual Landscape Perception; Cognitive mapping.*

1. Introduction

The history that we learn at school, stories narrated by elderly are some examples where the relationship of human and nature in the past is emphasised, unique from culture to culture. Landscapes that carry the remnants of the past could be identified as *Cultural Landscapes*. Therefore, we tend to visit such places to experience them in person.

The changing ideologies about Cultural Landscapes are witnessed around the world. Hence it is convenient to initiate discussions in Sri Lanka where, cultural landscape has been an unmistakable study area under geography and archaeology but not under landscape architecture. Therefore, it is important to create a foreground for landscape architecture related discussion.

Hence this study aims on an altered eye-opener. That is, what factors would affect the memories that are formed other than cultural influences. Yet the memories formed would remain for the rest of our lives. These memories would be deposited in our brain forming a cognitive or a mind map.

1.1 NEED FOR STUDY AND OBJECTIVES

In the preservation of these sites, soft landscape elements and hard landscape elements are used affecting the behaviour of the visitors in the cultural landscape. People would use the given pathways to reach their destination. Besides, there has not been reliable study on the above relationship. Hence the objectives of the study are as follows:

- To understand the Cultural Landscape of Kandy

- To identify the Elements in the cultural landscape of the Temple of the Tooth, Kandy
- To understand the cultural activities around the Temple of the Tooth, Kandy and their impact on the cultural landscape
- To understand the relationship between visual perceptions and landscape elements in the Temple of the Tooth, Kandy

1.2 LIMITATIONS OF THE STUDY

The study has been carried out as a requirement of four year bachelor degree program. Here the study has been limited only to the cultural landscape of Temple of the Tooth, Kandy. Since the composition and the extents of other cultural landscapes are large this limitation has been applied in order to study deeper into one case study. Again the large extent of the Temple of the Tooth premises and its vicinity area has been limited to seven sub-case study areas as explained later.

Time has been the most prominent limitation of the study since roughly four months were allocated which is insufficient. A group of 35 individuals were assessed and for more accurate information, more data is required.

Furthermore, the study was carried out only during day time. Therefore, night time functioning and the visual character are left out. To regulate the subjectivity of different user categories, regular visitors were volunteered for the study.

Considering the time factor and accuracy both, the cognitive maps and the questionnaire was to be completed by the same visitor. Not only that, the surrounding of the volunteers who contributed in the study could have been different at the time they were experiencing in the past that had caused the memory assuming that by interviewing the visitors within a specific location would discard the above fact.

1.3 RESEARCH OUTCOME

In this research, it has been identified that cultural aspects have helped in unveiling the true forms of the landscape of the Temple of the Tooth and its vicinity. It is expected that gradual evolution within a cultural landscape would assist it to become a continuing cultural landscape rather than being a dead spot.

In order to achieve the above outcomes the study has been conducted to identify the grey areas in the literature. Then, the Temple of the Tooth, Kandy has been identified as a cultural landscape and the criteria that would incorporate with its identification. With the use of a sound methodology the study has been concluded with recommendations for the future aspects of the study area as well.

2. Visual Perception and Cognition of Visitors on Cultural Landscape sites

In order to achieve above mentioned objectives it is essential to understand the studies that would have been conducted related to the study area.

2.1 VISUAL LANDSCAPE PERCEPTION

According to Hilgard (1915) in Kaplan and Kaplan (1978) perception has been identified as the process in which information is derived through senses, organized and interpreted. Likely there could be people who have never visited the Temple of the Tooth, Kandy but know the existence of the place. Hence there is a difference between knowing something and remembering something.

Perception would be the combination of what people feel and their memories. Wöbse (1982) conveys that the way we perceive landscape is transpired as a combination of objective facts, memories and expectations.

More than 80% of our sensory input is through sight (Porteous, 1996). This would lead to the fact that for this study only the visual perception had been considered.

According to Bourassa (1988, 1990), the perception of landscape could be determined by biological, cultural and personal components. It has also been understood as processing of information (cognitive), the feeling of emotions (affective) and people's preferences (evaluative).

However, findings of Ekman (1992) have raised the idea of similarities in expressions for similar emotions throughout the world. Therefore the perceptions which relates to visual perception could be compared within the selected case study area.

2.2 COGNITION

Cognition could be the way information is organized, stored, and recalled, that exhibits the effects of culture. (Murphy 1966, Goodenough 1970, Golledge and Stimson 1987 in Nassauer, 1995)

The journal article Landscape Perception: Research, Application and Theory, the authors have identified “the cognitive paradigm” as follows:

“The cognitive paradigm: *This involves a search for human meaning associated with landscapes... Information is received by the human observer and, in conjunction with past experience, future expectation, and sociocultural conditioning, lends meaning to landscape.*” (Zube, Sell, & Taylor, 1982)

2.2.1 Cognitive Mapping

A cognitive map has been identified as a mental representation of places (Tolman, 1948). Similarly, cognitive maps (Tolman 1948, Downs 1981, Garling et al. 1984, Golledge and Stimson 1987) could be specific to the individual, but many individuals’ cognitive maps would share certain features that could be compared.

“A cognitive map is a mental representation of the layout of one’s environment... For example, when a friend asks you for directions to your house, you are able to create an image in your mind of the roads, places to turn, landmarks, etc., along the way to your house from your friend’s starting point. This representation is the cognitive map.” (‘Cognitive Map definition | Psychology Glossary | alleydog.com’, n.d.)

Cognitive maps could either be drawn on a blank paper or marked on an empty map (where places are to be identified).

2.3 FACTORS INFLUENCING VISUAL LANDSCAPE PERCEPTION

For instance, farming villages are found to exist near water bodies, but they would build houses near the shore changing landscape character. Therefore, culture affects landscape.

Similarly, individuals change the appearance of the landscape by changing its form according to their taste and appeal. The extent to which people would influence on landscape perception could vary with the academic knowledge as described by Kent (1993) in Aoki (1999). Also, the interest towards the place could influence on individual landscape perception. According to Zube (1987), certain people who use the landscape are attracted to the landscape since they are interested in it, whereas others might use the landscape as they live nearby who have no further attentiveness in the landscape. Researches of Burke et al (2012) has shown that there is no substantial variance concerning gender. Hence the following theories have been associated.

2.3.1 Berlyne’s Arousal Theory

The theory refers that, environmental perception is related to the extent of engagement or uncertainty in the environment (Chang, 2009 in Kaymaz 2012). He has recognised four factors: complexity (variety of elements), novelty (presence of unique elements), incongruity (degree of miss-matching of elements) and surprise (occurrence of the surprising) (Ungar, 1999). Through the U-shaped hypothesis, it is suggested that an average degree of arousal potential has an encouraging outcome on preference and vice versa. (Martindale, 1996)

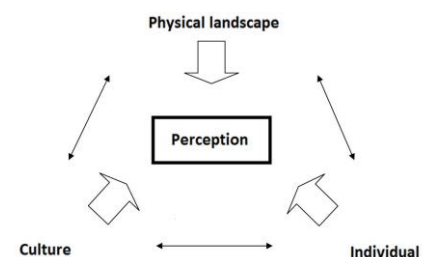

Figure 1: Factors that influence perception (Source: Heijgen, 2013)

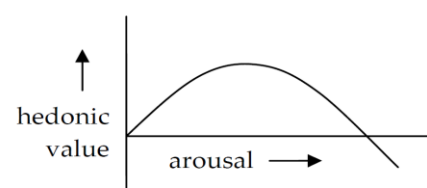

Figure 2: The hedonic value as an effect of the degree of arousal (Source: Martindale, 1996)

2.3.2 Information Processing Theory

According to the information processing theory by Kaplan, we would collect information from the surroundings recurrently through visual sense. It states that information is a resultant through the contents and the arrangement of the surroundings. Hence the variables are explained as below:

- Coherence: It refers to the order and organization of the elements it has been composed with. Kaplan et al. (1998) has suggested that coherence could be realised through repetition of themes and unifying textures; with a limited amount of contrast.
- Complexity: Complexity would discuss the degree of diversity of landscape elements. The more complex an environment could be, the more information it would involve.
- Legibility: The idea would be about placement. A person would feel secure and safe if landscape itself could bring forth clarity in which direction to pursue.
- Mystery: This would lead any individual to explore and a promise made to the visitor for more advanced or altered information in the landscape that has not been experienced. Kaplan et al. (1998) has proposed that a meandering path or vegetation that somewhat hinders the view could create mystery to an environment.

2.3.3 Topophilia

Tuan (1974) has focused about the cultural dimension of landscape preference in Topophilia Theory. It has been defined after the repeated occurrence of regular activities in a given place which would develop a strong sentiment towards the place within an individual. Therefore, this theory has been focussed on the historical factor of landscape perception.

2.4 LANDSCAPE ELEMENTS IN A CULTURAL LANDSCAPE

Cultural landscape elements could be identified mainly as “natural elements” and “human/anthropic elements”.(Baciu et al., 2010)

Cultural Elements of Vața area by Gavra and Crăciun (2010) has been are illustrated as below.

Table 13: Classification of Cultural Landscape Elements on Vața area according to its practical criteria (Source: GAVRA & CRĂCIUN, 2010)

Elements related to housing and household	Elements with religious significance	Elements related to agriculture	Elements related to forestry and industry	Trade related elements	Elements related to transport routes	Elements of interest, recreation and cultural elements
-traditional dwelling -house -villa -block of flats -store hay -shed -stable for cattle -summer house -cellar -gate and fence -bread oven -Flower garden -vegetable garden	-church -cemetery -cross on agricultural land	-agricultural land parcel -grassy ditch -pasture -hayfield -haycock -solitary tree -orchard	-forest -bush -water mill for grinding grain -distillery -sawmill	-fair -village store for selling various products	-asphalt road -causeway -unpaved road -King’s Road -path -wood deck -concrete and metal bridge -rail road -train station	-hotel -hostel -restaurant -bathroom tub and outdoor pool -Petrieved forest from Bessarabia -Prihodiste Cave -Bats Cave from Brasau -The Cure Spring of Ciungani -school -community centre

Similarly, Historical Landscape Elements (HLE) could be witnessed within/related to historically important sites. These would imply the uniqueness of the cultural landscape were the historical structures are not removed or changed. There could be contemporary and modern land use through

which the traditions and the relics have survived into existence up to today. (Bastian, Grunewald, Syrbe, Walz, & Wende, 2014)

Therefore, a cultural landscape element could be identified as a form of physical structure or form that binds people culturally.

2.5 CRITERIA FOR A LANDSCAPE TO BECOME A CULTURAL LANDSCAPE: ICOMOS, CULTURAL LANDSCAPES

According to the “Operational Guidelines for the Implementation of the World Heritage Convention”, “*Cultural landscapes are cultural properties and represent the "combined works of nature and of man"...*” (Centre, n.d.-b) Furthermore the document categories cultural landscapes as follows:

1. **Clearly defined landscape:** These are designed and created intentionally by man.
 - 1.1. **Garden:** an area related to or used by superior social statuses.
 - 1.2. **Park:** for public usage.
 - 1.3. **Gardens related to monumental buildings and/or ensembles:** court yards, front yards could fall under this category.
2. **Organically evolved landscape:** an outcome of an initial socio-cultural, administrative, and/or religious need later developed in response to the natural environment.
 - 2.1. **A relict or fossil landscape:** abrupt or gradual end of an evolutionary process.
 - 2.2. **Continuing landscape:** people are much involved where traditions are continued.
3. **Associative cultural landscape:** associated with a powerful religious, artistic or cultural aspect to the natural environment.

The *Outstanding Universal Value* (OUV) has been identified as part of the Operating Guidelines provided by United Nations Educational, Scientific and Cultural Organization (UNESCO) in the year 2017 at the world convention in France. In order to maintain the OUV of a specific heritage site the guidelines have conferred to maintain its conservation by protecting from adverse impacts.

3. Cultural Landscapes and its Relevance to the Temple of the Tooth

Sri Lanka consists of altogether eight sites listed under UNESCO World Heritage List as Cultural Heritage Sites (6): Ancient City of Polonnaruwa (1982), Ancient City of Sigiriya (1982), Golden Temple of Dambulla (1991), Old Town of Galle and its Fortification (1988) and Sacred City of Kandy (1988). Then as Natural Heritage Sites (2): Central Hills of Sri Lanka (2010) and Sinharaja Forest Reserve (1988) (Centre, n.d.-a)

The following criteria provides for the selection of the Temple of the Tooth, Kandy and its vicinity area as the best case study area.

- ✓ The Temple of the Tooth, Kandy has been pronounced as a World Heritage in 1988 extent by the UNESCO.
- ✓ The landscape under consideration can be identified as a continuing cultural landscape in Sri Lanka that has prevailed through history.
- ✓ Comprise of landscape elements in the vicinity that contributes to the cultural landscape.
- ✓ Despite of being a major tourist attraction point, the traditions still prevail.

3.1. HISTORY OF THE TEMPLE OF THE TOOTH, KANDY

The Tooth Relic was finally brought to its present resting place in Kandy, by King Vimaladharmasuriya I (1592-1603). It is believed that the current building called the Natha Dewalaya could have been the first building to shelter the tooth relic. During the reign of King Sri Wickrama Rajasingha, (1798 – 1815 A.D) the front section with the Paththirippuwa (Octagonal building) and the moat were constructed by Devendra Moolacarya, the Architect. (‘Temple of the Tooth’, n.d. and Gunawardana, n.d.) The king had called the Kandy Lake as “*Kiri Muhuda*” which implies white-sea.

The Temple of the Tooth has miraculously survived from the attacks in 1989 by the Janatha Vimukthi Peramuna and in 1998 the bombing by the Liberation Tigers of Tamil Eelam. (‘Temple of the Tooth’, n.d.) Currently the sacred city has been conserved and preserved under the Department of Archaeology

with the ownership of the Diyawadana Nilame Pradeep Nilanga Dela Bandara. Each Dewalaya are under the respective Basnayake Nilames.

3.2. CULTURAL EVENTS AROUND THE TEMPLE OF THE TOOTH, KANDY AND HOW THEY AFFECT THE LANDSCAPE

Bhikkhus of Malwatte chapter and Asgiriya chapter conduct daily worship in the inner chamber of the temple (*Wadasitina Maligaya*) performed at dawn, at noon and in the evenings within the Temple buildings. A symbolic bathing of the relic is conducted with an herbal preparation made from scented water and fragrant flowers called *Nanumura Mangallaya*. Prior to each ritual the drums are played at the drumming hall which is called the *Thewawa*. Out of the cultural events the *Esala Perahera* (procession) has the highest value and many gather to witness the procession on to balconies that have been preserved along the procession pathway.

Observations could be made that the visitors tend to gather near buildings where the rituals commence.

3.3. METHODOLOGY

The methodology involves in a preliminary study to familiarise with the study area followed by formation of a suitable questionnaire, collecting respective data and their analysis.

Through the preliminary study the context and the site area were identified where, few visitors were interviewed to establish clear understanding. Then, cognitive mapping method was used to identify landscape elements within the cultural landscape using the second method along with a questionnaire. Data collection was carried out orally with 35 randomly selected individuals who volunteered for the assessment under 7 areas (5 volunteers from each area), which were; Mahamaluwa area, Queen's Bathing Place (Biso Ulpen Ge) area, Lower terrace area near Paththirippuwa and Mahawahalkada, Magulmaduwa area, Dewala area, around the entrances to the Temple of the Tooth premises and around Bahirawa Kanda Buddha Statue. The study areas are denoted on a map in Annexure 02.

The questionnaire comprises of questions aimed on general, memory of the visitors and on the visual perception of the visitors. Further questions would assess the visitors' perception in relation to their memory. Questions related to the image sheet assisted in identifying visual intake. (Images contain views towards the Temple of the Tooth premises from the Bahirawa Kanda Buddha Statue (C) and Royal Park (D); view across the Mahamaluwa (A); view across the lower terrace towards the Mahawahalkada (main entrance) with a queue of visitors (B); view through the iron fence (E); and the view towards the New Entrance facing the Queen's Hotel (F) as illustrated in Annexure 03)

Further questions were formulated to discover on future appeal the visitors hold towards the landscape setting of the vicinity area of the Temple of the Tooth's cultural landscape.

4. Study of Cultural Landscape in vicinity of the Temple of the Tooth, Kandy

The cultural landscape spaces within the Temple of the Tooth, Kandy and its vicinity can be categorized into three categories regarding their compositions: Natural spaces, built spaces and mixed spaces.

Furthermore, cognitive mapping has identified the following list as Landscape Elements in the descending order:

Table 14: Identified Landscape Elements (implied by the author)

Element name	Built	Natural	Mixed
1. Magulmaduwa (Ceremonial Hall)	x		
2. Nuwara Wewa (Kandy Lake)		x	
3. Mahamaluwa (Main garden)			x
4. Queen's Hotel	x		
5. Elephant Museum	x		
6. Temple of the Tooth	x		
7. Vishnu Dewalaya			x
8. International Buddhist Museum	x		
9. Raja Waasala (Royal Palace)			x
10. Paththini Dewalaya	x		

11. Udawatte Forest Reserve		x	
12. Paththirippuwa (Octagonal Building)	x		
13. Natha Dewalaya	x		
14. Seema Maalakaya (King's Pleasure House - Island)			x
15. St. Paul's Church (Anglican)	x		
16. Flower stalls	x		
17. Biso Ulpen Ge (Queen's Bathing Place)			x
18. Maligawa bus stop	x		
19. Moat	x		
Element name	Built	Natural	Mixed
20. Tea Planters' Foundation fountain	x		

At the same time the respondents were questioned on their preference over the current environment or the older environments as they remember (See annexure 04). However, almost every visitor preferred the area after conservation and further expressed a positive attitude towards conservation of historical monuments and landscape.

According to the data obtained it could be concluded that 63.3% of the visitors at the Temple of the Tooth relic are from different parts of the country including four foreigners; where two were from China, and two from Germany and USA. Hence the Temple of the Tooth has a foreign visitor attraction of 11%. On the contrary $\frac{1}{4}$ of the foreigners had a clear knowledge on the importance of the area and identified as a Cultural Landscape.

86% preferred the location they were assessed at. 43% of the visitors were found to visit the cultural landscape in Kandy whenever possible. The people who visited daily were only 9% who work nearby or who use the Temple of the Tooth as a shortcut. When considering the reason for visit, 54% involve in religious activities whereas 17%, 14% and 15% involve in cultural, commercial and educational activities respectively. Moreover, a different set of reasons were assessed including meeting friends (25%), relaxing and meditation (27%), as a shortcut (18%) and pilgrimages (30%).

When considering the composition of landscape elements 64% of the users preferred mixed landscape characters and 25% preferred natural characters. The built forms which were preferred consisted of distinct artistic value.

40% of the visitors from the Mahamaluwa area have felt the space busy whereas another 40% have felt the area relaxing. Others were neutral. The visitors have given positive feedback on both visual appeals and spatial activeness.

Visitors have been more relaxed around the Queen's Bathing Place. Similarly the spatial activeness has been identified to be positive here. However, their visual appeals have not been similarly positive as 20% had felt the area less attractive due to the fence.

Only 20% of the visitors have responded positive towards the busyness of the lower terrace area and they have not encouraged on the visual appeal. However, the special activeness has been identified to be positive by 60% of the visitors.

The entrances, according to the study have been identified more visually appealing and active yet an entry feeling was not identified. Observations made clear that small groups of visitors would gather around the entrance areas on other reasons.

The visitors at the Magulmaduwa area have identified the area more relaxing including students who came for academic discussions, parents waiting for tuition classes to finish, and even visitors who stop at the Magulmaduwa to rest. 60% have responded that the Magulmaduwa area as a relaxing area whereas 20% each have noticed the area to be busy and neutral respectively. 80% prefer the view. 40% have felt neutral towards the activities around it and 60% have been active around the Magulmaduwa area.

Sensation at the Bahirawa Kanda area seems neutral since 40% have seen the area as busy, another 40% as relaxing and the rest of the 20% neutral. All respondents have identified this area as a visually appealing one. At the same time the activeness has been identified to be vibrant around the area.

A similar situation has been revealed from the Dewala area to that at the Bahirawa Kanda Buddha Statue area. Neutral sensation, attractive and vibrant could be the summary of the above responses.

Around 8.6% of the visitors, who have had less knowledge on the order of the area and who considered that the order is not necessary, were categorised as neutral. The rest have emphasised the importance of the coherence of the landscape elements.

Even for complexity the visitors have provided comparatively positive responses with 82.86% completely positive about the complexity of the Cultural Landscape and 17.14% with low understanding of the complexity of the area.

According to statistics the order of the preferences was A, C, D, B, F and E.

31.43% of the visitors have identified that finding the way through the Temple of the Tooth premises is quite difficult. Most of them were new to the surrounding or were not familiar with the environment and majority preferred the available degree of legibility in the landscape. Visitors have sensed mystery around the Dewala area entrance (71.43%) higher than the main entry area (68.57%).

No responses were given for drastic development changes in the cultural landscape of Kandy in the future. Almost 63% of the responses were pro for slight changes. Around 26% preferred no interruption over the existing landscape character.

5. Impact of the Cultural Landscape on Visitors

However, people recognise the Temple of the Tooth as a cultural landscape. When further questioned on the idea “why do they visit the place occasionally?” The responses were “faith”, “honour” and “devotion” for the religion. Therefore, one could argue that a continuing cultural landscape should have a religious background to be spontaneous. This realises the topophilic nature of the visitor perception which would be how much people relate to historical events and experiences related with the area.

According to the visitor feedback from areas such as Biso Ulpen Ge area and Magulmaduwa area, one could identify that out of the sub-case study areas, the visitors have identified the Temple of the Tooth premises as more sensational or in other words relaxed. Visitors in areas such as Mahamaluwa area, Bahirawa Kanda area and Dewala area have identified more neutrality since similar responses have been collected for both positive as well as negative further including a smaller percentage on neutral. The areas recognised as much busy were the Entrance areas and the Lower Terrace areas.

Visitors have found that areas with mixed landscape elements to be visually appealing out of which have more soft landscape elements such as trees and water. In this case visitors in areas such as Mahamaluwa area, Entrance areas, Bahirawa Kanda area and Dewala area have identified the cultural landscape under study only as a positive appealing landscape. 20% of the visitors have considered the Biso Ulpen Ge area as less attractive due to the heavy paving and the iron fence separating the Temple of the Tooth premises and the archaeological building at the edge of the lake. This could imply that the visitors expect in experiencing a particular place to its utmost level and if not possible they would adapt into the surrounding. (Jacob, 2006)

6. Conclusion

Sri Lanka, while having eight sites identified under the World Heritage List, more attention must be given on expanding a similar importance towards other Cultural Landscapes that are poorly recognised. This would eventually result in more tourism and heritage awareness for the locals. In return, much favourable image could be created concerning the economy of the country as well.

Regardless of limitations of time and scope mentioned before, the results have demonstrated that the Temple of the Tooth, Cultural Landscape have conformed to coherence, complexity, legibility as well as mystery.

The cognition level of the people demonstrated to be well notified with the fact that the area has been conserved and that the landscape is of much value. Most of the elements that were remembered were either with unique views and vistas or with a strong cultural background.

It has been clear that with the manipulation of the visual perception of a visitor, the memory too could be indirectly influenced.

From the above findings it has been found that for a cultural landscape to become a continuing landscape the traditions and the cultural belonging alone will not satisfy. The visual appeal should be maintained through well planned and monitored programmes. Slight changes on the surroundings such as technological facilities and amenities too should be considered.

Therefore it is best to recommend further investigation regarding the cognitions of the visitors based on gender, social status or background, etc. Finally, this study could be considered as another initiative for further studies regarding cultural landscapes within Sri Lanka.

7. References

- 2013Biblio_Cultural_landscapes.pdf. (n.d.). Retrieved from [https://www.Aoki, Y. \(1999\). Review article: Trends in the study of the psychological evaluation of landscape, Landscape Research, 24, 85-94.](https://www.Aoki, Y. (1999). Review article: Trends in the study of the psychological evaluation of landscape, Landscape Research, 24, 85-94.)
- Aoki, Y. (1999). Review article: Trends in the study of the psychological evaluation of landscape, Landscape Research, 24, 85-94.
- Baciu, N., Mihaiescu, R., Muntean, O.-L., Stănescu, C., Rosian, G., & Malos, C. (2010). Elements of the Cultural Landscapes as a basis for Tourism Development. *International Symposium Research, Education, Development*, 619–625.
- Bastian, O., Grunewald, K., Syrbe, R.-U., Walz, U., & Wende, W. (2014). Landscape services: the concept and its practical relevance. *Landscape Ecology*, 29(9), 1463–1479.
- Bureau of the World Heritage Committee. (1999). *Report of the Rapporteur* (Twenty-third session No. WHC-99/CONF.204/15) (p. 97). Paris, UNESCO Headquarters, Room X: UNESCO. Retrieved from <https://whc.unesco.org/archive/1999/whc-99-conf204-15e.pdf>
- Baciu, N., Mihaiescu, R., Muntean, O.-L., Stănescu, C., Rosian, G., & Malos, C. (2010). Elements of the Cultural Landscapes as a basis for Tourism Development. *International Symposium Research, Education, Development*, 619–625.
- Bastian, O., Grunewald, K., Syrbe, R.-U., Walz, U., & Wende, W. (2014). Landscape services: the concept and its practical relevance. *Landscape Ecology*, 29(9), 1463–1479.
- Bourassa, S.C (1990). A paradigm for landscape aesthetics. *Environmental Behaviour* 22 (6), 787-812
- Bourassa, S.C. (1988). Toward a theory of landscape aesthetics. *Landscape Urban Plan.* 15, 241-252
- Burke, A. Kandler, A. Good, D. (2012). Women who know their place; sex-based differences in spatial abilities and their evolutionary significance. *Human Nature*, Volume 23, Issue 2, pp 133-148
- Centre, U. W. H. (n.d.-a). Sri Lanka. Retrieved 8 August 2018, from <https://whc.unesco.org/en/statesparties/lk/>
- Centre, U. W. H. (n.d.). The Operational Guidelines for the Implementation of the World Heritage Convention. Retrieved 27 July 2018, from <https://whc.unesco.org/en/guidelines/>
- Darwin, C. (1965/1872). *The expression of emotions in man and animals*. Chicago: Chicago University Press.
- Eiter, S. (2010). Landscape as an area perceived through activity: implications for diversity management and conservation. *Landscape Research*, 35:3, 339-359
- Ekman, P. (1992). An argument for basic emotions. *Cognition and Emotion*, 6, 169-200.
- Features | Online edition of Daily News - Lakehouse Newspapers. (n.d.). Retrieved 20 August 2018, from <http://archives.dailynews.lk/2009/03/30/fea01.asp>
- Gowripalan, S. (2012, February 27). Amudu: Sri Dalada Maligawa or Temple of the Sacred Tooth Relic, Kandy ...OLD RARE PICTURES. Retrieved 20 August 2018, from <http://amudu-gowripalan.blogspot.com/2012/02/sri-dalada-maligawa-or-temple-of-sacred.html>
- Gunawardana, V. D. S. ed. (n.d.) *Dalada Siritha*. Colombo, Sri Lanka. Samayawardana Poth Hala.
- Howard, P.J. (2011). *An introduction to Landscape*. Ashgate.
- Jacobs, M.H. (2006). *The production of mindscapes: a comprehensive theory of landscape experience*. Thesis, Wageningen
- Jessel, B. (2006). Elements, characteristics and character; Information functions of landscapes in terms of indicators. *Ecological Indicators* 6, 153-167
- Kaplan, R. & Herbert, E.J. (1987). Cultural and sub-cultural comparison in preferences for natural settings. *Landscape and Urban Planning*, 14, pp. 281-293
- Kaplan, R. and Kaplan, S. (1989). *The experience of Nature: A Psychological Perspective*, Cambridge: Cambridge University Press
- Karmanov, D. (1999). *Feeling the Landscape: Six Psychological Studies into Landscape Experience*. PhD thesis Wageningen University
- Lowenthal, D. (1985). *The Past is a Foreign Country*, Cambridge University Press, Cambridge.
- Macia, A. (1979). Visual perception of landscape: sex and personality differences, in: *Our National Landscape*, pp. 279-285 (Berkeley Pacific Southwest Forest and Range Experiment Station).
- Nassauer, J. I. (1995). Culture and changing landscape structure. *Landscape Ecology*, 10(4), 229–237.
- Nijhuis, S. Lammeren, R van. Hoeven, F van der (2011). Exploring the visual landscape: advances in physiognomic landscape research in the Netherlands. *Research in Urbanism Series*, Volume 2.
- Oxford dictionary (2013a). Perception. Retrieved from: <http://oxforddictionaries.com/definition/perception> (accessed 12 July 2011)
- Perera, B. (n.d.). Temple of the holy tooth, Kandy 1905. Retrieved 20 August 2018, from <http://lankapura.com/2010/06/temple-of-the-holy-tooth-kandy-1905/>
- Ran Avuda Mandapaya of Kandyan Kingdom. (2013, October 22). Retrieved 20 August 2018, from <http://amazinglanka.com/wp/ran-avuda-mandapaya/>
- Temple of the Tooth. (n.d.). Retrieved from http://www.wikiwand.com/en/Temple_of_the_Tooth

- Tolman EC (1948) Cognitive maps in rats and men. *Psychological Review* 55: 189–208.
- Tuan, Y-F. (1971). Geography, phenomenology, and the study of human nature. *Canadian Geographer – Le Géographe Canadien* 15 (3): 181–192.
- Ungar, S. (1999). Environmental perception, cognition and appraisal. *Environmental Psychology 4 Lecture Notes*, Glasgow Caledonian University, Scotland.
- Wöbse, H.H. (1982). Landschaftsästhetik. Gedanken zu einem einseitig verwendeten Begriff. *Landschaft + Stadt* 13 (4), 152-160.
- Zube, E.H. (1987). Perceived land use patterns and landscape values, *Landscape Ecology*, 1(1).
- Zube, E. H., Sell, J. L., & Taylor, J. G. (1982). Landscape perception: research, application and theory. *Landscape Planning*, 9(1), 1–33.

Annexure 01



Annexure 02



Annexure 03 (Image Sheet)



A



B



C



D



E



F

Annexure 04 (Old images)



Temple of the Tooth in 1940s-50s



Ceylon Kandy Lake in 1870s

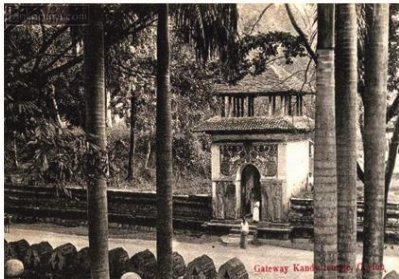

Natha Dewalaya entrance during late 1800s with Diyawel bamma (Wavelike wall)



Temple of the Tooth before restoration of the Moat



View across the Kandy Lake during 1800s



View from the Royal Palace Park during 1800s

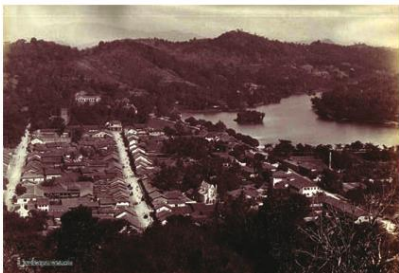

View of the Kary city during 1800s with the Temple of the Tooth at the far end



Biso Ulpenge during 1900s



Temple of the Tooth in 1800s

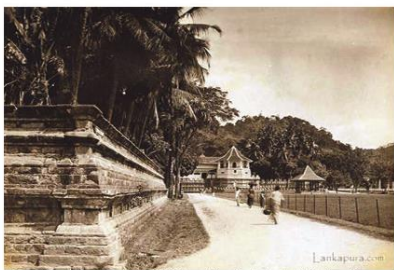

Temple of the Tooth in 1894 originally take by William Henry Jackson for the World Transportation Commission

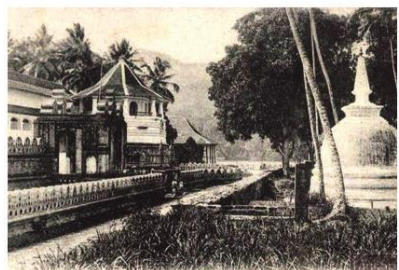

Temple of the Tooth in 1900s

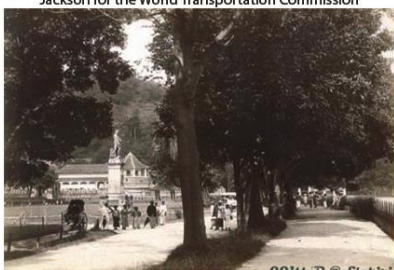

Ward street, Kandy in 1920s now called as Dalada Veediya

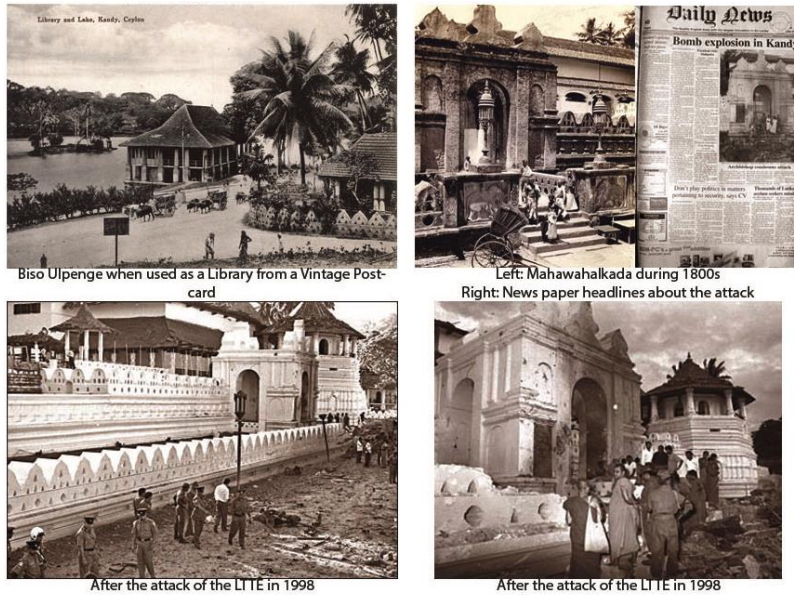

Table 15: Responses of the visitors towards current and old landscape

Location	old	%	new	%
Temple of the Tooth	11	31.42857	27	77.14286
Paththirippuwa (Octagonal Building)	20	57.14286	21	60
Mahamaluwa (Garden Area)	8	22.85714	30	85.71429
Magulmaduwa (Ceremonial Hall)	3	8.571429	31	88.57143
Raja Waasala (Royal Palace)	5	14.28571	23	65.71429
Vishnu Dewalaya	19	54.28571	27	77.14286
Mahawahalkada (Main entrance)	4	11.42857	4	11.42857
Biso Ulpen Ge (Queen's Bathing Place)	6	17.14286	16	45.71429
Natha Dewalaya	21	60	21	60
Paththini Dewalaya	23	65.71429	23	65.71429
Stupa	4	11.42857	4	11.42857
Bodhi trees	7	20	7	20
Queen's Hotel	22	62.85714	30	85.71429
Udawatte Forest Reserve	20	57.14286	20	57.14286
Kandy Lake	34	97.14286	34	97.14286
Island (King's Pleasure House)	5	14.28571	21	60
Eth Veediya (Elephant yard)	5	14.28571	12	34.28571
Raja Veediya (King's Street)	5	14.28571	5	14.28571
Walakulu bamma (Clouds Wall)	7	20	35	100
Location	old	%	new	%
Colamba Veediya (Colombo Street)	10	28.57143	3	8.571429
Ran ayudha mandapaya (Royal Goldsmith)	0	0	7	20
Median	8	22.85714	21	60
Maximum	34	97.14286	35	100

Samarawickrama, Sumanthri, et al (eds), 2018, "Sustainability for people - envisaging multi disciplinary solution": *Proceedings of the 11th International Conference of Faculty of Architecture Research Unit (FARU), University of Moratuwa, Sri Lanka, December 08, 2018* Galle pp. 204–211. ©

RELEASING THE BARRICADES: REINTEGRATING CENTRAL JAIL THROUGH 'PLACEMAKING' IN OLD DHAKA

NOSHIN SIARA PROMY. A¹, SHAMMI AKTER KEYA. B²

¹Khulna University of Engineering & Technology, Khulna, Bangladesh

²Rajshahi University of Engineering & Technology, Rajshahi, Bangladesh

¹noshinpromy@gmail.com , noshinpromy@arch.kuet.ac.bd, ²keya0801048@gmail.com

Abstract

Jail is an essential organization to establish law and order in day to day functioning of a state. Tracing jail making and its evolving timeline reflects a society's social and political history. 'Dacca Jail' has been no exception since its inception in the early 19th century and later updated to central jail in 1879 (Muntasir Mamun, 2000, 90). Central jail located at the north of Chawk bazaar in Old Dhaka carries the glorious testimony of Colonialism, dating back to Mughal era as an al-legged site for fort and mint (takshal). It has been existing as a barricade in the central heart of old Dhaka detaching it from its surroundings by high perimeter walls but spatially being as integral part of morphology and infrastructure of old Dhaka. The recent government decision of relocating the overcrowded central jail has paved the way towards reintegrating the vacated area within its immediate surroundings with the far-fetched, multi-faceted implications for the greater Old Dhaka. The first urban sprawl along the river Buriganga hosts the old quarters of Dhaka city rich in history and heritage which sadly now have the highest residential density in the country. This old part of the city lacks breathing places like open spaces and parks which estimates only 17 acres for over 10 lacs of people. This dire need of locality can be addressed by sensitize reintegration of the vacated site within the framework of heritage management and involving the outdoor public realm in the way of 'place making' whose inspiration referents coming from the living and localities of Old Dhaka. This paper focuses on the sequential process of place making on the basis of urban morphology analysis of Old Dhaka and Central jail for the betterment of the locality and the city.

Keywords: Jail, Old Dhaka, Reintegration, Heritage site, Open Space, Place Making

1. Introduction

Architectural structures and urban places which because of their inherited functions and features often survive for centuries, testifies the glories of the basic monuments of the past and the cultural development of the entire nation. Some historic places are not only evidence of its historic past but also give credence to the political significant interfolds. Situated in the main heart of the traditional Old Quarters of Dhaka, Central Jail holds the history dating back from the pre-mughal period to the ordinance passed in colonial period.

Government recent decision to relocate the age old central jail of Bangladesh arises the dilemma to the future possible reuse of this huge area in the rich urban fabric of Old quarters. In response to the widespread agreement that urban areas must change, or they will stagnate paves the thought to the issues about which possible way it could be reused, how it can be reintegrated with the surroundings and how its age old historic dimensions can be preserved?

The changing pattern of land use produces many blockade heritage areas which may rise an important urban design problems. These areas actually constitute the majority of "lost spaces" defined by Trancik (1986). In the recent few decades, the architectural intervention and redevelopment of these abandoned blocked historic areas has become an thoughtful field of urban design problem and the reintegration of these historic sites to the urban context has been brought into the spotlight.

For the dense urban setting like Old Quarters, the vacant historic site of Dhaka such areas might be illegally encroached, heritages may demolished and the context may fully violated. This reintegration

approach has a particular importance due to historical and political value of these historic Central Jail Complex which can help local communities to define their character more clearly by providing a strong link between past, present, and future and by strengthening the sense of belonging. The reintegration will help promoting a more desired image of public place since historic places with sociopolitical significance contribute immensely to the attractiveness, distinctiveness, and identity of places. In recent years, urban design have started to emphasize city's unique characteristics via bringing their historical values into the forefront by transformation of unoccupied heritage with new functions and making accessible to public realm accordingly. There are various approaches like transforming and re-integrating, or transforming and still in the integration process to the urban setting.

2. Background

Historic sites can be used as a tool to ensure breathing ground in an over populated urban context ensuring proper access, activity, safety and security. The lost piece can be bring back to the context by reintegrating in different levels of social, economic, political and cultural relationships in urban areas. At the local level, reintegration can resulted in increased surveillance and regulation of public space. Certain points for public space within the locality developing in the past historic spaces of important buildings or places in Old Quarters which carry historic importance can ensure healthy urban practice in the city.

Dhaka Central Jail, the oldest and biggest Jail in Bangladesh was built inside the fort in 1788 during the rule of East India Company which later was converted into the Jail. Dhaka Central Jail was built on 36.76 acres of land. The area within the perimeter wall measures 17.55 areas of land and outside 19.21 acres of land. There are- 48 wards,12 cell building, 233 rooms in the cells, 5 kitchens,6 work sheds,4 training sheds for maintenance work, 1 jail bakery, 1 daycare center and a multipurpose shed inside the jail compound. The High peripheral wall separates the jail from the locality. In spite of being separate, it has become a part of the surrounding in a long course of time. Though the environment inside the prison is not the part of the society but the peripheral wall makes a relation with its surrounding.

This paper focuses on the reintegration problem of this blockade piece of penitentiary with its immediate settings rather than the transformation itself in today's cities. Therefore, this study aims to explore the value of blockade historic sites as a component of the urban setting and how their reintegration to the city impacts on the image of the city as an urban problematic.

3. Objectives

The objective of this paper is to identify; the necessity of preserving the socio-political significant history of a nation,

- the necessity of preserving the socio-political significant history of a nation,
- the necessity of open space in organically evolved Old Quarters of a city,
- the process of reintegration to solve the evolving need of addressing the vacant historic site,
- the importance of urban space in historic cities and some designed implementation of public space in the context of Old Dhaka,
- the failure of Old Dhaka in successful place making and historic preservation.

4. Methodology

The study was conducted through content analysis and site analysis;

- Content analysis: Relevant research works, books and literature were reviewed to get a general overview how historic sites are reintegrated in city fabric to serve the aspiration of local communities where it belongs.
- Site analysis: Through the survey of some particular areas of Old Dhaka and the detail survey of Dhaka Central Jail the use and impact of these sites over the period of time is identified. Its intermediate setting and needs of the locals are studied.

5. Literature Review

5.1. HISTORIC EVALUATION OF CENTRAL JAIL

The Central Jail bears a legacy more than 400 years old with history and context of Old Dhaka which proves that many important structures and architectures flourished all over the Old Dhaka throughout this timeline. Prior to 1608, before the arrival of Mughals the Jail area was used as Afgan Fort ruled by the governors descending from the Delhi Sultanate. From 1608-1764 during Mughal Period Nawab Ibrahim Kha built there a fort that was demolished by earthquake. Afterward, Islam Kha rebuilt the fort in 1638. There was a palace, a court and a mint (takshal) inside the fort where the maximum important public services were carried out. Around 1702, a market named 'Padshahi Bazaar' (presently Chawk bazaar) was built on the south corner of the fort by Nawab Murshid Kuli Khan. The city expanded around the 'Padshahi Bazaar' and some connecting roads were built around the market and 'Bokshi bazaar', 'Dewan bazaar', 'Pilkhana', 'Mahut-tuli' areas and people started to live and work in those areas. The central business district (CBD) was formed around the 'Chawk bazaar' and the Jail area was known as Badshahi Fort.

In 1757, after the Battle of Plessey, Company rule was established in this subcontinent. In 1765, East India Company Headquarter was established in this Jail area. However, Dhaka Jail was established in colonial period by the British government at the place of Old Mughal fort in 1800. In 1879, Dhaka Jail transformed to DHAKA CENTRAL JAIL. Afterwards, in 2016, Central Jail was transferred from Old Mughal Fort area to Keraniganj.

5.2. SOCIO-POLITICAL SIGNIFICANCE OF CENTRAL JAIL

According to Michel Foucault in his book, *Discipline and Punish: The Birth of the Prison* said, "Prison is one part of a vast network, including schools, military institutions, hospitals, and factories, which build a panoptic society for its members. This system creates "disciplinary careers" for those locked within its corridors. It is operated under the scientific authority of medicine, psychology, and criminology." The social significance of Dhaka Central Jail includes-

- The Central Jail was not built as a penitentiary with original master planning. It was the effect of colonial reuse planning which turned a fort into a prison. Setting on a historic footprint, it holds the glorious evidence of Afgans, Mughals and Colonial rulings in Capital Dhaka.
- 'Boro Katra', 'Choto Katra', 'Shahi Mosque', 'Chawk bazaar' and other adjacent historic sites were built focusing on the placement of this fort. So, during the period of its peak, this fort area hold immense social impact on early flourishing of the city.
- The location of Dhaka Central Jail is this densely populated socially and commercially vibrated area is inappropriate for both the locality and the prison authority. Though the confined environment inside the prison is not the part of the locality but the peripheral wall has made a dialogue with its immediate surroundings. Dwellers of the localities want the land free from prison but don't want the high wall vanish overnight as it is very familiar to them rather than the unknown world inside it.

Jail, serving as prison or correctional facilities, broadly houses the convicted criminals or under trial individuals. Jail is a repressive weapon of the ruling authorities to hold individuals for imposing political control and appeasement. The political significance of central jail includes-

- The Central Jail on Nazimuddin Road witnessed many historical and political episodes. The facility housed many political prisoners, especially during the Language Movement of 1952, the Six-Point Movement and the Liberation War of 1971. In 1948, along with Sheikh Mujibur Rahman, some other leaders were held at Central Jail that invoked people to burst out against the ruling party. In 1966, Sheikh Mujib was again prisoned for Six-Point Movement that intrigued a mass involvement across the country. A huge crowd was gathered outside the jail area in the Mass Movement of 1969 to free Sheikh Mujib from the Central Jail.
- Former Vice-President Syed Nazrul Islam, former Prime Minister of Bangladesh Tajuddin Ahmed, Captain (Rtd.) Mansur Ali, and former Home Minister A H M Quamruzzaman, these four heroic

national leaders were killed on 3rd November in 1975 inside the Jail premises. It is observed as Jail Killing Day each year.

- In recent years, War Criminals are prisoned at the Central Jail and a few of them are sentenced to death and hanged till death in the Jail premises. Among them Abdul Quader Mollah, Muhammad Kama-ruzzaman, Ali Ahsan Mojaheed, Salahuddin Quader Chowdhury, Motiur Rahman Nizami, Mir Quasem Ali are noteworthy. The whole movement was largely supported by the mass people nationwide and a platform called 'Gonojagonor Moncho' was formed claiming justice against the liberation war crimes.

5.3. TIMELINE OF OLD DHAKA: HISTORY AND CONTEXT

The Old Dhaka has its legacy for more than 400 years old which proves the significant history and context of Dhaka. The Pre-Mughal settlement was bound by the canal and river and Pathan and Afgan were settled here. In 1610, Islam Khan declared Dhaka as capital of Bangla and that was a revolutionary incident for Dhaka. Mughal Dhaka was much developed and many forts were established in that time frame like 'Choto Katra', 'Boro Katra', 'Lalbagh' etc. In 17th century the European traders came in large numbers to establish factories and thus Dhaka became the center of trade and commerce. Dhaka was most important for Mughal naval headquarters and it was abolished in 1769. From 1801 to 1840 the locality close to the city were largely abandoned. In colonial period, after taking over in 1757 the East India Company was granted the power of revenue collection and they shifted the power to Calcutta in 1772. In Pakistani period from 1947-71, Dhaka was the second capital of Pakistan. Some development work was done and it expanded as a city but it was also a place of oppression due to political issues. Now the Old Dhaka has become a national heritage for its rich cultural and historical value. It has become an enrich capital which has its history of more than 400 years old.

5.4. HERITAGE SITE MANAGEMENT: ACTS, ATTRIBUTES AND AMENITIES

The National Heritage site selection criteria states that- the heritage site should be minimum 100 years old and the heritage site should have outstanding historical and contextual significance. Some important articles for heritage management in Bangladesh includes-

- *The Constitution of Peoples' Republic of Bangladesh* (Art. 23&24) which specifies that the State shall adopt measures for the protection against disfigurement, damage or removal of all monuments, objects or places of special artistic importance or interest.
- *The Antiquity Act of 1968* (Art. 16) states that if immovable antiquity is in danger of being destroyed, it would be under Land Acquisition Act 1894 as for a public place.
- *Dhaka Imarot Nirman Bidhimala 2008* (Chapter 7, topic 61) suggests that for the conservation and preservation of historically important buildings and sites, any development activity within 250m radius from periphery of the enlisted building or preserved area or Detail Area Plan (DAP) indicated specially selected area should be carried out by the rules set for the historic preservation of that area.

5.5. REINTEGRATION AS AN ART OF PLACE MAKING THROUGH CASE STUDIES

Depending on the need of the community different types of reintegration is seen all over the world starting from residence to housing, school to park, museum to concert hall etc. Laurel Hill, Virginia was formerly a prison named Lorton Reformatory which is located in a sub-urban area and potentially reintegrated as a mix-used development to the surrounding neighbourhood. Another great example is Bangalore's Freedom Park where a Prison is reintegrated into a place of celebrating freedom, free thought and citizen's right as much as it gave the city a public space like never before. Most of how the Freedom park stand today retains the original ideas but celebrating history while redefining spaces to meet the contemporary needs. Furthermore, a British colonial prison in Lagos was demolished in the civil war of Nigeria where some of their national heroes died. The new reintegration planning is done remembering the past making reference to the positioning of the old buildings and thus a place of sorrow is transformed into a place of happiness.

6. Contextual Analysis

6.1. CHANGING PATTERNS OF THE SURROUNDING LAND USES AND TRAFFIC AND TRANSPORTATION

'Central Jail' and its surroundings established a long time ago and carries a lot of memories to its people and existing structure. In 1971, most of the building were burnt down and after Liberation War most

of the buildings were reconstructed along Nazimuddin road, Urdu road, Chawk Bazaar road and Central Jail road. In recent years, most of residential buildings along the road have been transformed into mixed used buildings using ground floor as general stores. Variation of skyline is decreasing rapidly due to the incremental rise of building height alongside the road.

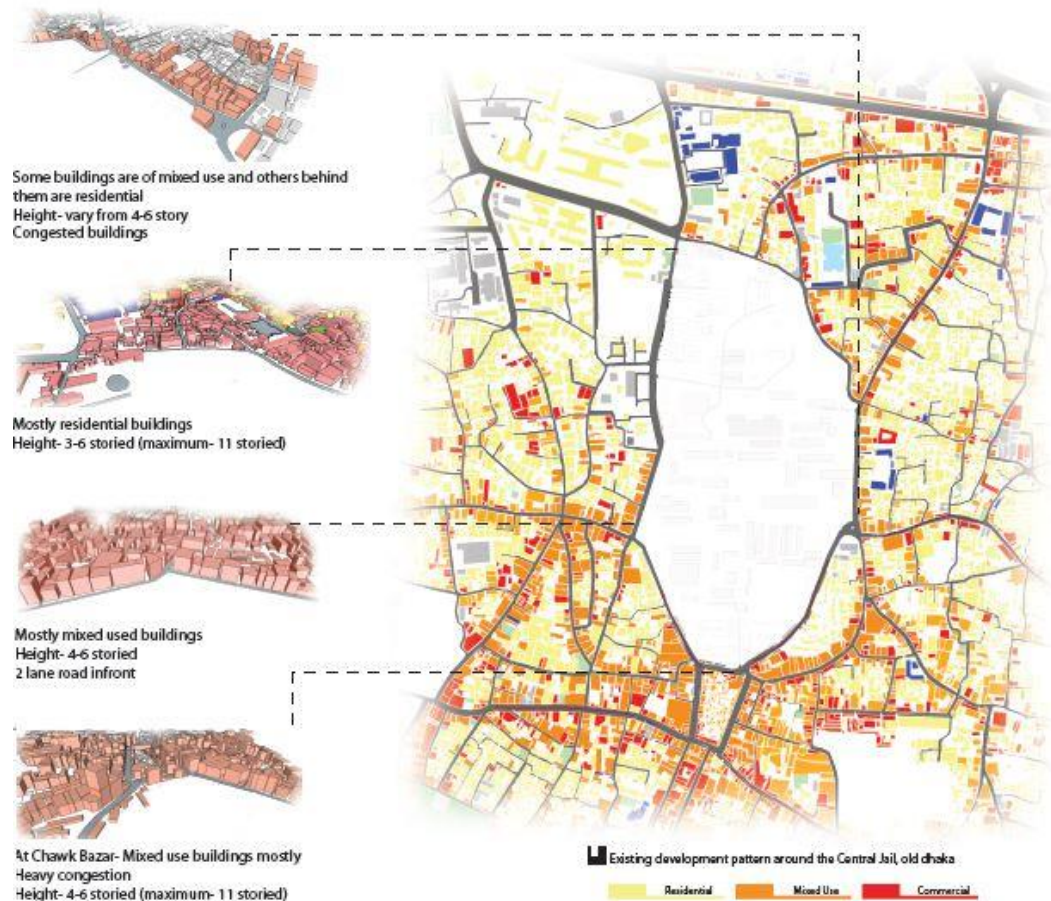

Figure 1. Existing development pattern around central jail (Source: Author)

Pedestrian, horse and elephant driven cart were the initial media of transportation in Old Dhaka. The roads along the fort area was developed organically which is now quite insufficient to meet up the present traffic load. One of the primary roads around old Jail site was Nazimuddin road which is 29 ft wide road on the eastern side of the project area is an important primary road which connects the project area to new Dhaka. Jail road, while encompassing the Central Jail area connects 25ft. wide Abul Hasnat road on the eastern side and serve the Bangshal area. The Jail road connects Urdu road which is 24 ft wide from the west and serves Chawk Bazaar area in the south and Palashi area in the west. The other access to this area is by Bakshibazar road, which is 25 ft wide.

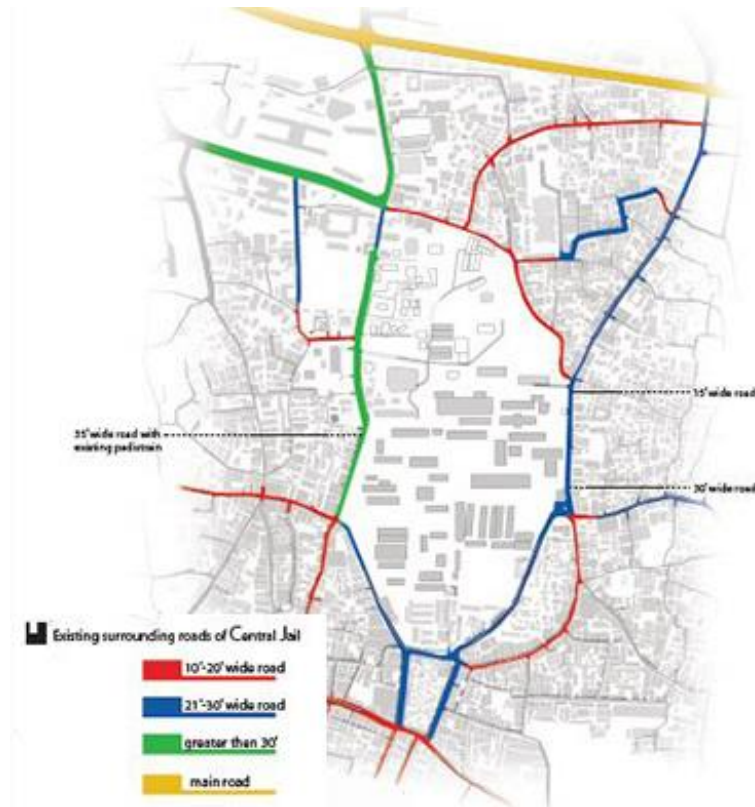

Figure 2. Width of existing roads surrounding the Jail area (Source: Author)

6.2. SURROUNDING PUBLIC PLACES AND NODAL CONDITIONS

Central Jail is connected to Lalbagh fort through Urdu road on the western side. Curzon hall, Hossaini Dalan is located on the northern side of Jail area and Shahi Mosque, Chawk Bazaar, Boro Katra, Choto Katra, Ahsan Manjil is located on the southern side. Heavy traffic congestion and over pedestrian flow is observed in Nazimuddin road and Chawk bazaar area. The nodes are overcrowded and under the illegal encroachment of street hawkers.

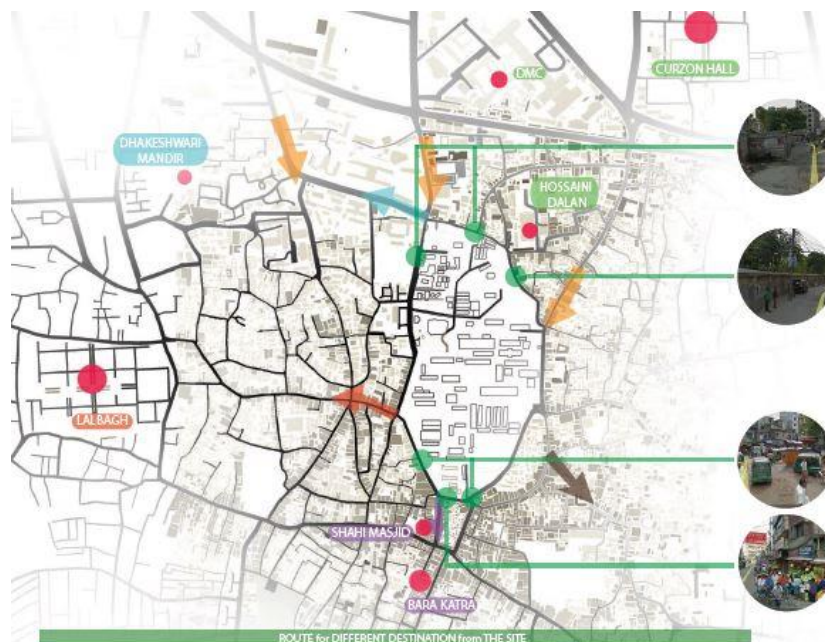

Figure 3. Routes and different destination from the site (Source: Author)

6.3. OLD DHAKA DEVELOPMENT AND DEVELOPMENT CONTROL MECHANISM

The Development in Dhaka has not been consistent through centuries. From Mughal planning in 17th century to DAP of 21st century, numerous development planning projects have been undertaken. Development of Dhaka has been evaluated according to these planning projects. Furthermore, Old Dhaka has a lot of heritage sites within, which are being destroyed due to lack of maintenance and consciousness. The control of development of Old Dhaka as a heritage site has been mentioned in various acts and rules.

- 1917: Dacca Town Planning Report
- 1948: East Pakistan Planning Sub-Committee
- 1959: Dhaka Master Plan
- 1981: Dhaka Metropolitan Area Integrated Urban Development Project
- 1995 : Dhaka Metropolitan Development Plan (DMDP)

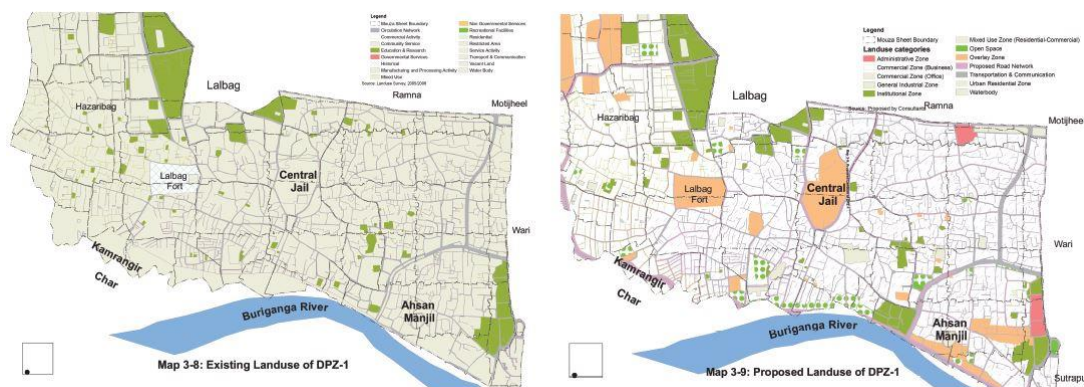

Figure 4. Existing and proposed land use in DMDP (Source: DAP)

6.4. LOCAL USERS DEMANDS: NEEDS FOR OPEN SPACES

Taking nearby six wards (30,31,32,33,34,35,36) into count five major open fields are identified including- Bangladesh filed (area 43,777sq ft) along Aga Sadek road, Sabistan Field (area 68,868 sq ft) along Armanitola road, Armanitola Playfield (area 34,353 sq ft), Rahmatganj Playfield (area 96,137 sq ft) and Bakshi bazaar playground (area 54,334 sq ft). The total open area is 6.82 acre and the population as per BBS census 2012 is 210006 persons estimating .0325 acre open area per 1000 people. Considering Jai area as open space the total open space can rise to 45.82 acres and the ration would be .218 acre open area per 1000 people.

7. Conclusion

Old Dhaka was developed as the centre of city during the Mughal period. It has been the heart of Dhaka until the contemporary Dhaka developed. It developed through densification, rather than physical expansion. The existence of historic structures like, Ahsan Manjil, Lalbagh, Bara Katra, Choto Katra etc. have made the whole city as a heritage site. Unfortunately, the historic structures are on the verge of ruin due to lack of maintenance, which if preserved could be developed as tourist spot.

Though there are rules and regulations about development control in the city and heritage site management policies, these are hardly followed in the practical field. So the scopes and opportunities of reintegrating Central Jail in the Old Dhaka within the formulated rules and acts are discussed as to control the uncontrolled and irregular growth.

8. Acknowledgment

This paper was developed as a Studio Project of B.Arch program of Bangladesh University of Engineering and Technology, Studio project (Level 4 Term 1): *Reintegrating Central Jail: Appropriating Old Dhaka in Place Making*. Studio Teachers: Prof. Dr. Shayer Ghafur, Dr. Catherine D Gomes, Faruk Ahmed and Md. Tariquzzaman. Group Members: Hasan Muntasir,

Ehsanul Haque and study report done by all the members of Batch 2011, Department of Architecture, Bangladesh University of Engineering & Technology, Dhaka, Bangladesh.

9. References

- Larkham, P. J. *Conservation and the City*. Routledge, London, 1996
- Ahmed, S. U. *Dacca: A Study in Urban History and Development*. Dhaka: Curzon Press.1986.
- Foucault, M. *Discipline and Punish: The Birth of the Prison*. Pantheon Books, 1977
- Ahmed, S. U. *Dhaka-Past Present Future*. The Asiatic Society of Bangladesh
- *400 Years of Capital Dhaka and Beyond - Environment of Capital Dhaka*, The Asiatic Society of Bangladesh
- Hossain, N. *Kingbodintir Dhaka* , Nowroz Kitabistan
- Mamun, M. *Dhaka Somogro*, Annanya Publishers
- Taifoor, S.M. *Glimpses of Old Dhaka*. Dhaka: Pioneer, 1956
- *Dhaka Imarot Nirmal Bidhimala:2008*
- *Wikipedia*

Samarawickrama, Sumanthri, et al (eds), 2018, "Sustainability for people - envisaging multi disciplinary solution": *Proceedings of the 11th International Conference of Faculty of Architecture Research Unit (FARU), University of Moratuwa, Sri Lanka, December 08, 2018 Galle* pp. 212–219. ©

SUSTAINABLE WATER MANAGEMENT IN IRRIGATION SYSTEMS

SIRIMEWAN. D.C.¹, MANJULA. N.H.C.²

Department of Building Economics, University of Moratuwa, Sri Lanka

¹dianisirimewan@gmail.com, ²chathurigm@gmail.com

Abstract

The increasing demand for water, coupled with its scarcity, has become an unceasing issue worldwide. Therefore, Sustainable Water Management (SWM) has become a major challenge in the 21st century. Irrigation systems are consuming around 60-70% of water around the globe, and thus play a critical role in water sustainability. This paper therefore aimed to investigate the issues due to poor Irrigation Water Management (IWM) practices, and the concept of Integrated Water Resources Management (IWRM) as a tool for SWM in irrigation systems.

Research have identified issues in IWM under four main categories, namely, issues in: efficiency of the system; equity of water distribution; economic acceptability; and environmental integrity. The major issues, which affect to the efficiency of the irrigation systems, were water losses in conveyance channels and field applications. Issues in water allocation lead to inequity of water distribution among the water users. Waterlogging, salinization and ground water depletion are the major issues caused by poor IWM practices. Further, failure to achieve the expected performance over the investment is a threat to the economic acceptability of irrigation systems.

SWM evaluation models are useful in decision making regarding the issues associated with three dimensions of sustainability from local to global level, both in short-term and long term perspectives. IWRM can be identified as an enabling tool in SWM, which can be used in managing water resources as a whole. This paper proposes a conceptual model to address issues in SWM in irrigation sector using IWRM, which can be applied to Sri Lankan irrigation sector to ensure sustainable and economical water management strategies.

Keywords: *Sustainable Water Management, Irrigation Systems, Irrigation Water Management, Integrated Water Resource Management*

1. Introduction

Sustainable Development (SD) is a popular concept in various industries including the construction industry. It is a guiding principle for fair and equitable sharing of benefits and costs associated with environmental integrity and economic development (Hansmann, Mieg, and Frischknecht, 2012). The SWM is linked with the SD, as it requires the trade-off among the environmental, economic and social aspects, while allocating water for competing needs.

The total annual water consumption of irrigation systems worldwide was reported to be around 60%-70% (Liu et al, 2017). Thus, it has to play a critical role in the sustainable use of water. However, the inefficient and uneconomical use of irrigation water, and the poor performance of irrigation infrastructures are affecting to the SWM of irrigation systems (Buyukcangaz and Korukcu, 2007). The environmental issues associated with the development and management of irrigation systems, led to a debate on the impacts of them to the environment. Therefore, the study aims to investigate

- The issues of Irrigation Water Management (IWM)
- Solutions to mitigate them to achieve SWM of irrigation systems
- SWM evaluation models used in evaluating the sustainable performance of water management
- Suitability of IWRM as an integrated assessment tool for strategic planning and management of water resources.

- Propose a conceptual model for SWM in irrigation systems through IWRM

2. Sustainable Water Management

The sustainability concept has been evolving over centuries. It is an integrative concept (Gibson, 2006) with the intersection of environmental, economic and social aspects, which are considered as the fundamental dimensions of sustainability (Hansmann, Mieg, and Frischknecht, 2012). According to the definition proposed by the Brundtland Report, to achieve the sustainability, there should be a development, which meet the current needs without interrupting to the right of future generations to meet their own needs. (WCED, 1987). However, different views and the various arguments on the concepts of sustainability and the SD were coming after the publication of the Brundtland Report (Moldan, Janouskova, and Hak, 2012; Hak, Janouskova, Moldan, and Dahl, 2018). Some researchers argue that SD is a process of achieving sustainability (Moldan et al, 2012), while others maintain that it only concerns the economic development (Moltesen and Bjorn, 2018). However, it can be concluded that the SD should be well-defined to address the fundamental dimensions of sustainability, to achieve economic development with minimum impact to the environment, while ensuring the social well-being.

The SWM is a decisive part of SD, as it requires managing water by balancing the social welfare, environmental integrity and economic efficiency (Melloul and Collin, 2003). Sun et al (2016) highlighted the importance of maintaining the environmental stability through SWM practices for supporting the social and economic development of a country. The Food and Agricultural Organisation (FAO) in 2012, reported the irrigation sector as the largest commercial consumer of water, which accounts for about 70% of water withdrawal in the global context. Therefore, strategic improvements regarding institutional, managerial and technical aspects are essential to achieve SWM in irrigation systems (Gutierrez, Villa-Medina, Nieto-Garibay, and Porta-Gandara, 2014). SWM in irrigation sector can be hindered by various issues of IWM. According to previous research (Ahmad, 1999; Cai, McKinney, and Rosegrant, 2003; Buyukcangaz and Korukcu, 2007), the issues in IWM fall into four main categories, namely, issues towards the efficiency of the system, equity of water distribution, environmental integrity and economic acceptability of irrigation systems. The succeeding section focuses on issues of IWM and the possible causes.

2.1. ISSUES IN IWM

The efficiency of the system can be used to measure the performance of irrigation infrastructures including water retaining structures, water conveyance channels and water distribution channels, and the water use efficiency of field applications (Pereira et al, 2002). As indicated by Marsden Jacob Associates (2003), the difference between the quantity of water issued from the water storage and the amount received to the distribution channels indicate the efficiency of water conveyance. The equity denotes the equal distribution of water among the water users as per their requirements. Cai et al (2003) broadly described the term equity in SWM as the water use rights of the people, including costs and benefits of the water consumption, without impairing the needs of them. Therefore, the water shall be delivered with sufficient quantity and quality, at the right time, up to the tail-end water users in the system (Shilling, Khan, Juricich, and Fong, 2013).

Singh (2016) pointed out that the inefficient practices of irrigation and poor planning and management of the system led to environmental degradation. Therefore, improvement in the IWM is a primary objective of SWM to protect the environment and the eco-system to ensure the environmental integrity. The efficiency of irrigation systems directly effects to the economic acceptability of its investment. Greenland (2017), identified the lack of investment in adopting new practices of IWM is a major barrier to get the benefits of sustainable use of water.

Research have identified various issues arising from non-attention to these categories. Accordingly, *Table 1* summarizes the issues of IWM identified under the aforementioned categories with causes for those issues.

Table 16: Common issues towards sustainable IWM

	Identified Issue	Causes of the issue	Reference
Efficiency	Water losses in canals	✓ Seepage losses	Khan et al (2006)
	Water losses in field applications	✓ Non-uniformity of water application due to improper designing and management of sprinkler systems	Poddar et al (2014)
Equity	The inequity of water allocation	✓ Resource allocation based on the equity goal	Zaman et al (2017)
Environmental Integrity	Waterlogging and Salinization	✓ Seepage losses ✓ Percolation of irrigated fields ✓ Inadequate drainage ✓ Over-exploitation of ground water	Donaldson (2013)
	Depletion of ground water	✓ Demand for water supply through pumping exceeds the water supply through recharge from irrigation	Pereira et al (2002)
	Water pollution (Reduce water quality)	✓ High levels of fertilizers and agrochemical use ✓ Deep percolation of water	Howell (2006)
Economic Acceptability	The inequity of income distribution compared to the cost incurred	✓ Fails to earn benefits in the long-term over the initial financial outlay	Cai et al (2003)

2.2. SOLUTIONS TO MITIGATE THE ISSUES IN IWM

Solutions to mitigate the issues of IWM, identified under the four main categories (refer Table 1) are briefly described below.

2.2.1 Efficiency

Concrete lining was identified by Akkuzu, Unal, and Karatas (2007) as the solution for water losses due to seepage in water conveyance channels. Further to the authors, it shall be consist with new concrete mixtures and more economical, durable and long lasting methods, which can withstand the effects of water and soil. Further, the authors revealed that the awareness of the users regarding proper practices, when they are taking water from channels would minimise the water losses in conveyance. Hamdy, Ragab, and Scarascia-Mugnozza (2003) recognised the poor designing and management of sprinkler irrigation led to huge wastage of water in the fields. Thus, they suggested efficient water application techniques such as overhead irrigation and micro irrigation with proper operation and management practices to reduce water losses in the fields.

2.2.2 Equity

According to Evans et al (2003), land-based water allocation and irrigation-based water allocation can be proposed as solutions for the problem of inequity of water resource allocation. Further to the author, in a land based water allocation, an equal amount of water is allocated per hectare of land throughout the watershed and the water is proportionately allocated per hectare according to the requirement of

irrigation in irrigation-based water allocation. Therefore, depending on the equity goal, the water allocation has to be done in a fair and equitable manner.

2.2.3 Environmental Integrity

Waterlogging, salinization and ground water depletion were recognised as the major issues towards the environmental integrity due to poor IWM practices. Singh (2016) proposed to install bio-drainage system as a cost effective solution to reduce waterlogging due to inadequate and improper drainage systems. Further to the author, reducing water losses in channel system through lining the channels would avoid the seepage losses and minimise the deep percolation into the ground. Furthermore, Scanlon et al (2012) indicated increasing the use of surface water by improving the efficiency of irrigation techniques and expanding the capacity of existing irrigation infrastructures would reduce the ground water depletion in irrigated areas. The author mentioned that by raising the elevation of dams, the existing capacity of water storages can be increased. Hence, it would be able to retain more quantity of water. Additionally, the quality of water would reduce due to the excessive use of fertilizers in fields and high deep percolation of water into the ground. Thus, A. Zaman, Zaman, and Maitra, (2017) proposed to adapt water disinfection techniques by means of physical, chemical or other alternative method to avoid the water pollution.

2.2.4 Economic Acceptability

The failure in achieving the expected benefits of irrigation infrastructures over the initial financial outlay is a threat to the economic acceptability of the system. The inefficiency of the structures due to water losses throughout the system is the major reason for such failure. Therefore, it is apparent that improved irrigation management would be a solution in this regard. Further, Evans et al (2003) highlighted the economic efficiency-based water allocation, which refers to allocating water for the uses that brings the highest return to ensure economic acceptability.

Literature has discussed various SWM evaluation models, those could be useful in sustainable management of irrigation water. The next section focuses on such models.

2.3. SWM EVALUATION MODELS

Manageable indicators, which are based on well-defined guidelines and principles for evaluating the sustainability, are important to the decision makers to identify the problems, provide early warnings, and to take necessary actions in organizational management (Singh, 2009). Most of the organisations have recognised the need of sustainable evaluation models or tools to clarify how, and to what extent the current activities of the organisation are unsustainable (Singh, 2016). According to Kates et al (2001), sustainability assessments evaluate the integrated nature of the three dimensions from local to global level in both short term and long-term perspectives. Further to the authors, the results would help decision-makers to determine what should or should not be attempted social sustainability.

Evaluation of sustainable use of the water in irrigation systems is important to reduce water losses and enhance the efficient water usage through improved irrigation management (Lou, Cui, and Yang, 2014). Ness, Urbel-Piirsalu, Anderberg, and Olsson (2007), categorised the valuation models into three main sections, namely, Indicators and Indices, Product Related Assessments and Integrated Assessments. According to Russo, Alfredo, and Fisher (2014), the indicators provide simple numerical results, which can be compared in assessing the capabilities of the cases. Further, Life Cycle Assessments (LCAs) and Life Cycle Costs (LCCs) approaches can be identified as product related assessments. The LCAs provide information about the physical system or supply chain regarding land, water and energy requirements (Russo et al, 2014), whereas the LCCs is dealing with general as well as the environmental cost of various alternatives (Hardin and Baumann, 2004). According to Ness et al (2007), the integrated assessments are supported in the decision making process related to policies or a project in a specific area. Further to the authors, project specific models are used for local assessments, while policy related models are focusing on local to global scale assessments. *Table 2* signifies examples for SWM evaluation models.

Table 2: SWM evaluation models

Category	Examples of Models	Source
Indicators & Indices	Water Poverty Index (WPI)	Lawrence, Meigh, and Sullivan (2002)
	Environmental Performance Index	Yale (2018)
	Watershed Sustainability Index (WSI)	Chaves and Alipaz (2007)
Product Related Assessment (LCA/LCC)	Water Footprint	Hoekstra, Chapagain, Aldaya, and Mekonnen (2011)
	Ecological Footprint	Ewing, Reed, Galli, Kitzes, and Wackernagel (2010)
Integrated Assessment	Conceptual modelling	Singh (2009)
	Cost Benefit Analysis (CBA)	Pereira et al (2002)
	Risk and Uncertainty Analysis	Ness et al (2007)
	Impact Assessments (i.e., EIA)	Lee and Kirkpatrick, (2006)

In the context of sustainability assessments, Integrated Assessment (IA) tools are often focused on the foresight and carried out in the cases having the scenario nature (Ness et al, 2007). Further to the authors, many of these IA tools are based on system analysis methods and integrated natural and social aspects. The IA tools are providing more powerful quantifications than the indicator or indices method alone (Russo et al, 2014). Ness et al (2007) identified the conceptual modelling as an IA tool, which can be used to analyse qualitative relationships for visualising and detecting problems, where changes in a given system lead to achieve sustainability.

2.3.1 Integrated Water Resource Management

Integrated Water Resources Management (IWRM) is a process of managing water resources as a whole in a sustainable and consistent manner as recognized by Buyukcangaz and Korukcu (2007). Further to the authors, it provides a practical guide to the management authorities to respond the challenges of SD in the water sector. It highlights the stakeholder management, real time communication and collaboration throughout the system. Therefore, this can be used for decision making by implementing different strategies to address specific SWM issues in various levels of the system. The process of IWRM is depicted in Figure 1.

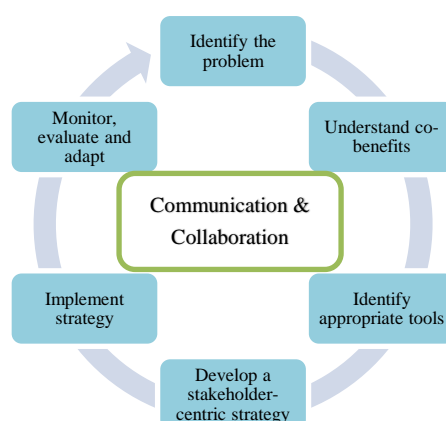

Figure 24: The process of IWRM

(Source: Integrated Water Resource Management Center, 2017)

Ness et al (2007) highlighted that the integrated systems shall address multi-disciplinary nature of environmental, social, technical, economical and legal concerns with long-term and short-term decision making. As shown in Figure 1, IWRM process requires the communication and collaboration of each party throughout the process. Accordingly, the water use can be quantified in terms of the losses,

unequal distribution, conservation of the natural eco - system and economic efficiency of the system. Therefore, the IWRM approach would interpret the broad guidelines of SWM into understandable means of IWM regarding operational and maintenance aspects. Therefore, this can be identified as an approach for treating the competing water needs in a fair, efficient and sustainable manner, and as a conceptual solution for water management issues.

2.4. CONCEPTUAL MODEL

A conceptual model is developed as shown in Figure 2, based on the issues identified under four main categories as listed in Table 1. In this model the concept of IWRM is used as a tool for decision making in order to attain the SWM in irrigation systems. Based on this model the strategies to overcome the issues and enhance the sustainability performance of IWM through the process of IWRM can be identified.

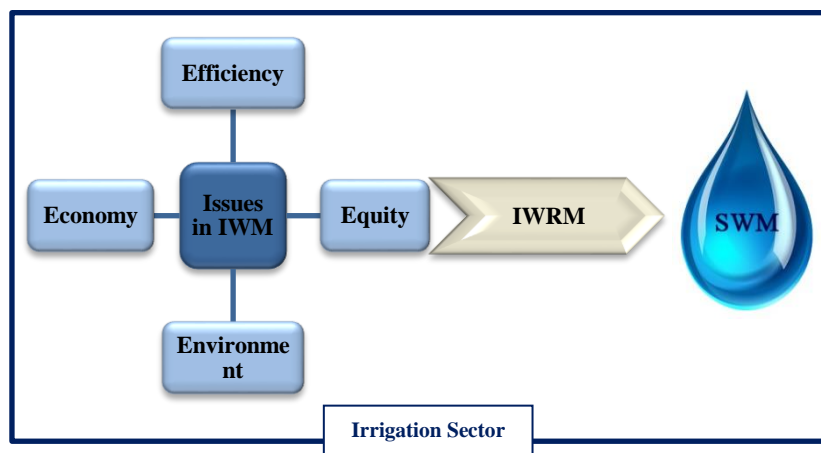

Figure 25: Conceptual model to understand SWM through IWRM

3. Conclusions

This paper presented the findings on sustainable water management of irrigation systems. A thorough literature review was undertaken to investigate the associated issues of irrigation water management and their impact on sustainability. The paper categorized the issues of IWM under four categories, namely, efficiency; equity; environment and economy. Findings suggest that water losses throughout the system, most importantly in water conveyance channels and field applications, reduce the efficiency of the irrigation system. Therefore, canal lining with durable materials would be most economical solution to avoid water losses in conveyance. The use of efficient practices of irrigation such as overhead and micro-irrigation with proper designing and operation would reduce the water wastage at the field level. Moreover, the land-based and irrigation-based water allocation as per the requirement has been identified to protect the water sharing rights of the users.

Poor irrigation practices impacted the environmental integrity in different ways. Waterlogging, salinization and ground water depletion were the main issues towards the ecological stability. The findings revealed that installing bio-drainage systems as a cost-effective solution to reduce waterlogging and salinization in irrigated areas. Further, by increasing surface water supply through expanding the current capacity of water storages could minimise the ground water depletion. The inefficiency and poor performance of infrastructures over the investment in development and maintenance of them were affected the economic acceptability of irrigation systems. Hence, water allocation for the uses, which brings higher return would be reduce the opportunity cost of misallocation of water.

SWM evaluation models are necessary for decision makers at various levels of authorities. Mainly there are three types of models, namely, indices and indicators, product related assessments and integrated assessments. IWRM was identified as an integrated approach for managing the competing water needs in a sustainable manner, and a conceptual model was proposed to use IWRM for SWM in irrigation systems.

References

- Ahmad, S. 1999. Achievements and issues of irrigation in the 20th century. In *Proceedings of the National Workshop on "Water Resources Achievements and Issues in the 20th Century and Challenge of the Next Millennium"* [online], 28-30. Available from: http://scholar.googleusercontent.com/scholar?q=cache:jT5VcU3Ex8oJ:scholar.google.com/+Achievements+and+issues+of+irrigation+in+the+20th+century&hl=en&andas_sdt=0,5
- Akkuzu, E., Unal, H. B., and Karatas, B. S. 2007. Determination of water conveyance loss in the Menemen open canal irrigation network. *Turkish Journal of Agriculture and Forestry* [online], 31(1), 11-22. Available from: <http://citeseerx.ist.psu.edu/viewdoc/download?doi=10.1.1.573.9766&rep=rep1&type=pdf>
- Buyukcangaz, H., and Korukcu, A. 2007. Integrated approach for water resources and irrigation management in Turkey. *Water International*, 32(sup1), 710-719.
- Cai, X., McKinney, D. C., and Rosegrant, M. W. 2003. Sustainability analysis for irrigation water management in the Aral Sea region. *Agricultural Systems*, 76(3), 1043-1066.
- Chaves, H. M., and Alipaz, S. 2007. An integrated indicator based on basin hydrology, environment, life, and policy: the watershed sustainability index. *Water Resources Management*, 21(5), 883-895.
- Donaldson, M. 2013. Rehabilitation and modernisation of irrigation schemes. *Proceedings of the Institution of Civil Engineers - Water Management*, 166(5), 242-253.
- Evans, E. M., Lee, D. R., Boisvert, R. N., Arce, B., Steenhuis, T. S., Prano, M., and Poats, S. V. 2003. Achieving efficiency and equity in irrigation management: An optimization model of the El Angel watershed, Carchi, Ecuador. *Agricultural Systems*, 77(1), 1-22.
- Ewing, B., Reed, A., Galli, A., Kitzes, J., and Wackernagel, M. 2010. *Calculation Methodology for the National Footprint Accounts* [online]. Available from: http://www.footprintnetwork.org/content/images/uploads/National_Footprint_Accounts_Method_Paper_2010.pdf
- Gibson, R. B. 2006. Beyond the pillars: Sustainability assessment as a framework for effective integration of social, economic and ecological considerations in significant decision-making. *Journal of Environmental Assessment Policy and Management*, 8(3), 259-280.
- Greenland, S. J., Dalrymple, J., Levin, E., and O'Mahony, B. 2017. Improving agricultural water sustainability: Strategies for effective farm water management and encouraging the uptake of drip irrigation. *The Goals of Sustainable Development*, 111-123.
- Gutierrez, J., Villa-Medina, J. F., Nieto-Garibay, A., and Porta-Gandara, M. A. 2014. Automated irrigation system using a wireless sensor network and GPRS module. *IEEE Transactions on Instrumentation and Measurement*, 63(1), 166-176.
- Hak, T., Janouskova, S., Moldan, B., and Dahl, A. 2018. Closing the sustainability gap: 30 years after "Our Common Future", society lacks meaningful stories and relevant indicators to make the right decisions and build public support. *Ecological Indicators*, 87, 193-195.
- Hamdy, A., Ragab, R., and Scarascia-Mugnozza, E. 2003. Coping with water scarcity: Water saving and increasing water productivity. *Irrigation and Drainage*, 52(1), 3-20.
- Hansmann, R., Mieg, H. A., and Frischknecht, P. 2012. Principal sustainability components: Empirical analysis of synergies between the three pillars of sustainability. *International Journal of Sustainable Development and World Ecology*, 19(5), 451-459.
- Hardin, G. 1968. The tragedy of the commons. *Science*. 168(3859), 1243-1248.
- Hoekstra, A. Y., Chapagain, A. K., Aldaya, M. M., and Mekonnen, M. M. 2011. *The Water Footprint Assessment Manual* [online]. Available from: http://waterfootprint.org/media/downloads/TheWaterFootprintAssessmentManual_2.pdf
- Horrihan, L., Lawrence, R. S., and Walker, P. 2002. How sustainable agriculture can address the environmental and human health harms of industrial agriculture. *Environmental Health Perspectives*, 110(5), 445-456.
- Howell, T. 2006. *Challenges in increasing water use efficiency in irrigated agriculture* [online]. Available from https://www.researchgate.net/publication/228360952_Challenges_in_increasing_water_use_efficiency_in_irrigated_agriculture
- Integrated Water Management Resource Centre. 2017. *Introducing integrated water management* [online]. Available from: <https://www.americanrivers.org/conservation-resources/integrated-water-management/>
- Kates, R., et al. 2001. Sustainability Science. *Science*, 292(5517), 641-642.
- Khan, S., Tariq, R., Yuanlai, C., and Blackwell, J. 2006. Can irrigation be sustainable? *Agricultural Water Management*, 80(1-3), 87-99.
- Lee, N., and Kirkpatrick, C. 2006. Evidence-based policy-making in Europe: An evaluation of European Commission integrated impact assessments. *Impact Assessment and Project Appraisal*, 24(1), 23-33.
- Liu, J. H., Hertel, T. W., Lammers, R. B., Prusevich, A., Baldos, U. L., Grogan, D. S., and Frolicking, S. 2017. Achieving sustainable irrigation water withdrawals: Global impacts on food security and land use. *Environmental Research Letters*, 12(10), 104009.
- Lou, Y. H., Cui, N. B., and Yang, H. X. 2014. Establishment and application of a comprehensive evaluation model for management of water-saving irrigation developing level based on set pair analysis - Si Chuan province as example. *Applied Mechanics and Materials*, 522, 1027-1033.

- Marsden Jacob Associates. 2003. *Improving water-use efficiency in irrigation conveyance systems: A study of investment strategies* [online]. Available from: <http://www.insidecotton.com/xmlui/bitstream/handle/1/1756/pro30516.pdf?sequence=2&disAllowed=y>
- Melloul, A. J., and Collin, M. L. 2003. Harmonizing water management and social needs: a necessary condition for sustainable development: The case of Israel's coastal aquifer. *Journal of Environmental Management*, 67(4), 385-394.
- Moldan, B., Janouskova, S., and Hak, T. 2012. How to understand and measure environmental sustainability: Indicators and targets. *Ecological Indicators*, 17, 4-13.
- Moltesen A., and Bjorn A. 2018. LCA and Sustainability. In: M. Hauschild M., R. Rosenbaum., and S. Olsen. ed. *Life Cycle Assessment*. Available from: SpringerLink database. 43-55.
- Ness, B., Urbel-Piirsalu, E., Anderberg, S., and Olsson, L. 2007. Categorising tools for sustainability assessment. *Ecological Economics*, 60(3), 498-508.
- Pereira, L. S., Oweis, T., and Zairi, A. 2002. Irrigation management under water scarcity. *Agricultural Water Management*, 57(3), 175-206.
- Poddar, R., Qureshi, M. E., and Shi, T. 2014. A comparison of water policies for sustainable irrigation management: The case of India and Australia. *Water Resources Management*, 28(4), 1079-1094.
- Russo, T., Alfredo, K., and Fisher, J. 2014. Sustainable Water Management in Urban, Agricultural, and Natural Systems. *Water*, 6(12), 3934-3956.
- Scanlon, B. R., Faunt, C. C., Longuevergne, L., Reedy, R. C., Alley, W. M., McGuire, V. L., and McMahon, P. B. 2012. Groundwater depletion and sustainability of irrigation in the US High Plains and Central Valley. In *Proceedings of the National Academy of Sciences*, 9320-9325.
- Shilling, F., Khan, A., Juricich, R., and Fong, V. 2013. Using Indicators to Measure Water Resources Sustainability in California. In *Proceedings of the World Environmental and Water Resources Congress 2013* [online], 2708-2715. Available from: <https://ascelibrary.org/doi/abs/10.1061/9780784412947.268>
- Singh, A. 2016. Hydrological problems of water resources in irrigated agriculture: A management perspective. *Journal of Hydrology*, 541, 1430-1440.
- Singh, R. K., Murty, H., Gupta, S., and Dikshit, A. 2009. An overview of sustainability assessment methodologies. *Ecological Indicators*, 9(2), 189-212.
- Sun, S., Wang, Y., Liu, J., Cai, H., Wu, P., Geng, Q., and Xu, L. 2016). Sustainability assessment of regional water sources under the DPSIR framework. *Journal of Hydrology*, 532, 140-148.
- World Commission on Environment and Development (WCED). 1987. *"Our common future": The Brundtland report* [online]. Available from: http://www.bne-portal.de/fileadmin/unesco/de/Downloads/Hintergrundmaterial_international/Brundtlandbericht.File.pdf?linklisted=2812
- Yale Center for Environmental Law and Policy. 2018. *Environmental Performance Index* [online]. Available from: <https://epi.envirocenter.yale.edu/>
- Zaman, A., Zaman, P., and Maitra, S. 2017. Water resource development and management for agricultural sustainability. *Journal of Applied and Advanced Research*, 2(2), 73.

Samarawickrama, Sumanthri, et al (eds), 2018, "Sustainability for people - envisaging multi disciplinary solution": *Proceedings of the 11th International Conference of Faculty of Architecture Research Unit (FARU), University of Moratuwa, Sri Lanka, December 08, 2018* Galle pp. 220–227. ©

EXPECTED IMPACT ON DESIGN DELIVERY RISK IN BIM BASED PROJECT IMPLEMENTATION IN SRI LANKA

DISSANAYAKE. A.G.N.D.¹, JAYASENA. H.S.², & WIJEWICKRAMA. M.K.C.S³

Department of Building Economics, University of Moratuwa, Katubedda, Sri Lanka

¹nayomidissaqs2013@gmail.com

Abstract

Building Information Modelling (BIM) is an innovative concept which has been using in the construction industry to increase the productivity by creating object based multi-dimensional parametric models. Though Sri Lankan construction industry is in the kindergarten stage of the BIM implementation, most of the developed countries are getting benefits through BIM. BIM can be adopted to the whole life cycle of the construction project not only for the specific phases. Construction industry is a place where it faces plenty of risks throughout its life cycle. Early stages of every project create more and more uncertainties because most of the decisions are made on early stages. Major construction risks were identified through extensive literature survey. Using that list, identified thirteen design delivery risks to carry out the research. Furthermore, carried out a questionnaire survey by using thirty-one respondents to identify the current design delivery risk rate in Sri Lankan construction industry. Semi structured interviews were carried out by using BIM experts to identified expected impact on design delivery risk after BIM implementation. At the end of the study conclusion is addressed to identify the expected impact on design delivery risk in BIM based project implementation in Sri Lanka.

Keywords: *Building Information Modelling (BIM); Design Delivery Risk; Sri Lanka.*

1. Introduction

The Building Information Modelling (BIM) is becoming a very precious topic nowadays because of its specialty. Most of the developed countries in the world tend to use BIM applications to achieve their goals and mainly government highly involves to create a better environment for implementing BIM. BIM can be identified as a new-fangled construction management process which is used as a tool to make object based multidimensional parametric models in the construction projects. Mainly construction sector does not have a simple process. It is a combination of lot of processes from the inception to end. Therefore, ultimate result is affected by each and every processes. Due to that reason BIM adoption for the whole process is not that much easy.

Construction industry is one of the most dynamic and challenging risky businesses. Basically, construction industry has a very poor reputation for managing risks. Hayes, Perry, and Thompson (1986) has viewed that most of the projects have failed to meet deadlines and cost targets. Hillson (2013) defines that risk as the uncertainty that can be measured and uncertainty is a risk that cannot be measured. Risk cannot be eliminated, but it can be minimised, transferred or retained (Burchett, Rao Tummala, & Leung, 1999). If risk is transferred, it should be transferred to the party who can bear it properly. Otherwise it will be affected to the final productivity, performance, quality and the final cost of the project. According to Hayes et al. (1986) risk is a part of all construction work in spite of the size of the project.

Risk Management is taken place where risk should be mitigated or eliminated. It is a system which focuses on recognising, quantifying, and managing all risks disclosed in a project (Flanagan & Norman, 1993). There are so many unsatisfactory consequences that can be arisen in different stages of the projects such as design, construction, and operation. For that situation risk management is a beneficial and proactive process to reduce likelihood of those unsatisfactory consequences (Mills, 2001; Rohaninejad & Bagherpour, 2013). In the construction projects, risk management is a logical systematic way of identifying, analysing and treating risk to achieve the project goals and objectives in proper manner. Risk management can be used as a tool for predicting future as well as making preferable decisions for better future (Smith, 1999). When implementing a process of a

project, there should be a proper risk management process which is able to deal with the risk. According to the Kululanga and Kuotcha (2010), comparatively low implementation of formal project risk management methods in practice directly affect to the performance of a project.

Especially in developing countries like Sri Lanka, there are rapid developments in construction sector during last decades. Due to that reason large scale of projects have become widespread, design theories are improving, new project delivery methodologies are being adopted and materials of construction are being found (Bryde, Broquets, & Volm, 2013). All of these things are generated as a result of risk. In response to these problems a new trend is taken place which is called BIM.

In the last few years, BIM has been playing a major role in AEC (Architecture, Engineering, Construction) industry and there is a significant increase of the adoption of BIM to support planning, design, construction, operation and maintenance stages due to the rapid development of computer application (Volk, Stengel, & Schultmann, 2014). BIM is becoming a systematic method as well as a process that is changing the project delivery (Porwal & Hewage, 2013), designing (Liu, 2014) and the communication and organisational management of construction (Hardin, 2011).

BIM can be identified as a modern construction management process, which can create object based multi-dimensional parametric models. Those parametric models are used as a tool for construction project management during their life cycle. To achieve these targets, various tools and methods have been using in the construction industry (Race, 2012). As construction projects are very unique and very complex, it needs more and more high amount of resources. Because of this complicated nature, adoption of BIM is not that much simple.

Applying BIM in to AEC industry can be seen to some extent as a systematic way to handle risk. Most of the projects have applied the BIM into the design and construction phase. Proper collaboration and communication environment of BIM automatically facilitate the early risk identification in construction industry (Dossick & Neff, 2011; Grilo & Jardim Goncalves, 2010). Most of the researchers found that BIM is an advanced tool to manage design errors, quality and the budget of the projects.

2. Risk

Various types of definitions can be identified for the term of “risk”. According to Olsson (2008) there is no unitary definition for risk even though risk is widely used in construction industry. Moreover, Rowe (1997 as cited in Taylor & Mbachu, 2014) identified risk as a probability of giving unwanted outcome of an event or activity. Both Royal Society (1991 as cited in Edwards & Bowen, 1998) and CIDB (2004) have viewed that the probability of incidence of an event or activity which give the hostile result on the targets/objectives of the project. Mainly these two definitions are focusing on risk event which create negative influence on the project objectives. Taylor and Mbachu (2014) has viewed a different aspect about this area which create positive outcome of risk events come up with the probability of risk.

According to the Taylor and Mbachu (2014) opportunities and risks are considered as equivalent. Even though, according to the Loosemore, Raftery, Reilly, and Higgon, (2006) it is totally different. It says that the opportunities and risks have their own characteristics if it looks like as same. In generally, most of the definitions clearly state that risk is a term which gives the negative impact on the project.

2.1. CONSTRUCTION RISK

The following risk categorisation figure is developed by using direct studies as well as other risk related studies done by Bunni (2009), Kartam and Kartam (1999), Thompson and Perry (1998), Amarasekara (2009), Perera, Rathnayake, Rameezdeen, (2008), Osipova and Eriksson (2013) and Gunathilake and Jayasena (2008).

The research is mainly focused on design delivery risks. Following risk can be identified as most critical design delivery risk in construction industry.

- Design error and omission.
- Design process takes longer than anticipated.

- Stakeholders request late changes.
- Failure to carry out the works in accordance with the contract.
- Defective design.
- Deficiency in drawings and specifications.
- Frequent changes of design by designers.
- Drawings and documentation not issued on time.
- Lack of knowledge, experience and work done in haste.
- Not knowing about the new technological improvements.
- Lack of communication within design team adversarial relationship within the team.
- Failure to account for foreseeable problems.
- Poor constructability and buildability.

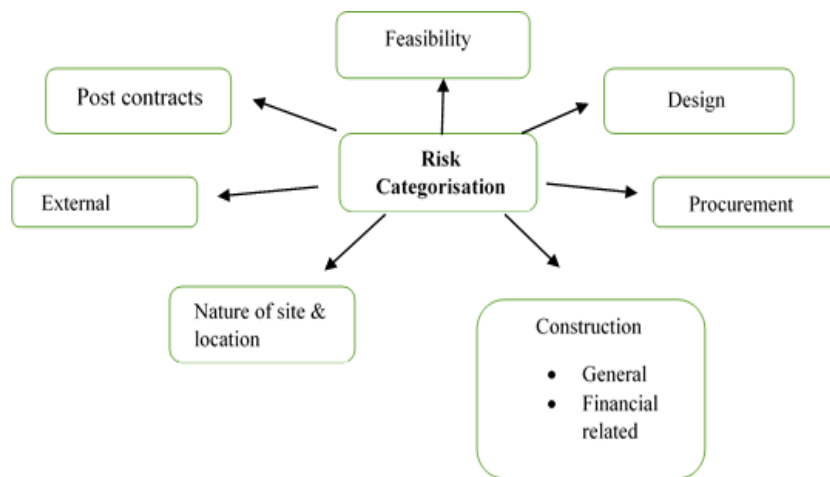

Figure 26: Risk Categorization

3. Concept of Building Information Modelling (BIM)

BIM can be identified as a task specific software tool which uses in the initial stage to the end of the life time to generate building data (Deutsch, 2011). To manage the essential building design and projects data, BIM can be involved as a methodology throughout the life cycle (Bilal, 2009).

BIM systems can be identified as software systems which include BIM design applications. Using local area network (LAN) or the internet, system can be connected to each other (Eastman, Teicholz, Sacks, & Liston, 2011). So many data can be produced by using BIM and those data can be used for several uses. Even though AEC industry was showing an objection for the BIM, most of the countries have been getting the advantages of this technology.

3.1 BIM EXECUTION PLAN

BIM execution plan is used to imply opportunities and responsibilities of each party who are involving in the project work flow. Basically, following facts should be addressed by the completed BIM Execution Plan;

- Appropriate uses for a BIM on a project.
- Along with a detailed design and documentation of the process for executing BIM throughout a project's lifecycle.

To achieve maximum benefits through BIM implementation, team can follow and always monitor their progress with the plan. Following steps clearly shows the structured procedure for creating and implementing BIM Execution Plan.

- Identify high value BIM uses during project planning, design, construction and operational phases.
- Design the BIM execution process by creating process maps.
- Define the BIM deliverables in the form of information exchanges.
- Develop the infrastructure in the form of contracts, communication procedures, technology and quality control to support the implementation.

4. Data Analysis

4.1 CONDUCTING QUESTIONNAIRE SURVEY

Questionnaire survey was carried out with 31 professionals in the construction industry, in order to identify the current design delivery risk level in the Sri Lanka. Here, mainly considered about the frequency of occurrence level separately and impact level separately. Further, identified the current risk level and rank them according to the RII value of the risk factors. Microsoft Excel software is used for data analysis and interpretation which is having more benefits as accuracy and time saving. Both RII value of frequency of occurrence and the impact was used to prioritise risk factors. It was easy to refer single RII value rather than considering both RII values at the same time.

4.2 SEMI STRUCTURED INTERVIEWS

Questionnaire survey was used to identify the current risk rate in the construction industry as frequency of occurrence level and impact level separately. This method is used to identify whether there is any change in the risk level after adopting BIM in to the process. Furthermore, identified reasons if there were any change due to the BIM implementation. Here, an assumption was made that there is no effect on the impact level from the BIM implementation. That's mean BIM effects on frequency of occurrence level only. At the end it directly change the total risk level even impact level is not changed. Six number of semi structured interviews were carried out to fulfil final objective of the research. Content analysis is a suffuse technique that can be used to analyse qualitative data which give the simple and clear picture about the data. Finally, NVivo version 10.0 which is developed by the QSR (Qualitative Solutions and Research Limited) has selected to generate codes, ability to link.

5. Research Findings

5.1 QUESTIONNAIRE SURVEY

According to the calculations, mean rate and RII values for frequency of the occurrence can be summarised as follows.

Table 1: mean rate and RII values for frequency of the occurrence

No	Risk Factor	Frequency of Occurrence-Mean Rate	Frequency of Occurrence - RII _r
R1	Frequent changes of design by designers	4.613	0.923
R2	Stakeholder request late changes	4.452	0.890
R3	Failure to account for foreseeable problems	4.161	0.832
R4	Lack of communication within design team adversarial relationship within the team	4.097	0.819
R5	Deficiency in drawings and specification	4.065	0.813
R6	Design process takes longer than anticipated	4.000	0.800

R7	Design error and omission	3.871	0.774
R8	Lack of knowledge, experience and work done in haste	3.839	0.768
R9	Drawings and documentation not issued on time	3.516	0.703
R10	Failure to carry out works in accordance with the contract	3.516	0.703
R11	Not knowing about the new technological improvements	3.387	0.677
R12	Defective design	3.129	0.626
R13	Poor constructability and buildability	2.968	0.594

Impact mean rate and RII values were also calculated according to the formula. It can be summarised as follows;

Table 2: Impact mean rate and RII values

No	Risk Factor	Impact-Mean rate	Impact RII
R1	Design error and omission	4.839	0.968
R2	Defective design	4.516	0.903
R3	Deficiency in drawings and specification	4.387	0.877
R4	Drawings and documentation not issued on time	4.387	0.877
R5	Failure to account for foreseeable problems	4.290	0.858
R6	Lack of knowledge, experience and work done in haste	4.226	0.845
R7	Frequent changes of design by designers	4.226	0.845
R8	Design process takes longer than anticipated	4.129	0.826
R9	Failure to carry out works in accordance with the contract	4.129	0.826
R10	Stakeholder request late changes	4.097	0.819
R11	Lack of communication within design team adversarial relationship within the team	4.065	0.813
R12	Poor constructability and buildability	4.065	0.813
R13	Not knowing about the new technological improvements	3.419	0.684

According to the previous calculations, RII_f and RII_i were calculated separately. Risk level for the identified thirteen design delivery risks have been calculated by multiplying RII_f and RII_i values. Following table clearly shows current design delivery risk rate in Sri Lankan construction industry.

Table 3: Current design delivery risk rate in Sri Lanka

No	Risk	Risk Rate	Rank
1	Frequent changes of design by designers	0.780	1
2	Design error and omission	0.749	2
3	Stakeholder request late changes	0.729	3
4	Failure to account for foreseeable problems	0.714	4
5	Deficiency in drawings and specification	0.713	5

6	Lack of communication within design team adversarial relationship within the team	0.666	6
7	Design process takes longer than anticipated	0.661	7
8	Lack of knowledge, experience and work done in haste	0.649	8
9	Drawings and documentation not issued on time	0.617	9
10	Failure to carry out works in accordance with the contract	0.581	10
11	Defective design	0.565	11
12	Poor constructability and buildability	0.482	12
13	Not knowing about the new technological improvements	0.463	13

5.2 SEMI STRUCTURED INTERVIEWS

It is clear that the effect of the BIM implementation can be identified in many ways. Some are directly affected and some are not. Therefore, identifying most suitable and most effective way is the best practice.

Table 4: Impact on risk factor

No	Risk factor	Risk level will decrease	Risk level will increase	Risk level will not change
1	Design error and omission	√		
2	Design process takes longer than anticipated	√		
3	Stakeholders request late changes	√		
4	Failure to carry out the works in accordance with the contract			√
5	Defective design	√		
6	Deficiency in drawings and specifications			√
7	Frequent changes of design by designers			√
8	Drawings and documentation not issued on time			√
9	Not knowing about the new technological improvements		√	
10	Lack of communication within design team adversarial relationship within the team	√		
11	Failure to account for foreseeable problems	√		
12	Poor constructability and buildability			√
13	Lack of knowledge, experience and work done in haste		√	

6. Conclusion

According to the findings of the study it can be concluded that, there is a considerable impact on design delivery risk level after adopting BIM concept. From the analysis, it stated that there are situations like risk level will reduce, risk level will increase, and risk level will not change. All these three decisions were taken based on the opinions of experts who have deep knowledge on BIM. When analyse the details,

an assumption was made that there is no change in RII value after adopting BIM into the system. Mainly, when some risk's risk level is not going to change after implementing BIM concept means that risk is not affected by BIM. From the analysis it is identified that there were five risks which are not affected by BIM concept. Those are,

- Deficiency in drawings and specifications.
- Frequent changes of design by designers.
- Drawings and documentation not issued on time.
- Poor constructability and buildability.
- Failure to carry out the works in accordance with the contract

And also, there were six risk factors can be identified as risk which were affected by BIM implementation. Some of the risk's risk level increase and some of the risk's risk level decrease. Following risk can be identified as risk which risk level goes down.

- Design error and omission.
- Design process takes longer than anticipated.
- Stakeholders request late changes.
- Defective design.
- Lack of communication within design team.
- Failure to account foreseeable problems.

Out of thirteen risk factors, there were two risk factors which can be identified as the risk which risk level goes up.

- Not knowing about the new technological improvements
- Lack of knowledge, experience, and work done in haste

Therefore, combining the findings of the research, it can be concluded that there is a considerable impact on design delivery risk in BIM based project implementation in Sri Lanka.

7. References

- Amarasekara, B. 2009. *Construction risks and insurance (Principles of insurance policies and claims) [Seminar, Handout]*. Institute of Construction Training and Development (ICTAD), Colombo, Sri Lanka.
- Bilal, S. 2009. *Building information modelling framework: A research and delivery foundation for industry stakeholders*, Automation in Construction, 18(3), 357-375. doi:10.1016/j.autcon.2008.10.003
- Bryde, D., Broquetas, M., and Volm, J. M. 2013. *The project benefits of Building Information Modelling (BIM)*. International Journal of Project Management, 31(7), 971-980. doi:10.1016/j.ijproman.2012.12.001
- Bunni, N.G. 2009. *Risk and insurance in construction (2nd ed.)*. New York: Spon Press.
- Burchett, J. F., Tummala, R., V. M., and Leung, H. M. 1999. *A world-wide survey of current practices in the management of risk within electrical supply projects*. Construction Management and Economics, 17(1), 77-90. doi :10.1080/014461999371844
- Construction Industry Development Board (CIDB). 2004. Best Practice Guideline A5: Managing construction procurement risks. CIDB document 1005, 3.
- Deutsch, R. 2011. BIM and Integrated Design. Hoboken: John Wiley & Sons, Inc
- Dossick, C. S., and Neff, G. 2011. *Messy talk and clean technology: communication, problem-solving and collaboration using Building Information Modelling*. Engineering Project Organisation Journal, 1(2), 83-93. doi:10.1080/21573727.2011.569929
- Eastman, C., Teicholz, P., Sacks, R., and Liston, K. 2011. BIM Handbook. Hoboken: John Wiley & Sons, Inc.
- Edwards, P. J., and Bowen, P. A. 1998. *Risk and risk management in construction: a review and future directions for research*. Engineering Construction and Architectural Management, 5(4), 339-349. doi:10.1046/j.1365-232x.1998.54072.x
- Flanagan, R., and Norman, G. 1993. Risk management and construction. Wiley-Blackwell.
- Grilo, A., and Jardim-Goncalves, R. 2010. *Value proposition on interoperability of BIM and collaborative working environments*. Automation in Construction, 19(5), 522-530. doi:10.1016/j.autcon.2009.11.003

- Gunathilake, S., and Jayasena, H.S. 2008. *Developing relational approaches to contracting: The Sri Lankan context*. In Proceedings of the CIB International Conference on Building Education and Research (BEAR), 1528–1541. Retrieved from <http://www.irbnet.de/daten/iconda/CIB11518.pdf>
- Hardin, B. 2011. *BIM and Construction Management: Proven Tools, Methods, and Workflows*. John Wiley & Sons, Indiana, USA
- Hayes, R., Perry, J., and Thompson, J. 1986. *Risk Management in Engineering Construction: A Guide to Project Risk Analysis and Risk Management*, Thomas Telford, London
- Hillson, D. 2013. *Managing risk in projects: what's new?*. Available From: <http://www.risk-doctor.com/pdf-files/mar10a.pdf>
- Kartam, N. A., and Kartam, S. A. 2001. *Risk and its management in the Kuwaiti construction industry: a contractors' perspective*. International Journal of Project Management, 19(6), 325-335. doi :10.1016/S0263-7863(00)00014-4p
- Kululanga, G., and Kuotcha, W. 2010. *Measuring project risk management process for construction contractors with statement indicators linked to numerical scores*. Engineering, Construction and Architectural Management, 17(4), 336-351. doi :10.1108/09699981011056556
- Liu, W. 2014. *Using BIM to improve the design and construction of bridge projects: a case study of a long-span steel-box arch bridge project*. International Journal of Advanced Robotic Systems, 1. doi: 10.5772/58442
- Loosemore, M., Raftery, J., Reilly, C., and Higgon, D. 2006. *Risk Management in Projects*. London and New York: Taylor and Francis.
- Mills, A. 2001. *A systematic approach to risk management for construction*. Structural Survey, 19(5), 245-252. doi :10.1108/02630800110412615
- Olsson, R. 2008. *Risk management in a multi-project environment*. Int J Qual & Reliability Mgmt, 25(1), 60-71. doi :10.1108/02656710810843586
- Osipova, E., and Eriksson, P. E. 2013. *Balancing control and flexibility in joint risk management: Lessons learned from two construction projects*. International Journal of Project Management, 31(3), 391-399. doi:10.1016/j.ijproman.2012.09.007
- Perera, B.A.K.S., Rathnayake, R.M.C.K., and Rameezdeen, R. 2008. *Use of insurance in managing construction risks: Evaluation of contractor's all risk (CAR) insurance policy*. Built Environment, Sri Lanka, 08(02). Retrieved from <http://www.sljol.info/index.php/BESL/article/view/1909/1580>
- Porwal, A., and Hewage, K. N. 2013. *Building Information Modeling (BIM) partnering framework for public construction projects*. Automation in Construction, 31, 204-214. doi:10.1016/j.autcon.2012.12.004
- Race, S. 2012. *BIM Demythified* (2.ed). London: RIBA Publishing
- Rohaninejad, M., and Bagherpour, M. 2013. *Application of risk analysis within value management: a case study in dam engineering*. Journal of Civil Engineering and Management, 19(3), 364-374. doi:10.3846/13923730.2012.744770
- Smith, N. J. 1999. *Managing Risk in Construction Projects*, Blackwell Science, Oxford.
- Taylor, S., and Mbachu, J. 2014. *Profiling and mitigating risks in construction contracts*. Proceedings of 4th New Zealand Built Environment Research Symposium (NZBERS), (p. 1). Available from http://construction.massey.ac.nz/NZBERS-2014_proc_fp_Taylor-S.pdf
- Thompson, P., and Perry, J. 1998. *Engineering construction risks: A guide to project risk analysis and risk management*. London: Thomas Telfora.
- Volk, R., Stengel, J., and Schultmann, F. 2014. *Building Information Modeling (BIM) for existing buildings — Literature review and future needs*. Automation in Construction, 38, 109-127. doi:10.1016/j.autcon.2013.10.023

Samarawickrama, Sumanthri, et al (eds), 2018, "Sustainability for people - envisaging multi disciplinary solution": *Proceedings of the 11th International Conference of Faculty of Architecture Research Unit (FARU), University of Moratuwa, Sri Lanka, December 08, 2018 Galle* pp. 228–243. ©

THE IMPACT OF ARTIFICIAL LIGHTING ON VISUAL COMFORT AND VISUAL SATISFACTION OF PEOPLE

With special reference to outdoor public spaces in Colombo.

BANDARA. A¹, RANASINGHE. S² & HETTIARACHCHI. A³

University of Moratuwa, Moratuwa, Sri Lanka

¹anuradhabandara.93@gmail.com, ²shashi125@yahoo.com, ³anishkah@uom.lk

Abstract

Besides having many benefits on ecological and environmental aspects, urban parks are found to have a predictable impact on human well-being. With the fast paced development, city dwellers have gradually become used to an active night life. In view of this, the use of artificial lighting in urban parks manifests a significance in catering to the psychophysiological requirements associated with night life. This research investigates the impact of outdoor artificial lighting installations on the visual comfort and visual satisfaction of users in popular urban parks in Colombo, Sri Lanka. It attempts in identifying the parameters of human visual satisfaction contributing towards more viable and aesthetically satisfying public outdoor environments. The study was carried out in five popular urban parks namely; Arcade Independence Square, Viharamahadevi Park, Urban Wetland Park, Diyatha Uyana and Galle Face Esplanade. Data collection was done adopting a mix method consisting of questionnaires, in-situ observations, measurements and photographic analyses. Convenience sampling, which is a non-probability sampling technique, was used when selecting the participants explicitly, 5 different samples (n= 12) with an equal number of males and females were tested in the selected 5 urban parks. Light level, brightness ratio, glare, colour rendering and colour temperature were measured to identify the participants' visual comfort. A subjective assessment was adopted to determine the users' visual satisfaction on the aesthetics, safety and security related to the parks. Artificial lighting was found to have a direct impact on human visual comfort and visual satisfaction. The overall visual satisfaction with reference to the user experience under outdoor artificial lighting was found to be correlated with the functionality of spaces. It can be concluded that implementing lighting installations to enhance the important design elements associated with visual comfort and visual satisfaction corresponding with the functionality of the outdoor urban spaces during the night time is *essential*.

Keywords: *Visual comfort, visual satisfaction, outdoor artificial lighting, urban parks*

1. Introduction

Artificial lighting has become an important requirement in the futuristic approach of the developing world. Due to the socio-economic development of Sri Lanka, towns have evolved to cities and the use of nighttime lighting has significantly increased with the construction of urban spaces (Bruederle & Hodler, 2018). Therefore, the application of artificial lighting becomes essential in the field of architecture. What humans create and construct are in favor of human comfort and satisfaction. The ultimate goal of the human being is the pursuit of comfort and satisfaction (Fincher & Boduch, 2009). Hence, visual comfort and visual satisfaction are important requirements for the use of artificial lighting (Farley & Veitch, 2001). Accordingly, this study will investigate the subjective impression of artificial lighting on the visual comfort and visual satisfaction of the users in urban outdoor spaces in Sri Lanka, by looking into different components of landscape architecture and human comfort needs.

1.1 BACKGROUND TO RESEARCH

With the development of a country, urban spaces start to expand and man-made constructions start to consume cities. Dark surfaces made of concrete and asphalt tends to cause temperatures to rise within the close compact of buildings. This makes urban areas warmer and a major factor in smog creation. Park spaces with trees can reduce this effect and also have a positive effect on air pollution and carbon sequestration. Therefore, urban parks can become a great place for social cohesion contributing to good human health and well-being. The city life is very fast paced and stressful and people can use urban parks to relax and participate in leisure activities. Parks amidst the urban topography can contribute to

the city's water management of run off regulation of rain and at the same time help preserve the natural ecosystems of the city (Konijnendijk et. al, 2013).

With the widespread development of public spaces, night time lighting has become a predominant essential in the consideration of safety and comfort for the human population. Hence, some of the basic functions of outdoor lighting in urban parks involve providing safety and security to the occupants that utilize the park. Visual comfort and visual satisfaction are phenomena that in fact have an important stance in the success of the human interaction with urban spaces (Hafiz, 2013). With reference to the current research topic, it becomes apparent that visual comfort and satisfaction which also has a contributory presence, constantly gets overlooked in the implementation process of an urban outdoor space. Only a minority of the designs have administered the installation of artificial lighting systems so as to enhance the effects that substantiate to visual comfort and satisfaction within the parks. Thus, it becomes evident that there are only a countable number of precedents where visual comfort and visual satisfaction is considered when artificially lighting an urban outdoor space.

1.2 SCOPE AND LIMITATIONS

The scope of this study is generalized around the basis of urban parks as a rapidly growing concept in the city of Colombo and how the artificial lighting systems of these urban parks are utilized in consideration of human visual comfort and satisfaction. It looks into the use of artificial lighting and its effects of a variety of popular urban parks in the geographical perimeter within Colombo, which include; Independence Arcade Square, Viharamahadevi Park, Nugegoda Urban Wetland Park, Diyatha Uyana and Galle Face Esplanade with view of the specific features of each park.

The limitations of this study border within the confinements of a time period of four months. These urban parks were selected after a critical evaluation of its specific features that correspond with the use of artificial lighting. The parameters used to measure the visual comfort effects of artificial lighting include light level, glare, brightness ratio, colour rendering and colour temperature. The parameters used to speculate visual satisfaction of the users of the urban parks include; safety, security and aesthetics.

1.3 OBJECTIVES

This research intends to provide empirical evidence by investigating the significance of artificial lighting and determining its contributions on visual comfort and visual satisfaction of the users of urban outdoor parks in Sri Lanka.

1.4 CONTRIBUTIONS

- Contributing to the development plans of the large scale constructions that are increasing throughout the country,
- Contributing to the maintenance and correcting errors of already existing constructs,
- Contributing to the improvement and development of the landscape architecture field in the country.

Ultimately, this study will be able to objectify the consideration of visual comfort and visual satisfaction parameters in future designing and planning of urban outdoor spaces in Sri Lanka to the same level that safety and energy sustainability methods in lighting systems are considered at present.

2. Theoretical Framework: Literature Review

2.1 VISUAL COMFORT AND VISUAL SATISFACTION PARAMETERS

Light facilitates our vision to perceive the physical universe. Therefore, light is the access through which the eye, and thus the human mind, interfaces with the world. Centered on this mechanism of light, the configuration of light in a space can evoke both psychological and physiological responses in humans. Human comfort is derived from human physiological components while human satisfaction is derived from psychological components. In the consideration of artificial lighting, the prominence of visual comfort and visual satisfaction which are measured by their specific parameters are important deliberations in designing outdoor urban spaces.

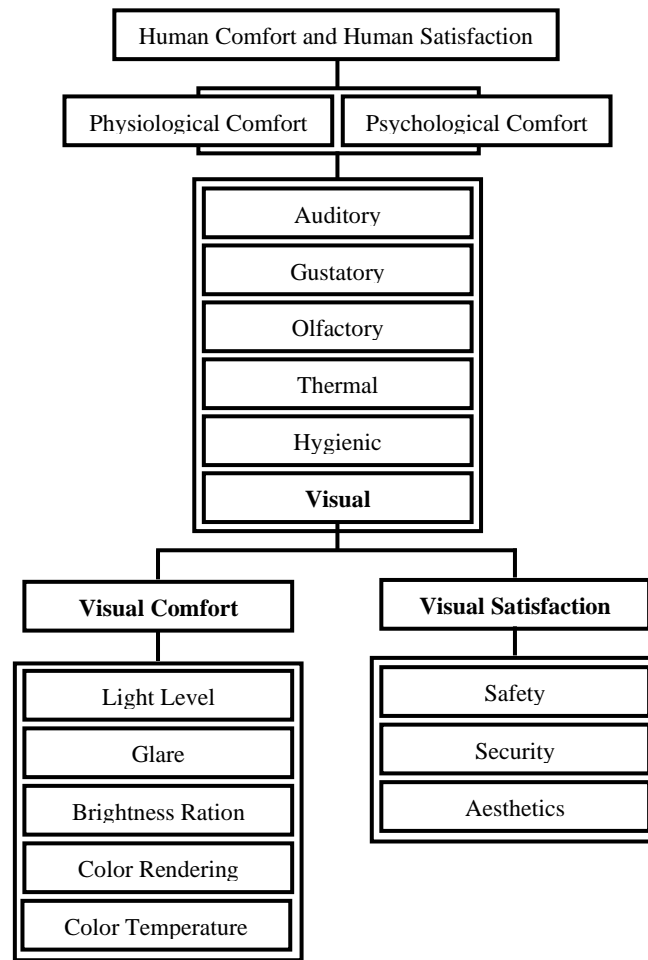

Figure 1, Human comfort and satisfaction

The visual comfort and visual satisfaction of a human is determined by that individual's ability and efficiency to carry out tasks comfortably in terms of their photo-sensory perception. The International Commission on Illumination (2005) documents that the standards on lighting environments specify the following parameters as relevant for visual comfort; glare, luminance levels, luminance ratios and uniformities, color rendering and color temperature (Iacomussi et. al, 2015). In simpler words, the focus of visual comfort includes the parameters of;

1. Light level - This is the quantity of visible light that is emitted from a light source and received by a surface. The level of light is evaluated with reference to the visual sensation experienced (Cuttle, 2008).
2. Glare - Glare occurs when there is excessive and uncontrolled brightness of light. It can cause discomfort and unsatisfying effects (Boyce, 2003).
3. Brightness ratio – Brightness ratio is the difference in luminance that can make an object's representation distinguishable. Human vision is more sensitive to the brightness ratio than luminance; therefore, brightness ratio of light is a major component in detecting visual comfort (Guerrero, 2014).
4. Colour rendering - this is the ability of a light source to display the true color when perceived by the human eye (Billmeyer, 1981).
5. Colour temperature - This is the temperature of a light source. The temperature that is emitted by a light source has important effects on the comfort and satisfaction of the human visual perception (Billmeyer, 1981).

These five parameters can be used to detect visual comfort with regard to the effects of artificial lighting in outdoor urban spaces

In measuring visual satisfaction, three main parameters that contribute to the application of artificial lighting were considered. These include;

1. Safety – Artificial lighting contributes to the visibility of the user, which in turn contributes to safety and feeling of safety. Being able to see where you are going and the obstacles in your pathway provokes a sense of assurance and visual satisfaction (Moyer, 1992).
2. Security – Lighting in the night time has a crucial impact on the reduction of crime rates. Users experience a visual satisfaction in terms of feeling safe and secure in a lighted area in the night time (Moyer, 1992).
3. Aesthetics – Light has the effects of creating elegance for the visual experience. Artificial lighting in the night time is a common tool in enhancing objects and places for the purpose of the users’ visual satisfaction (Moyer, 1992).

2.4 STANDARDS OF OUTDOOR ARTIFICIAL LIGHTING

There are several important standards and recommendations that need to be followed in the implementation of artificial lighting. These standards countenance the integration of illumination requirements into the design principles of various artificial lighting plans in order to optimize necessary lighting practices (IESNA, 2015). In the regard of exterior lighting in public spaces, the Illuminating Engineering Society of North America has recommended certain standards and specifications to maintain the quality of artificial lighting practices.

Table 17 IESNA Lighting Ready Reference
 (Source: The IESNA Lighting Handbook: Reference & Applications)

III. OUTDOOR Locations and tasks		Appearance of space and luminaires	Color appearance (and color)	Direct glare	Light pollution/ trespass	Modeling of faces or objects	Peripheral detection	Point(s) of interest	Reflected glare	Shadows	Source task/ Eye geometry	Sparkle/ desirable reflected	Surface characteristics	Horizontal Illuminance (lux)
Hospitality – Exterior														
Restaurants and dining areas		Very important	Important	Important	Important	Important	Important	Important	Very important	Important	Important	Important	Important	50
Pool areas and terraces		Very important	Important	Important	Important	Important	Important	Important	Very important	Important	Important	Important	Important	50

Key: Very important Important Somewhat important Not important

Sri Lanka follows the standard artificial lighting levels recommended by the Illuminating Engineering Society of North America guide for artificial lighting. Regarding outdoor recreational spaces in the urban context, a minimum horizontal luminance of 50 lux is the recommended lighting level according to the IESNA (IESNA, 2015). This illuminance level should be maintained on both ground and table level of an area.

3. Research Design

3.1 METHOD OF STUDY

This study employs both quantitative and qualitative research methods in obtaining the necessary and required data from the public that utilizes the chosen urban park venues. The urban parks which are located in the city limits of Sri Lanka have been selected so as to support the subject matter under this study. Convenience sampling, which is a non-probability sampling technique, was used. A questionnaire was prepared and distributed to the users of the selected urban parks during week days. The compiled questionnaire consisted of questions that measured the subjective response of visual comfort parameters; lighting level, brightness ratio, glare, colour rendering and colour temperature and the subjective response of visual satisfaction parameters; aesthetics, safety and security.

The subjects were selected according to the convenience of the vicinity to the most populated area focused around a lighting source of the park. A gender unbiased sample of 6 females and 6 males were used from each of the five case studies. Therefore, the whole study comprised of 30 male and 30 female participants (n=60). Lux levels of the focus areas of the parks were measured at approximately 8.30pm using a digital lux meter. This particular time was chosen because it is at this time that artificial lighting systems are in maximum usage and the participants who visited the park after the Colombo city rush hour were observed to be more relaxed and more responsive to answering a questionnaire by this time of the night than those who visited during the weekend. The participants' age range was considered under three categories namely; under 25, 26-50 years of age and over 50 years of age. Education, employment, preferred visiting time, and whether they enjoyed the park in the night time were all documented for the purpose of analyzing the user response with regard to the different lighting conditions of the selected spaces.

3.2 METHOD OF MEASURING AND ANALYSIS

As the most suitable medium of measure likert scales were used to measure the subjective response or opinions of the physical aspect of a stimulus of the participants on a linear continuum (Likert, 1932). The participants were offered a choice of five pre-coded responses. Each of the responses was pre-coded on a negative to positive continuum with the neutral response being negative as well.

- 'Very dissatisfied, Dissatisfied, Neutral, Satisfied, Very satisfied' spectrum scale with '-2, -1, 0, 1, 2', respectively.

Table 18 'Very dissatisfied to very satisfied' likert scale numeration

Answer	Very dissatisfied	Dissatisfied	Neutral	Satisfied	Very satisfied
Numeration	-2	-1	0	1	2
Likert numeration	-2	-1	-1	1	2
Assessment	Dissatisfied			Satisfied	

- Not very well, Neutral, Very well' spectrum scale with '-1, 0, 1' respectively,

Table 19 'Not very well to very well' likert scale numeration

Answer	Not very well	Neutral	Very well
Numeration	-1	0	1
Likert numeration	-1	-1	1
Assessment	Not very well		Very well

Lastly, a score scheme was formulated to determine each parameter's significance.

Table 20 Numerations formulated to visual comfort and visual satisfaction to numerically determine their consecutive parameters' significance

Visual Comfort			Visual Satisfaction		
Parameter			Numeration	Parameter	Numeration
Light level	Q1	10%	20%	Aesthetics	33.33%
	Q2	10%			
Glare			20%	Safety	33.33%
Brightness ratio			20%	Security	33.33%
Colour rendering			20%		
Colour temperature			20%		

4. Data Presentation

4.1 ARCADE INDEPENDENCE SQUARE – COLOMBO

The fish tank area that is located right at the entrance of the park with an area of 3750m² was the space which was chosen for observation. Since this area is surrounded by a combination of shops and restaurants, many visitors of the park were observed lingering in this area. It has a series of fountains and the tank is embedded to the ground with a fibre glass top above the water on which people can walk on. The steps and pathway leading up to the tank is installed with an array of pathlights and step lights and underwater lighting components.. Soft landscape features available in the location such as the trees has been enhanced with uplighting techniques using soft yellow coloured fixtures. Grazing lighting technique has been used to light up the building walls surrounding the focus area of study.

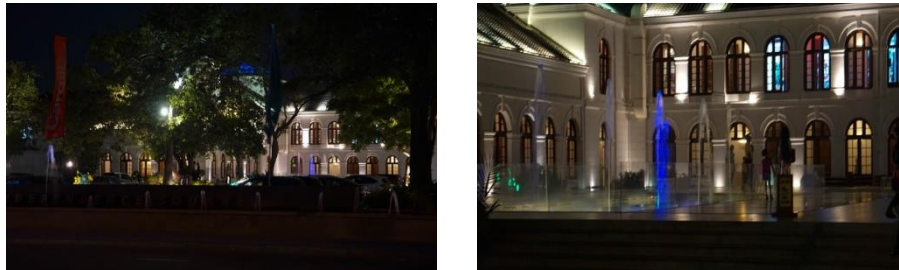

Figure 2, Arcade Independence Square tank area

4.1.1 Visual Comfort

(a) Light Level

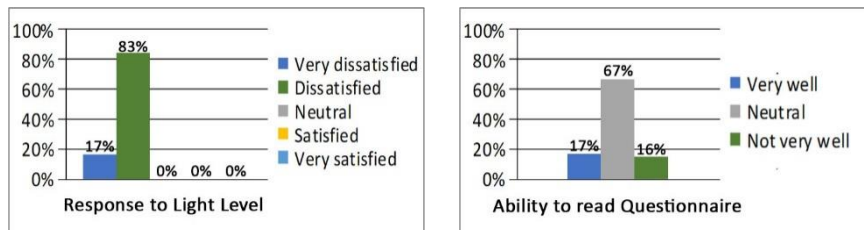

Figure 3, Arcade Independence Square participants' response to Light Levels

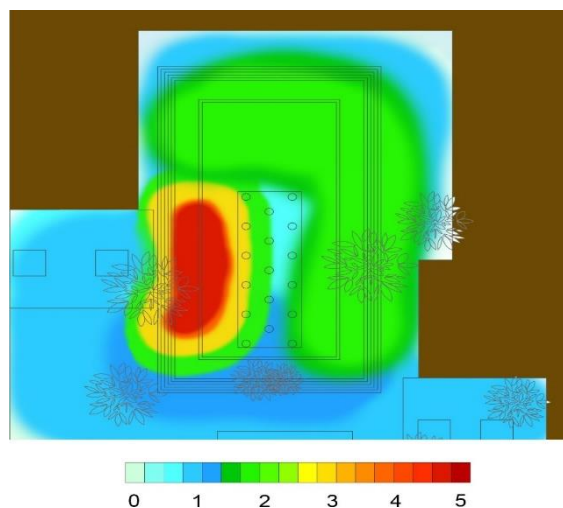

Figure 4, Illuminance levels of tank area as obtained by the digital lux meter and presented on a 0-5 lux range (Recommended standard minimum: 50 lux)

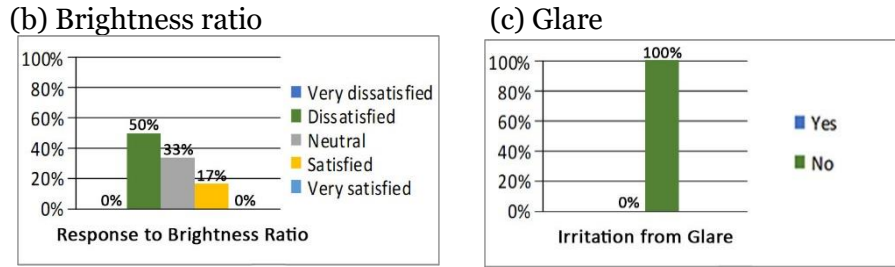

Figure 5, Arcade Independence Square participants’ response to Brightness Ratio and Glare

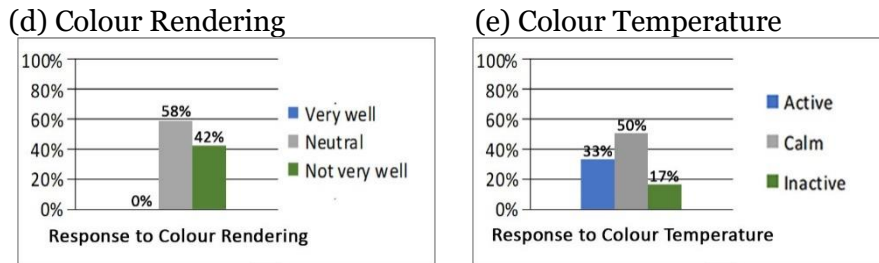

Figure 6, Arcade Independence Square participants’ response to Colour Rendering and Colour Temperature



Figure 7, Arcade Independence Square participants’ response to Visual Satisfaction and Overall Satisfaction

4.2 VIHARAMAHADEVI PARK – COLOMBO

The Buddha statue space which has an area of 7500m² was the focus region of the study. Relative to other areas of the park, most of the artificial lighting systems were installed in this particular area. The pond around the statue is illuminated by underwater lighting fixtures, and the pave way leading up to the statue is lit up by pathway lighting fixtures. From the results of the data obtained from the Viharamahadevi Park Buddha Statue area, it is evident that a majority of the participants were dissatisfied towards the lighting provided.



Figure 8, Viharamahadevi Park Brass Buddha Statue area

4.2.1 Visual Comfort

(a) Light Level



Figure 9, Viharamahadevi Park participants' response to Light Levels

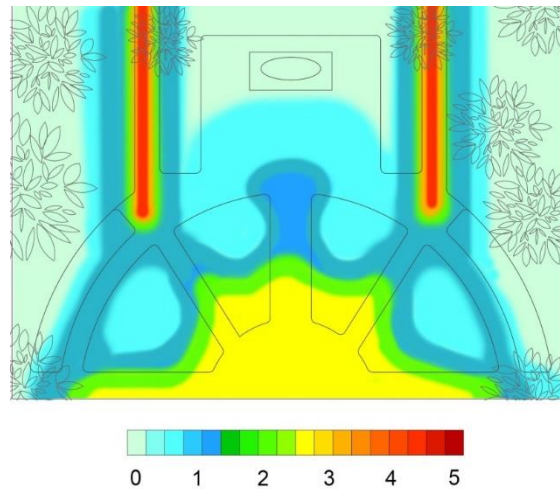
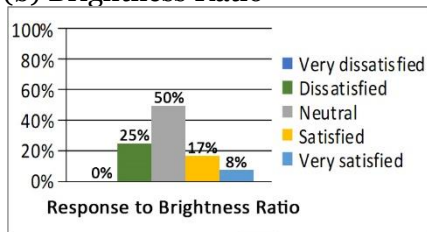

Figure 10, Illuminance levels of Viharamahadevi Park Buddha Statue area as obtained by the digital lux meter presented on a 0-5 lux range (Recommended standard minimum: 50 lux)

(b) Brightness Ratio



(c) Glare



Figure 11, Viharamahadevi Park participants' response to Brightness Ratio and Glare

(d) Colour Rendering

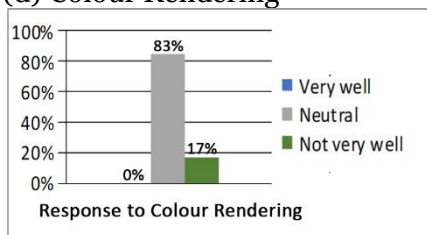

(e) Colour Temperature

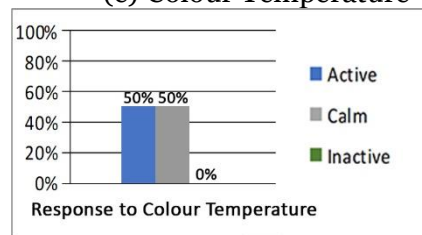
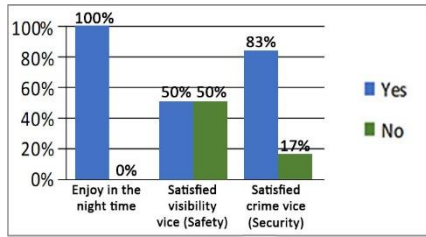

Figure 12, Viharamahadevi Park participants' response to Colour Temperature and Colour Rendering

4.2.2 Visual Satisfaction



4.2.3 Overall Satisfaction

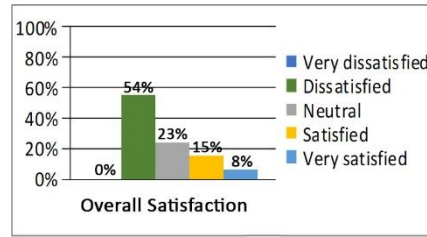

Figure 13, Viharamahadevi Park participants’ response to Visual Satisfaction and Overall Satisfaction

4.3 URBAN WETLAND PARK - NUGEGODA

The pond area of the Urban Wetland Park was chosen as the focus area of study in this case. A prominent crowd was observed in this area, and the lighting installations allowed the visitors to experience the park in a relaxed state. The 12,000m² area consists of a wide variety of lighting fixtures. The up-lighting component has been used to illuminate the greenery in the area and underwater lighting components have been used to illuminate the pond. The jogging and walking track start from the pond area therefore an arrangement of solar panel lighting posts has been used in the down lighting technique around the pond area and pathways while the steps have been lit by pathway lighting and step lighting techniques.

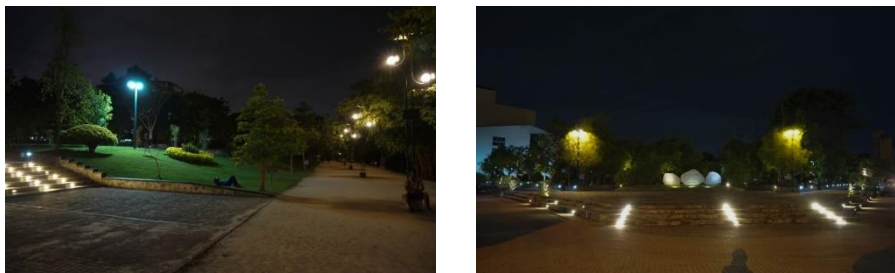

Figure 14, Urban Wetland Park pond area

4.3.1 Visual Comfort

(a) Light Level

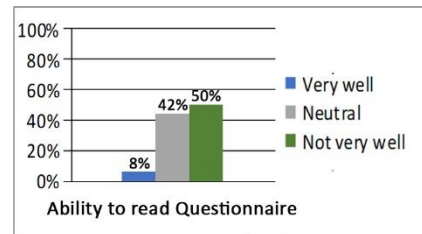
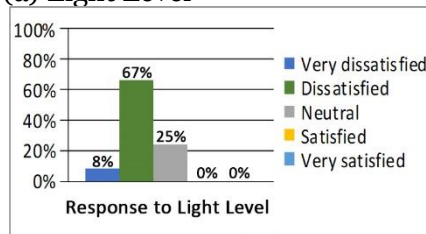

Figure 15, Urban Wetland Park participants’ response to Light Levels

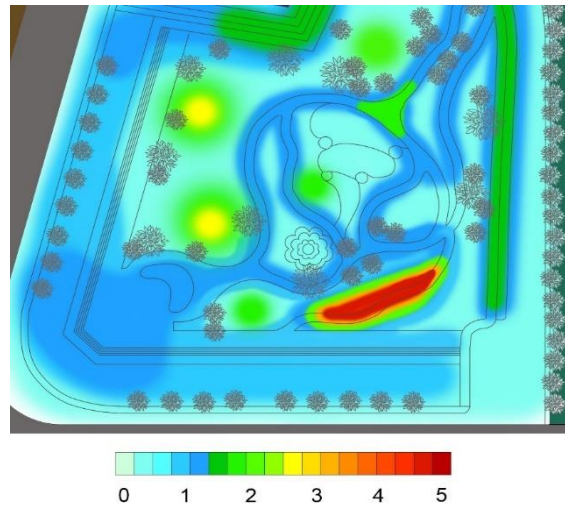

Figure 16, Illuminance levels of Wetland Park pond area as obtained by the digital lux meter presented on a 0-5 lux range (Recommended standard minimum: 50 lux)

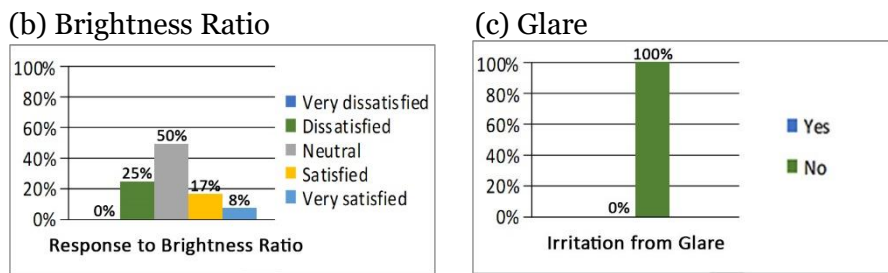

Figure 17, Urban Wetland Park participants' response to Brightness Ratio and Glare

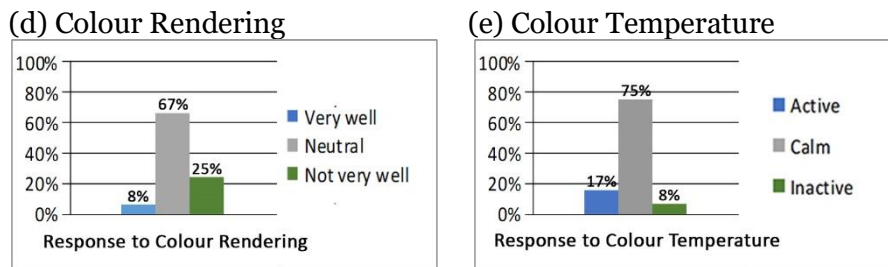

Figure 18, Urban Wetland Park participants' response to Colour Rendering and Colour Temperature

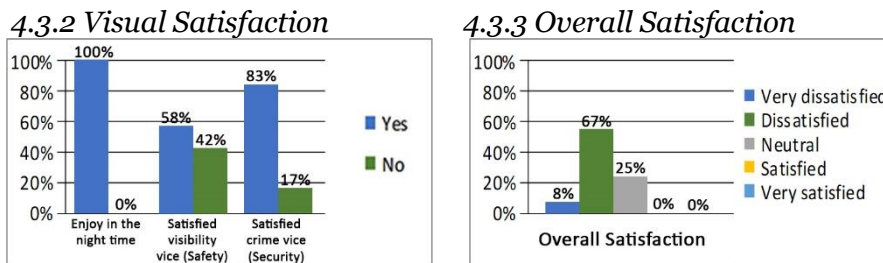

Figure 19, Urban Wetland Park participants' response to Visual Satisfaction and Overall Satisfaction

4.4 DIYATHA UYANA – SRI JAYAWARDHANAPURA KOTTE

The Diyatha Uyana food court which is located in the proximity of the entrance of the park was area investigated. Most of the visitors were gathered in the outdoor, open sky dining region, which stretches over an area of 2500m². The wide variety of delicious cuisines that the Diyatha Uyana food court offers is one of the reasons that this park attracts this large amount of visitors every day. The technique of down lighting has been used to light up this area, with the use of solar powered LED lighting pole installations.

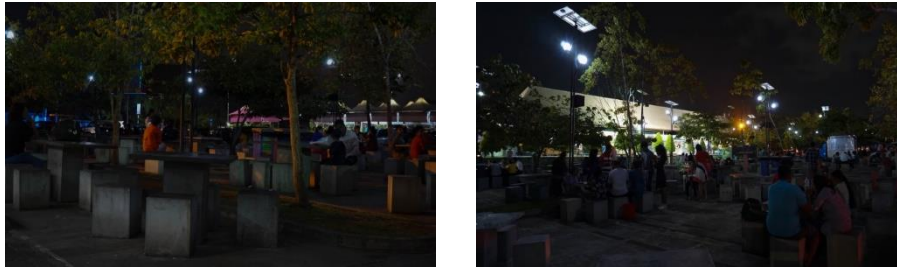

Figure 20, Diyatha Uyana food court dining area

3.1.1 Visual Comfort

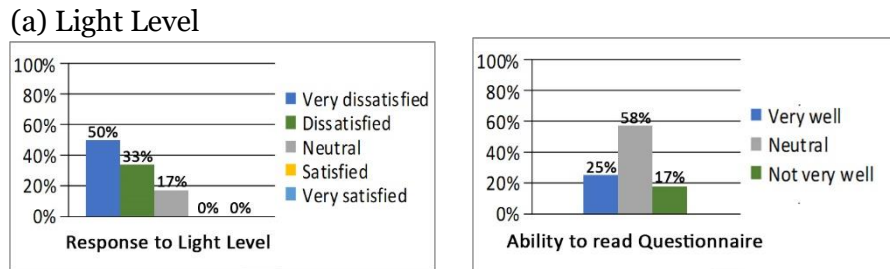

Figure 21, Diyatha Uyana participants' response to Light Levels

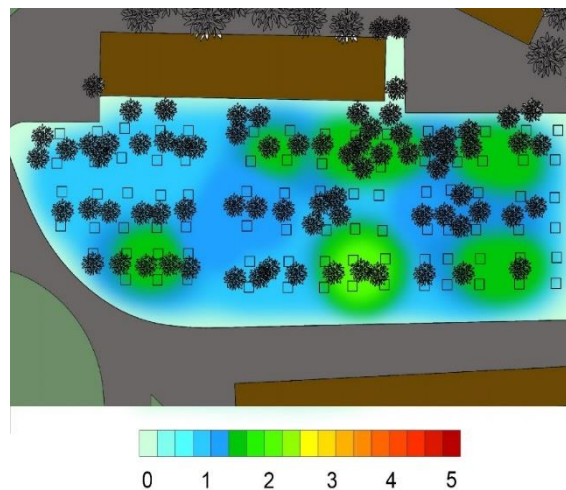

Figure 22, Illuminance levels of Diyatha Uyana food court dining area as obtained by the digital lux meter presented on a 0-5 lux range. (Recommended standard minimum: 50 lux)

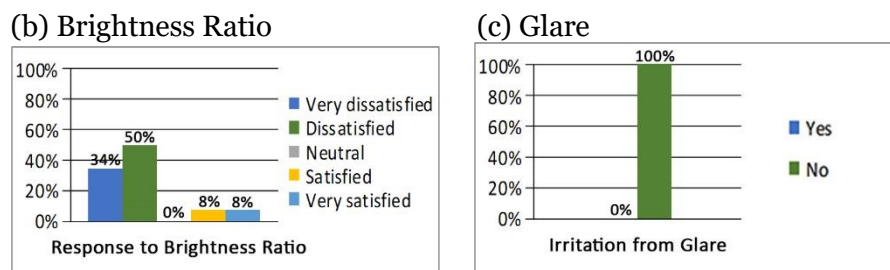

Figure 23, Diyatha Uyana participants' response to Brightness Ratio and Glare

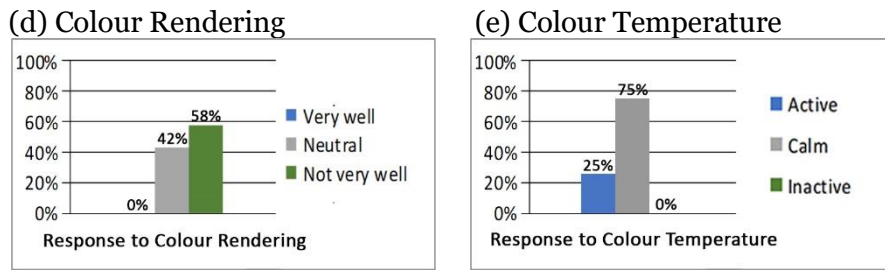

Figure 24, Diyatha Uyana participants’ response to Colour Rendering and Colour Temperature

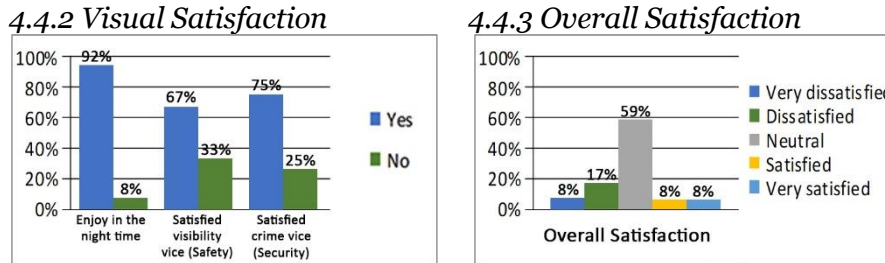

Figure 25, Diyatha Uyana participants’ response to Visual Satisfaction and Overall Satisfaction

4.5 GALLE FACE ESPLANADE – COLOMBO 02

In the night time, the whole park is bustling with people. Most of the visitors were found to linger around the street food vendors lining this 75,000m² area park. The lights from these shops also help illuminate this area and some flood light installations can also be observed in the same area of the vendor shops. Short sturdy vertical light posts also known as bollards are used to provide light to the pathway in the park along the Galle road. The questionnaires were distributed throughout the whole park on the 10th of July, 2018, Thursday.



Figure 26, Galle Face Esplanade

4.5.1 Visual Comfort

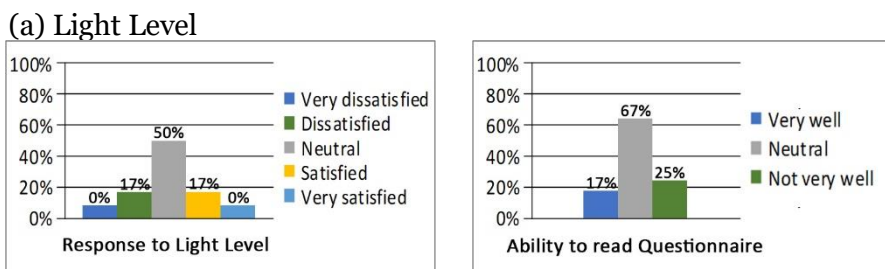

Figure 27, Galle Face Esplanade participants’ response to Light Levels

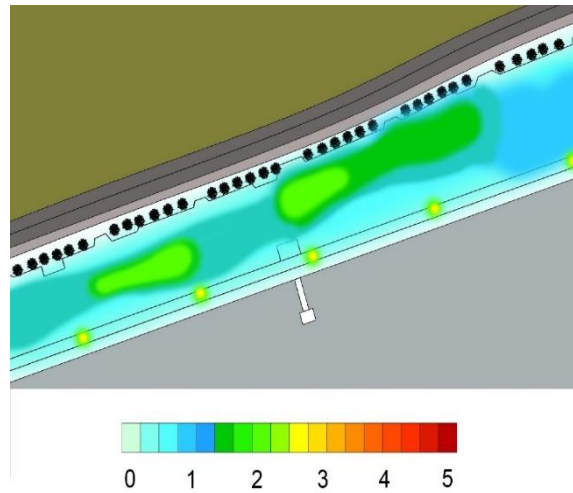

Figure 28, Illuminance levels of Galle Face Esplanade as obtained by the digital lux meter and presented on a 0-5 lux range. (Recommended standard minimum: 50 lux)

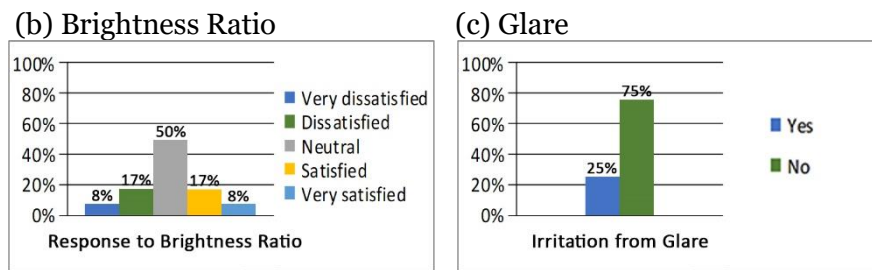

Figure 29, Galle Face Esplanade participants' response to Brightness Ratio and Glare

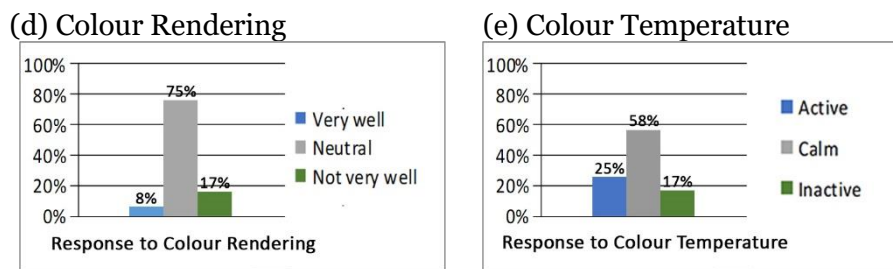

Figure 30, Galle Face Esplanade participants' response to Colour Rendering and Colour Temperature

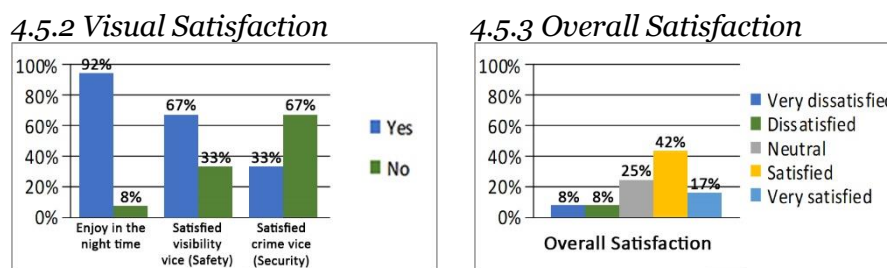

Figure 31, Galle Face Esplanade participants' response to Visual Satisfaction and Overall Satisfaction

5. Analysis

5.1 VISUAL COMFORT

The compilation of the constructive degrees of the parameters; light level, brightness ratio, glare, color rendering and color temperature that determine visual comfort together did not rise above 50% in all

of the parks. According to the standard lighting level that is recommended for outdoor public spaces, all the parks had a significant deficiency of lighting levels, therefore as a result the visual comfort was significantly low. Hence it is evident that light levels have an important association to the subjective impact of artificial lighting on visual comfort.

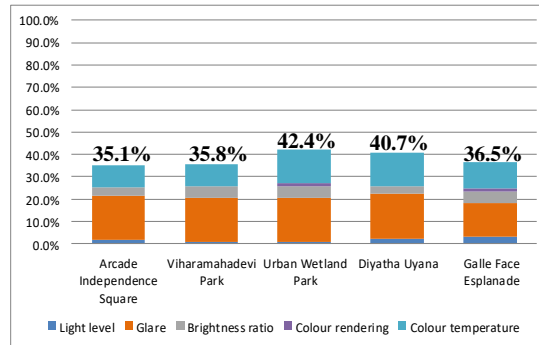

Figure 32, Visual Comfort %

5.2 VISUAL SATISFACTION

Visual satisfaction of the participants was determined by the three parameters; aesthetics, safety and security. The compilation of the determiners that construct visual satisfaction all indicated a considerably high magnitude comparatively to visual comfort. This indicates that other factors such as the social constitution of the users of the park and the topographical disposition of the park had an impact on the visual satisfaction.

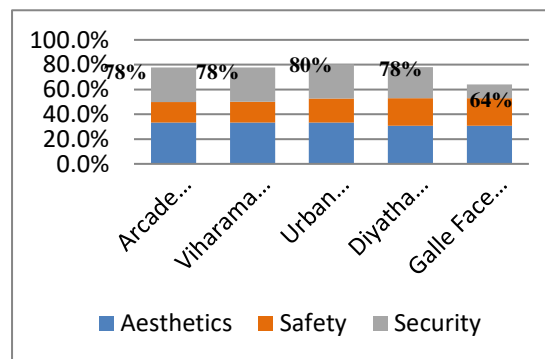

Figure 33, Visual Satisfaction %

Despite the indications towards the determiners of visual comfort being deficient with regard to the artificial lighting systems, the participants' subjective response towards the visual satisfaction determiners were considerably substantiating.

5.3 OVERALL SATISFACTION

The overall satisfaction indicated towards almost all the parks were significantly low. This demonstrates that both visual comfort and visual satisfaction has a correlation towards the overall satisfaction. The lighting intensity of artificial lighting systems has a great impact on the determiners of visual comfort and visual satisfaction. Furthermore, the consideration of the functionality of the space is also important. Meeting the lighting requirements of the reasons people come to a space in the night time, can also attribute to the overall satisfaction.

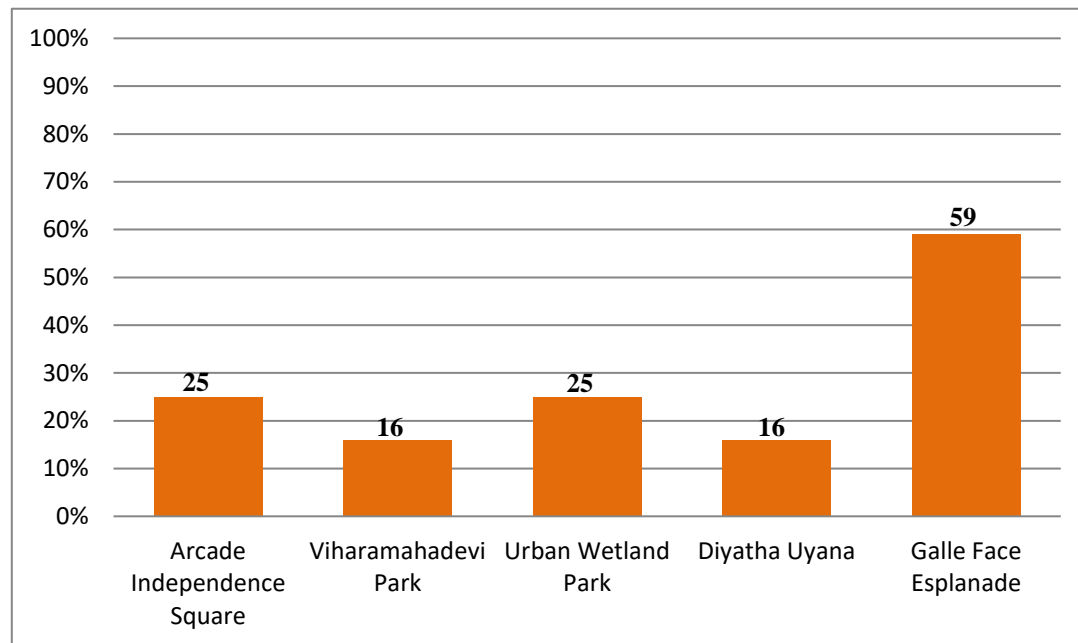

Figure 34 Overall satisfaction %
Source: Compiled by author

6. Conclusion and Recommendations

It was found that, even though the minimum requirements of visual satisfaction were fulfilled, important visual comfort factors such as lighting levels had a psychological influence on the overall visual satisfaction. Accordingly, although the participants indicated a considerable positive regard towards the determiners of visual satisfaction the negative responses towards the determiners of visual comfort resulted a negative indication to the overall visual satisfaction. According to the IESNA (2000), the standard minimum horizontal illuminance level for outdoor public spaces should be maintained at 50 lux. The maximum lux level recorded among all the parks did not exceed 5 lux. Consequently, none of the parks met the minimum standard lighting level requirement, therefore the brightness ratio of 10:3:1 optimum magnitude level was not available as well. Warm white color temperature of 3000K fixtures was used for the majority of the lamps throughout all the parks. This composition of the lighting fixtures with the low lighting levels affected the colour rendering index, causing the participants to misinterpret the true colors of the objects around them.

The constitution of each park and the participants' functional behavior within the parks showed evidence to be important attributes in the subjective response to visual satisfaction. More specifically, the safety aspect of a park with regard to the sufficiency of the horizontal illuminance of the area was also determined by the topographical and functional disposition of the area to the user. Different parks come with different features according to the different temperaments of the landscape and environment. Flat terrains evoke a safer sense within an individual with oppose to areas that have many obstacles such as steps and stairs. Implementing enough lighting levels with regard to the standard recommendations to areas that require precise task lighting would help maintain the subjective impact on visual satisfaction.

Accustomed by the socio-cultural connotations of local context, Sri Lankans are relatively less demanding when it comes to fulfilling the requirements pertaining to human satisfaction. Therefore, it can be observed in general terms that Sri Lankans demonstrate a greater level of adaptation to conditions which are not meeting the necessary comfort standards. Accordingly, the subjects were found to be satisfied even with low levels of lighting in urban parks, though such lighting levels were below the recommend comfort standards. Lack of knowledge in Architects, landscape Architects, Designers and Planners on the impact of different lighting levels in manipulating human psychological and behavioral aspects of night life could be one reason for the incorporation of such low levels of lighting in public places.

Although all the urban parks that were studied in this research had a lack or insufficiency of lighting levels according to the standard recommendations, due to reasons like; lighting fittings not being positioned in relation to the necessary areas properly, the insufficiency of lighting fixtures in the lighting system installations, low wattage levels of the used fixtures, wasted light to unwanted areas, and maintenance of the lighting system not being regulated, causing the overall visual comfort of the participants to be indicated at a low, glare irritation was significantly low to non-existent. Wastage of light was predominantly observed throughout all the parks, this was mainly due to the absence of the correct use of lighting techniques according to the landscape of the parks. If the appropriate techniques had been used the lighting levels would have been complimentary to the visual comfort and visual satisfaction of the users. The usage of some fixtures such as floodlights caused significant glare effects, hence using an abundant amount of small lighting fixtures instead, would give more control over the lighting system of the park and a positive remark on energy consumption.

In conclusion, it was evident from this study that lighting level had the most prominent impact on the subjective impression of both visual comfort and visual satisfaction. Maintaining lighting levels to cater to the necessary task requirements would eventually increase the positive regard on the other essential determining parameters of visual comfort and automatically increase the positive regard towards the overall visual satisfaction.

Thus, the deduction that artificial lighting has a direct impact on human visual comfort and visual satisfaction is evident through the results of this study. Therefore, it can be concluded that implementing lighting installations to provide to the important elements that detect visual comfort would administer beneficial outcomes when designing outdoor artificial lighting plans for urban spaces in the night time.

Low lighting levels may lead to reduced energy consumption and can be seen as a sustainable solution in lighting public spaces. However, sustainability in outdoor lighting encompasses not only a minimized energy consumption but also providing lighting for what is needed, when needed and at the intensity needed ensuring reduced adverse impacts on the user. Accordingly lighting levels in the selected cases have to be re-visited beyond addressing the aspect of low energy to suit the functionality of such spaces which are conducive for associated emotional and behavioral responses in users.

7. References

- Billmeyer, F. (1981) Principles of color technology. 2nd ed. New York: Wiley & Sons
- Boyce, P., Eklund, N., Hamilton, B. and Bruno, L. (2003) 'Perceptions of safety at night in different lighting conditions' *Lighting Research and Technology* 32(2) 79-91
- Bruederle, A. and Hodler, R. (2018) 'Nighttime lights as a proxy for human development at the local level' *PLoS ONE* [online] 13(9), e0202231. available from < <https://doi.org/10.1371/journal.pone.0202231>>
- Cuttle, C. (2008) *Lighting by Design*. 2nd edn. London: Macmillan
- DillLaura, D., Houser, K., Mistrick, R., and Steffy, G. (2015) *The lighting handbook*. 10edn. Illuminating Engineering Society of North America. New York: IES
- Farley, K. and Veitch, J. (2001) 'A Room With A View' *A Review of The Effects of Windows on Work and Well-being*
- Fincher, W. and Boduch, M. (2009) Standards of Human Comfort: *Relative and Absolute* [online] (4-5). available from < https://soa.utexas.edu/sites/default/disk/preliminary/preliminary/1-Boduch_Fincher-Standards_of_Human_Comfort.pdf>
- Guerrero, O. (2014) 'Exploration of Asthenopia due to the ration of direct/indirect light in office environments' Master of Science, Eindhoven University of Technology, Eindhoven
- Hafiz, D. (2013) A Dynamic Simulation Approach for Visual Comfort Evaluation under Daylighting Conditions 2 (1), 65-66
- Iacamussi, P., Radis, M., Rossi, G., and Rossi, L. (2015) Visual Comfort with LED Lighting: Energy Procedia 729-734
- Institute of Lighting Engineers. (2005) *Outdoor Lighting Guide* (1st edn.) Abingdon, Oxon: Taylor & Francis
- Konijnendijk, C., Annerstedt, M., Nielsen, A., and Maruthaveeran, S. (2013) Benefits of Urban Parks: A Systematic Review. Copenhagen: IFPRA
- Likert, R. (1932) 'A Technique for the Measurement of Attitudes' *Archives of Psychology* 140. 1-55.
- Moyer, J. (1992) *The Landscape Lighting Book*. New York: John Wiley

Samarawickrama, Sumanthri, et al (eds), 2018, "Sustainability for people - envisaging multi disciplinary solution": *Proceedings of the 11th International Conference of Faculty of Architecture Research Unit (FARU), University of Moratuwa, Sri Lanka, December 08, 2018* Galle pp. 244–253. ©

IMPACT OF ORGANIZATION PATTERNS IN LANDSCAPE ELEMENTS ON VISITOR LEGIBILITY

A study with reference to Sigiriya

DISSANAYAKE. D. S. P. R.¹ & DHARMASENA J. P.²

Department of Architecture, University of Moratuwa, Moratuwa, Sri Lanka

¹dsammani238@gmail.com, ²jdarch@outlook.com

Abstract

Pattern recognition is important to understand and narrate the world around us. It is possible to develop a language, to communicate relationships between different patterns in surrounding environment to the user which could be used in reading the "legibility" of the space consisting of organization patterns of element. This study focuses on the impact of organizational landscape elements on aesthetic readability of the visitor. Kaplan's, information processing theory is used to study the legibility and the Bells' principles on the organization of elements are used to identify basic organizational patterns as; (1) the Spatial, (2) Structural, (3) the Order.

Effects of each of these patterns on legibility are studied on Sigiriya, a UNESCO heritage site in Sri Lanka and is carried out on two selected spaces where the users' readability is high on the main path. Space A, canter environment of char-bar in water garden, Space B: entry environment of Boulder garden. The results concluded that the similar level of presence of spatial, structural and order arrangements, with minimum variations in a space result in better readability of the visitor than in a space with higher deviation among organizations. And, people judged the space by giving least priority to the structural arrangement of elements.

Keywords: *Legibility; Landscape organization; Order; Structural; Spatial.*

1. Introduction

From the starting point of life, human began to explore, understand and gather information basically from the surrounding environment through five senses. Nevertheless, vision encounter 87% of human perception compared to other senses. Therefore, people grabbed more information from vision centered identification of physical elements and their arrangements. Though, the landscape is composed of the same material, components, or even the same pattern, whilst the nature of perceiving the same landscape may rather different from each other. "Whatever our views, our cultural background or the values we attach to certain landscapes, we perceive them, at the most basic, structural level as patterns." (Bell, 1993). Thus, the way how people read the space, and to what extent do people continue reading the space is an important matter to be considered when space designing as it changes with the basic physical arrangement pattern of landscape. Hence Landscape design is a way of storytelling through element arrangements, composure of land-scape elements would act as a language to understand or to create meanings about space. Whilst only if the visitor able to read the space are viable to understand the story behind the space.

1.1 RESEARCH ISSUES

In the historical context ancient people had created spaces using different arrangement techniques of elements. They have invested more concern about the kind of information and the meaning which they want to interpret from individual space in the design. Finally, number of different spaces with distinct spatial characters and functioning's were all adjoined together to interpret a better meaning as a whole.

Comparatively at present, aesthetic quality of landscapes has been undervalued as they only concern about functional aspects, sur-face appearance and beauty but not the meaning of the space. There-fore,

there is a huge need of exploring ancient space arrangement techniques used for a better space designing in the present and for the future.

The regulation of level of readability of a space would affect for the preference and experience of the people. Due to the different techniques of space arrangement patterns, readability of people varied from place to place. Therefore, there would be a need of finding about different organization patterns of elements used in ancient historic designs.

- Do people really read the spaces through Landscape arrangement patterns?
- If so, then how people had referred Organization patterns in reading Landscapes?

1.2 OBJECTIVES AND CONTRIBUTION OF THE STUDY.

The main intention of the study is to explore how, the different arrangement patterns of landscape elements effects for the aesthetic readability of the visitor to maximize or minimize the quality of experience. Thereby how the spatial arrangement effects for the Unity and Harmony of the overall design is important. Hence, the results can be employed by space designers to conserve and preserve scenic quality in space.

The objectives will be,

- To identify how arrangement patterns in landscape effects readability of normal users.

The findings of the study will contribute to identification of techniques used in designing ancient spaces could be motivated and develop further and generate opportunity for other investigators to identify and research on other influential factors related to field of study. It would be a set of precedence information collection to understand basic organization patterns of landscape elements to maximize human legibility and associated human experience.

1.3 SCOPE AND LIMITATIONS

Sigiriya has been selected as the case study space and thereby two spaces were selected out of Sigiriya. Although Sigiriya is identified a cultural heritage site with international recognition, research only catered in finding how its latent landscape arrangement pattern affected man in process of reading the space through landscape organization principles despite of its other values, due to the limited of time factor.

One hypothesis was taken out and qualitative analysis process proceeded forward using Questionnaire, Interview and photo analysis methods of data collection using adequate measures to get qualitative samples of data. Due to the limitation of time factor sample selection reduces to 20 samples and case study limited to one place.

2. Literature Findings

2.1 ORGANIZATION PATTERNS OF LANDSCAPE ELEMENTS & LEGIBILITY.

2.1.1 *Patterns in the landscape*

Intentionally or involuntarily we would seek order out of disorder. We would have a habit of search for patterns which appear to sense in the information about the surrounding, and aesthetically affiliation of each part to the entire environment.

Pattern is an any frequently repetitive arrangements, specifically a design made as of recurring lines, shapes, or colours on a space. Pattern recognition is important to help us understand and relate to the world around us. We could have developed a language of description and analysis to communicate relationships between different patterns, the processes that change the landscape and our aesthetic and emotional responses to them. How it has been perceived and understood patterns also would depend very much on what is supposed to be looked for and why. For example, a cultural geographer, a farmer,

a physical planner, an explorer, an archaeologist or an army general are likely to describe the pattern of a landscape based on their own knowledge, experiences and what it would provide for them is its affordances, as one would use call them.

We could recognize relationship between arrangement of elements and what to be sensed in the actual space. Above elements would mean the components of environment which combines together to interpret a pattern. According to Bell (1993), when a person is to get involved with a new environment, they tend to investigate the structure and composition of a space as a sense of formal aesthetic response in the first sensory interaction or people search for patterns.

2.2 BASIC ELEMENTS OF VISUAL EXPRESSION.

Landscape design has been an organized collection of landscape elements. But, “In order to make sense of our surroundings we need to be able to separate each constituent part and then to identify it and to re-late it back to the whole scene.” (Bell, 1993) Every landscape element around us despite of man-made or natural, all made up as a combination of four basic elements called “Basic Building Blocks”. “In summary, point, line, plane and volume are the basic mass-space elements of visual expression. Every form of life that has been seen or visualized could be simplified to one of these elements or some combination of them.” (Bell, 1993)

2.3 ORGANIZATION OF BASIC ELEMENTS TO GENERATE PATTERNS.

Basic elements could be organized in different ways within a design to generate patterns with limitless variations. According to (Bell, 1993), in his book, he has talked about three ways of categorizing elements organization principles.

- Spatial - Nearness, Enclosure, Interlock, Continuity, Similarity, Figure and ground.
- Structural – Balance, Tension, Rhythm, Proportion, Scale.
- Ordering – Axis, Symmetry, Hierarchy, Datum, Transformation. (Bell, 1993)

2.4 LANDSCAPE LEGIBILITY AND PREFERENCE.

“Legere” is the Latin word for Legibility, which describe the meaning as ‘to read’ and means. It can be further described in two ways, a. “capable of being read or deciphered” or b. “capable of being discovered or understood” (Jerpåsen & Tveit, 2014).

Related to landscape, legibility would be “understanding the environment based on elements like landmarks that allow people to comprehend and function effectively” (CHENG, 2007) Clearness of the surrounding information has existed in landscape were remarks as "Legibility," by (Lynch, 2005). Relatively it affects to identify and systematize coherent patterns without any difficulty. Visual identification of patterns with easily noticeable symbols was legible. Relative to the city context districts, landmarks, pathways and edges are those of easily recognizable symbols of legibility according to Calvin. (Lynch, 2005).

Term legibility would differ according to archaeological context and urban design/ architectural context. (Dobson, 2010, p. 210) Former context it has been the “clarity of a readable past in the present”. Latter it has been a concept which precise “how difficult or easy it is to ‘read’ a particular landscape”. (Jerpåsen & Tveit, 2014) It also must have been a factor in comprehending people’s and landscape attachments to each other. (Drenthen, 2011; Jerpåsen & Tveit, 2014)

“It appears that people's preferences were based on three major aspects of the scenes they were inspecting. They prefer settings they can make sense out of, those they can comprehend with dispatch. They also prefer scenes that promise additional information.” (Kaplan & Wendt, n.d.) Accordingly, man would generously be responding to the landscapes with above exact characteristics. Then “legibility” and “Land-scape Quality” are the determinants of preference.

Information processing theory

Theory put forward by Rachel and Stephen Kaplan in 1989 related to Landscape visual preference. Human would tend first, to explore and then understand compositions of environment as fundamental reaction. Kaplan has suggested legibility as; understanding the immediate environment easily by means of elements, which would promote users’ effective understanding and action of the space. (CHENG, 2007). Complexity, Mystery, Coherence and Legibility are the subjective variables of preference. (CHENG, 2007)

Kaplan has explained Coherence and identifiability as two aspects of information regarding legibility. “Identifiability involves making sense out of what is depicted.” (Kaplan & Wendt, n.d.) If user tend to perceive what exactly designer concern to depict in the space of design, it is affiliated with the rule of “form follows function”. (Kaplan & Wendt, n.d.)

Availability of Information	Needs	
	Understanding	Explore
Immediate (2D)	Coherence	Complexity
Inferred(3D)	Legibility	Mystery

Table 21; Kaplans Information Processing Framework

Identifiability would mainly concern of generating more readable landscapes. Similarly, Litton's (1972) has stated that “Vividness” or the clarity and differentiations of form and space could express the identifiability. (Staats, n.d.)

Source of Information	Degree of Inference	
	Less	More
Present Legibility	<i>Coherence</i>	<i>Identifiability</i>
Future information promised	<i>Complexity</i>	<i>Mystery</i>

Table 22; Stephan Kaplan's Table of Landscape Dimension.

Kaplan has characterized coherence as how well a scene "hangs together," According to Kaplan S.,1970 coherence has been the easiness in referring which constituent could hold the organization of a scene. “Making sense” of the organization of setting makes the space more coherent. It would have expressed the degree of spatial arrangement of landscape elements according to Kuiper (2000).

3. Theoretical framework

Lease disturbance to distinguish each character one by one in a text when reading is legibility, but it is not readability. Easiness in distinguishing single elements, sentences and an exclusive paragraph separately as a whole is readability. Hence legibility is an integral part of readability from the point of reading. (Wikipedia, n.d.). Although con-text is different from reading overall process is similar to reading.

According to Kaplan coherence would be the overall unity among visual arrangement of elements in a scene. And it can be likened with unity, as it is the factor which has afforded the sense that all the parts relate to each other in a scene. Simply the sense of order and organization of composition is coherence. Since Kaplan has stated about “the patterns of brightness, size, and texture” in a scene, theoretical framework has widened using more detailed organizational principles.

Coherence could be basically categorized in to three by means of how the elements would be organized in a space.

a. Relative spatial standing of each element and communication and interaction amongst each other. – Spatial Organization.

E.g. in the process of reading it can be express as “A collection of different words to create a meaningful sentence.” Similarly, arrangement of individual elements in space would create and give the particular meaning of the space.

b. Way of how the different parts of design gets fit together or “The way in which the fragments of a system or object are organized” (Cambridge Dictionary)– Structural Organization. A collection of number of different meaningful sentences to create a whole para-graph.

c. Order in organizing landscape elements. - Order Organization. (Bell, 1993)

e.g. The way of how pleasing and understandable manner the story has been presented to the reader. Including justification, highlighting some parts of the sentence and font patterns arrangement to catch the reader.

3.1 RESEARCH DESIGN

Considering the Kaplans and bells principles author implement-ed a literature base as follows.

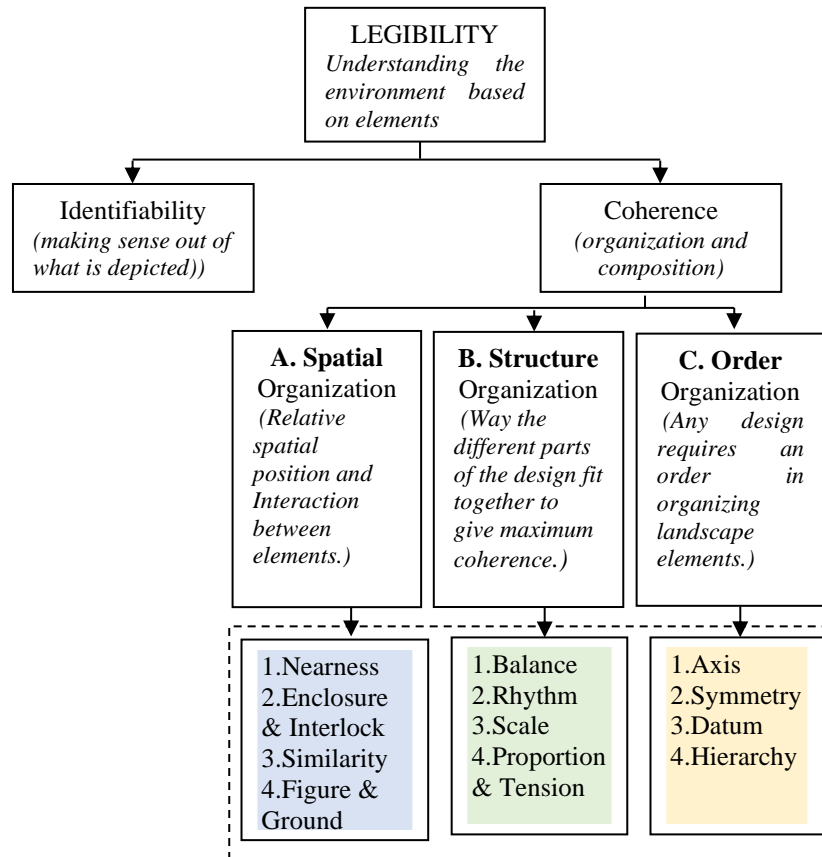

Table 23; Table compiled by the Author according to Kaplan's Information processing Theory & Bell's organization principles.

It was understood that legibility could be analyse as a whole trough the three organization patterns. Comparative to the study author implement-ed a framework to understand the relative organization factor and there-by to understand the variation of factor in particular state for the ease of the study. (Kaymaz, 2012)

	Factor	Arrangement feature	Considering effect of the feature	Calculating Effect	Legibility
Spatial	Nearness	<i>Sight of elements as groups</i> ↑	<i>Chaotic Nature</i> ↓	<i>Nearness</i> ↑	% of reading
	Enclosure & Interlock	<i>Interlocking planes</i> ↑	<i>Feels space as a unit</i> ↑	<i>Interlock & Enclosure</i> ↑	
		<i>Connection with outside was interrupted</i> ↑	<i>Openness to views vistas</i> ↓		
Similarity	<i>Minimum variation among elements</i> ↑	<i>Familiarity for the context</i> ↑	<i>Similarity</i> ↑		

	Figure & Ground	Level of contrast nature of forms ↑	Suddenly noticed scene or elements ↑	Figure & Ground ↑	
Structural	Balance	Balance nature of element composition ↑	Inbalance feeling due to spatial composition ↓	Balance ↑	% of reading
	Rhythm	Repetition of patterns ↑	feel of a rhythm ↑	Rhythm ↑	
	Proportion	Relative size of elements to each other ↑	Sense of harmony in place ↑	Well Proportion ↑	
	Scale & Tension	Comfortability of size of elements considered to human size ↑	Feel of tension with sizes of elements related to position	comfortable Scale ↑	
Order	Axis	Guid the eye & symbolism of power ↑	Rigidity & sense of power ↑	Axis recognition ↑	% of reading
	Symmetry	Less formal or compatibility of shapes were eliminated ↑	Asymmetry ↓	Symmetry recognition ↑	
	Hierarchy	Visual dominant showing pattern or function ↑	Identification of More dominant features or focus	Hierarchy ↑	
	Datum	Presence or absence reference element which controls & organize other elements ↑	Attention draws to a specific point, place or a object in the space ↑	Datum ↑	

Table 24; Compiled by the Author according to the Bell's Organization Principles.

3.1 CASE STUDY

Sigiriya has been confirmed that it is a space with designed landscape in literature sources, and has a standard reputation about landscape characteristics in international context.

“It is an outstanding example of mid-first millennium planning mathematics, displaying a high degree of sensitivity to the incorporation of irregular, organic natural features in a plan based on an intricate square model” (Bandaranayke., 2005). A world heritage city with an exceptional combination of architecture, hydraulics an engineering, ur-ban planning, garden design and poetry and paintings goes back to 5th century. (Bandaranayke., 2005). Accordingly, Sigiriya selected as the case study space as its Landscape techniques runs back to ancient Sri Lankan context and still its arrangements valid for the appreciation.

From Sigiriya, most critical highly readable two spaces were selected after interviews were,

1. Space A. – Readability of space from the centre of the char-bhag along the pathway in Water garden complex.
2. Space B - Readability of space from entry environment of the Boulder garden complex.

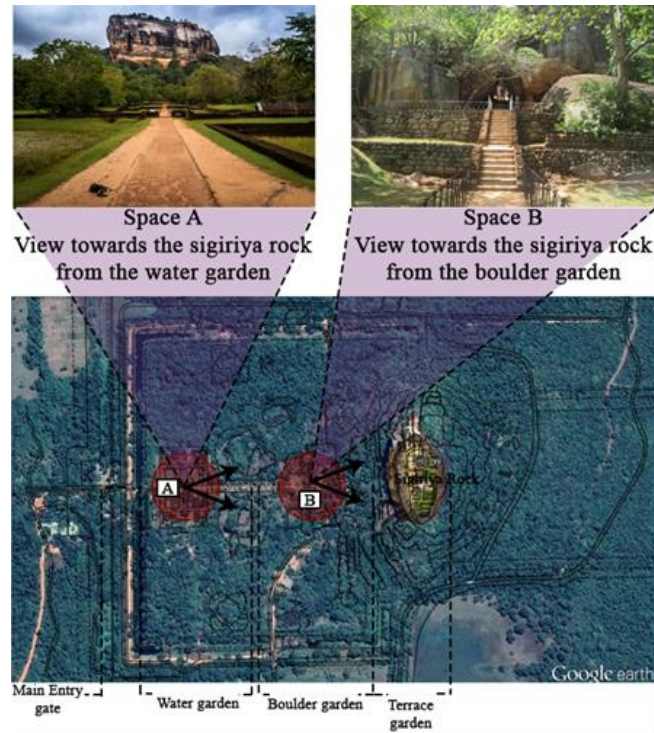

In this qualitative study, data were collected through interviews, questionnaires, onsite observations and selected 20 participants at each space.

4. Data presentation & discussion framework

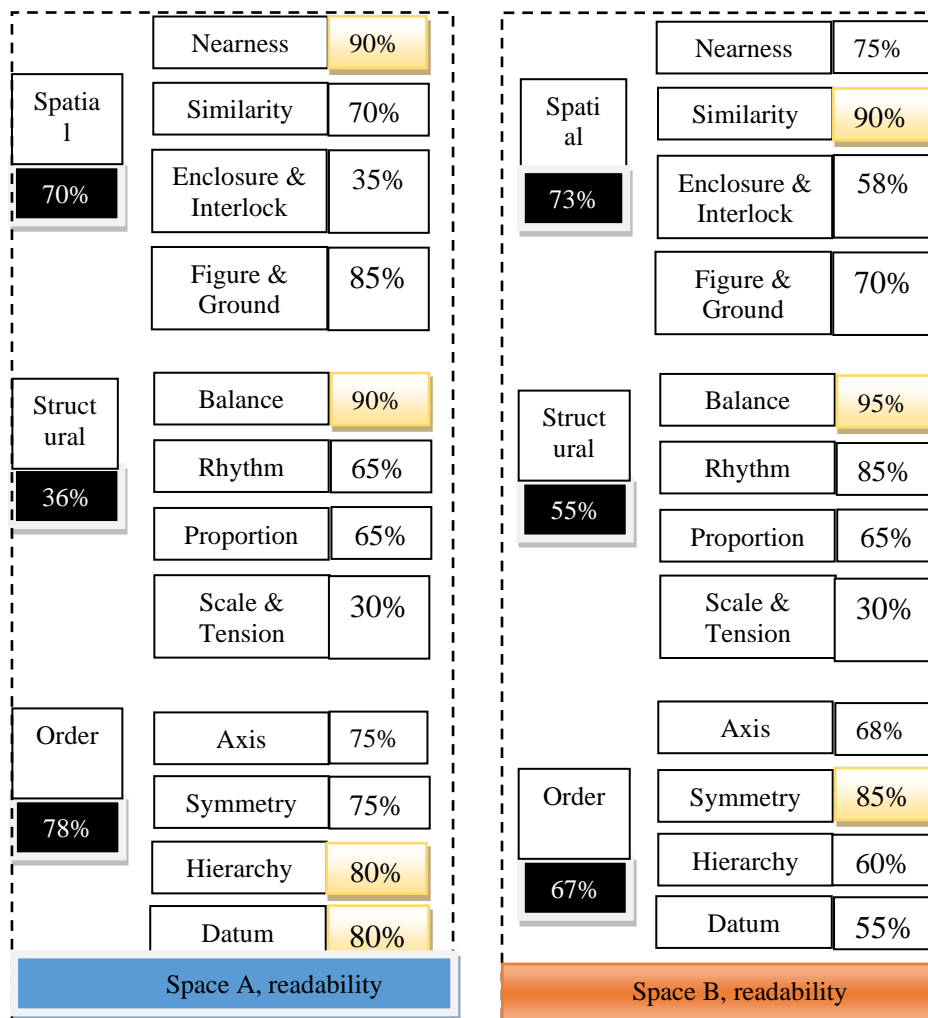

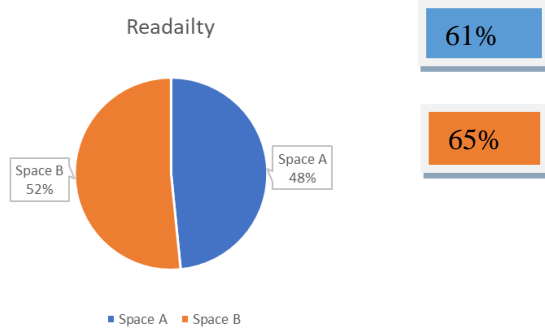

Both spaces together Landscape organization readability percentage of space B is 52% and space A, 48%. The results concluded that the readability of space B is higher than that of the space A.

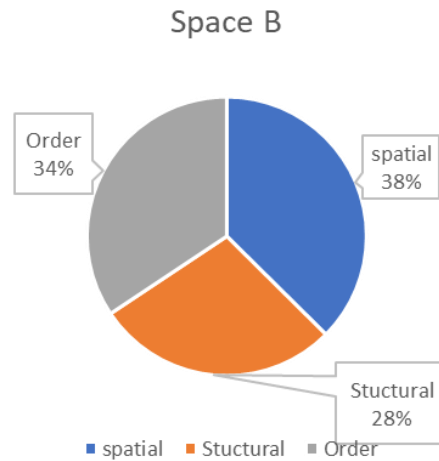
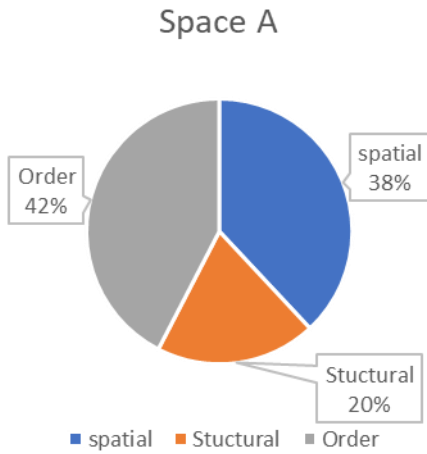

Legibility percentage of Landscape Organization

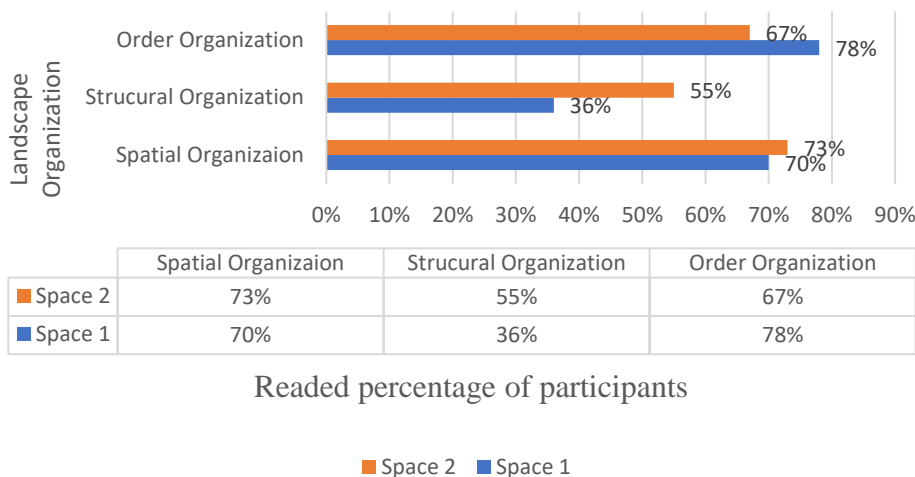

Readed percentage of participants

Readable proportions of all three organizations in space B seems much similar to each other than in Space A.

Compared to the two spaces readability percentage of spatial Organization in space A is 70% and space two is 73%. Only 3% variation is visible. It seems that spatial readability of organization of space A as well as space B are almost similar to each other. It is further shown in the chart as well.

Compared to the two spaces readability percentage of structural Organization in space A is 36% while space B is 55%. Clear variation of 19% is visible.

Compared to the two spaces readability percentage of order Organization in space A is 78% and space two is 67%. There has been a slight variation of 11% visible.

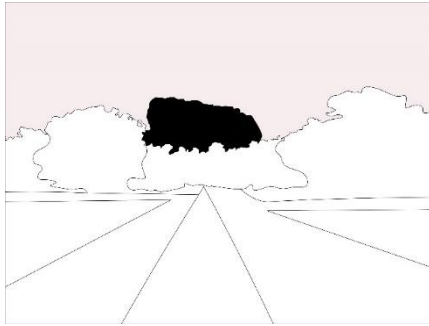

Figure 27;View towards Sigiriya from Space A

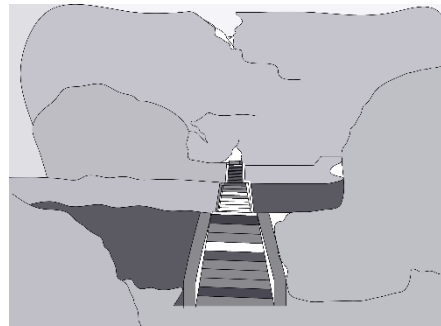

Figure 28;View towards Sigiriya from Space B.

5. Conclusion

Legibility consists of these three aspects and from the study its evident that where all three aspects are reasonably equal there's a better more chance of people reading or understanding/ enjoy space in a better manner where else regardless of differences if one aspect dominate from other two aspects, then proportionately the readability is low in the spaces. It was understood that legibility could be balanced as a whole when the three organization patterns, spatial, structural and order exists in balance and harmony with each other. Furthermore, from the three aspects it is evident from the study structural organizational aspect is the aspect, the smaller number of visitors tent to read. That means Balance ness, Rhythm, Proportion and Scale & tension of the arrangement's aspects were occupied a minor priority when reading the space.

But careful increasing certain aspects to limited or significant increment can give a special character to the space. These three can be manipulated to give a special character using the increase and decrease of related features. E.g.: Nearness factor is prominently affected for the increase of spatial readability in Space A. Nearness factor in space A is 90% while space B it is 75%, reason for the high readability in factor in space A compared to the space B is less chaotic nature due to the distance between view point and the sceneries is high and therefore characteristically elements can be identified as groups.

But with referent to the earlier matter it is important to highlight that increasing the structural organization as the diminishing other two aspects will not improve the situation. So, in designing landscape spaces it is pertinent that equal weight is given to three aspects and pay more attention to spatial and order aspect not to increase it but to enhance it in a way so that people will get the first reading the space more. And then start to understand the other two.

The hypothesis was proved from the research that people refer landscape organization patterns in reading a space. This study can be further extended with the accompany of more spaces with a larger population sample in the Sigiriya itself.

6. References

- Bandaranayake., S. (2005). Sigiriya. City palace gardens monasteries paintings.
- Bell, S. (1993). Elements of Visual Design in the Landscape. Second Edition. London and new york: Taylor & Francis e-Library, 2005.
- Cheng, c.-k. (2007, may). Understanding visual preference for landscapes.an examination of the relationship between aesthatics and emotional bonding. 160.
- Cooray, N. (n.d.). The Sigiriya Royal Gardens, Analysis of the Land-scape Architectonic Composition, 292.
- Dictionary, C. (n.d.). Meaning of the Pattern in English Dictionary. .

- Jerpåsen, G. B., & Tveit, M. S. (2014). Safeguarding Cultural Heritage in the Urban Fringe: The Role of Legibility. *Landscape Research*, 39(4), 433–454. <https://doi.org/10.1080/01426397.2013.829808>
- Kaplan, S., & Wendt, J. S. (n.d.). *Preference AND THE VISUAL ENVIRONMENT: COMPLEXITY AND SOME Alternatives*, 5.
- Lynch, K. (2005). *The image of the city* (Nachdr.). Cambridge, Mass.: MIT PRESS.
- Staats, D. H. (n.d.). *Landscape assessment in the prairie states : design elements and landscape dimensions*, 126.

Samarawickrama, Sumanthri, et al (eds), 2018, "Sustainability for people - envisaging multi disciplinary solution": *Proceedings of the 11th International Conference of Faculty of Architecture Research Unit (FARU), University of Moratuwa, Sri Lanka, December 08, 2018 Galle* pp. 254–261. ©

MAPPING "WIND COMFORT" IN PUBLIC URBAN SPACES OF GALLE FORT, SRI LANKA

WIMALARATHNE. K.L.L¹, PERERA. N.G.R² & EMMANUEL. R³

^{1,2} Department of Architecture, University of Moratuwa, Sri Lanka

³Glasgow Caledonian University, United Kingdom

¹lahirulw@gmail.com, ²nareinperera@gmail.com, ³Rohinton.Emmanuel@gcu.ac.uk

Abstract

With a focus on public urban spaces, appropriate design could enrich the quality of urban life. These spaces should be comfortable and safe enough to invite people to stay outdoors, unhindered by numerous impacts of the microclimate, like excess wind. This research maps the influence of local wind behaviour on the users in public spaces of Galle Fort, Sri Lanka - a UNESCO World Heritage Site. The microclimatic context of the Galle Fort is modelled by means of computational simulation utilising the software ENVI-met, with a focus on generating data on dominant wind velocities and wind directions in the study area. Selected urban plots are mapped to identify; discomfort zones created by wind velocities exceeding threshold values. The study is limited to selected simple activity typologies and utilise the thermal comfort indices Predicted Mean Vote to communicate results. The results show that uncomfortable velocities occur at building corners, streets, squares and on the Fort rampart, high enough to disturb activities associated with the sitting position in the South, Southwest, and West wind directions. Conclusions draw on the need for wind assessment in public spaces for comfort and the importance of establishing a holistic approach towards the wind comfort environment.

Keywords: *Wind Comfort, Wind Mapping, Microclimate, ENVI-met, Galle Fort*

1. Introduction

"...Public spaces are the primary site of public culture; they are a window into the city's soul" Zukin, (1995)

Public spaces enrich social contact between the city inhabitants by accommodating various recreational or cultural related activities. Successful public spaces are not merely transitional spaces to walk through. They should invite people to slow down from their daily routines, contemplate and experience the place. This almost completely depends on the design of the public space in terms of aesthetics, accessibility, comfort, safety and diversity. "Urban design determines the quality of urban life that is related to physical and climatic ambiance but also to social aspects." (Szucs, 2013).

In an accelerated development and urban growth scenario, the need is to encourage more people to use outdoor public spaces frequently. Signifying a change in planning attitude, Sri Lanka's development plans suggest more recreational urban spaces to promote social contact and good-will, thus, uplifting quality of urban life, while fulfilling cultural and economic, goals and objectives. The question arises if these spaces are adequately comfortable and thus conducive as places for staying, by design.

Outdoor thermal comfort is a key contributor for successful urban public spaces. The urban morphology of the built environment around public spaces has a direct influence on the microclimate. Of the parameters that drive the level of thermal comfort, wind - expressed as wind direction and wind velocity - is a crucial component. The study is a research initiative focused on the investigation of the wind environment, and therefore 'wind comfort', in urban public spaces.

Galle Fort - a UNESCO world heritage site - a vibrant, living city that has become a 'need to visit' destination for any overseas traveller to the island, is selected. With its Dutch Colonial architecture and grid patterned streets, The Fort encompasses several public spaces which are worth of study and important to the overall ambience of setting.

Galle Fort is undergoing tremendous transformation mainly due to growth of the tourism industry, although regulation dictates that 35% of any development has to be maintained as residential. The main

element that drives the Galle's climate is generally the proximity to the Indian Ocean. The intensification of the wind velocities is common near the coast, therefore it is evident that an in-depth understanding of the wind characteristics of the Galle Fort is essential for design interventions facilitating outdoor urban living.

The primary objective of the study is to map the characteristics of the wind environment in relation to



Figure 29: Activity mapping of Galle Fort and key Public Spaces identified

the urban built fabric of the Galle Fort, with a particular focus on the public spaces. A computer simulation based research methodology is adopted to generate isocontour maps signifying thermal comfort and wind velocity. The analysis of these maps will discuss the quality of selected urban public spaces identified by the mapping, in relation to the built morphology and wind environment, for three simulation cases of varying wind directions. The primary outcome of the mapping is envisioned to generate a discussion on the 'wind comfort' - for specific tasks - of these public spaces.

The scope of study is limited to three identified wind directions prevalent in the context and the simulation is conducted for one particular day in June 2017, given the limitations of the software. The use of public spaces in the Fort is limited to the day time, therefore, the findings discussed are for the day time hours only.

2. Background

2.1 THE CONCEPT OF COMFORT

2.1.1 Wind Comfort

Gandemer (1978) describes that the changing behaviour of the wind and wind speed considerably effects the human body which occupies a space. The effects are divided into two main factors;

- The physical comfort of human body-referred to the forces induced by the variation of the wind with time and space, mechanically enforced on a human body, as an obstacle disturbing his or her performing activity.(e.g. -hindering movements or disarranging clothing / hair)
- Thermal comfort of the human body - disturbance on the physiological heat exchange between the human body and the ambient space.

Acceptable wind comfort around and between buildings plays a prominent role. In general, the term, "wind comfort" questions the life quality in the public urban spaces. The assessment should focus on utilisation of the public spaces or building with, how the urban planning serves in respect to the wind comfort which people will experience. Most of these assessments done in the outdoor urban situations covered the people's experiences while performing their most frequent activities. . (Koss, 2006)

Following this concept, the American Society of Civil Engineers (ASCE, 2003) describes these effects as mechanical direct effect of the wind force and thermal and indirect effects of thermal perception in combination with other climatic parameters. These two concepts will always be subjective to each. Conditions such as the type of activity, the climatic season, metrological conditions, and condition of the user - physically and / or mentally. All these aspects need to consider when assessment. (Table 1)

Activity	:	Comfortable ranges (m/s)
Sitting	:	0 to 2.6
Standing	:	0 to 3.9
Walking	:	0 to 5.4
Uncomfortable for any activity	:	> than 5.4m/s

2.1.2 Thermal Comfort

For this study, the Predicted Mean Vote (PMV) model by Fanger in (1972) is adopted. Developed as a heat-balance model for the calculation of the (PMV) Predicted Mean Vote, which become a frame work for the establishing indoor thermal comfort. It is seen as most suitable for simple radiation conditions. Later, developed for the outdoor complex outdoor radiation conditions by Jendritzky et al. (1979, 1990). The PMV value is used to quantify the degree of discomfort to evaluate the predicted mean vote of a large quantity of people according to the scale below. (see Table 2)

-3.5	Very Cold	Extreme cold stress
-2.5	Cold	Strong cold stress
-1.5	cool	Moderate cold stress
-0.5	Slightly cool	Slight cold stress
0	Comfortable	No thermal stress
+0.5	Slightly warm	Slight heat stress
+1.5	Warm	Moderate heat stress
+2.5	Hot	Strong heat stress
+3.5	Very hot	Extreme heat stress

Matzarakis and Mayer (1997) used this model for developing PMV maps according to the annual and monthly averages in Greece to identify the period of strong heat stress exists. The study discussed fluctuating thermal conditions at individual case studies by using calculating PMV for selected grid area. Mapping PMV Provides comprehensive information of Bioclimatic heat stress on urban spaces. Also, the spatial distribution of PMV gives clear indication the thermal discomfort or comfort with respect the morphology of the existing urban context.

2.2 WIND FLOW AROUND BUILDINGS -

Wind flow regime presented by Oke, (1978, 1987) (Figure 2) state, wind characteristics between buildings change according to the geometry of the building array. Three types were identified; Wind flow is isolated when the spaces between buildings becomes wide; Flow interacts with wake circulation stream at intermediate spacing on the canyon; Flow interacts with skimming effect when the space becomes closer to each other.

Flow patterns show, (Figure 2) how the faster moving air at the top of the buildings deflects down to the ground. This phenomenon could create complex wind circulation in-between the building spaces, especially in building canyons.

2.2.1 Thermal Effects between buildings at pedestrian level

Wind contributes to define thermal condition of the microclimate near buildings at pedestrian levels. Thermal effects between buildings are influenced by the wind flow characteristics as follows (Offerle et al., 2007);

Warming at the leeward face of the building. - Due to the vortex created, the wake effect warms the leeward face, the air can also gain heat due to the buoyancy. More ejection of the canyon air could create more warming effects near the leeward wall.

Warming at the windward face of the building. - In this case the buoyance flow could divided in to two rotating vertexes. Offerle et al., (2007) shows that when the windward face warms up, heat fluxes are enhanced, due to the buoyancy with vortex circulation. Warm air flow from the roof level could change the thermal conditions of the area near the windward face of the building.

Warming at the surface between buildings - in this case the buoyance flow divides, similar to preceding case, but advection vertex circulates close to the top of the building because of the buoyancy. The heat effects between buildings are not only subjective to the wind, but also other conditions such as solar radiation, building energy exchange between indoor and outdoor, and anthropogenic heat fluxes.

3. Method

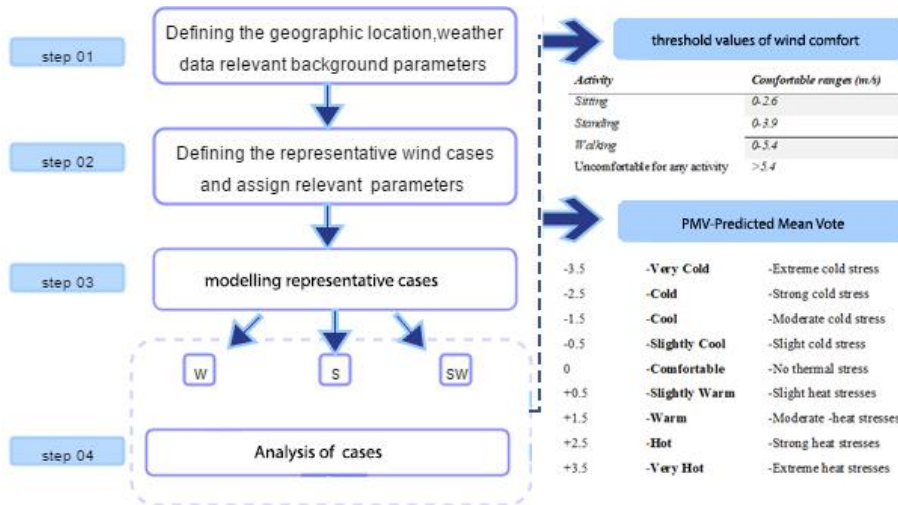

Figure 3: Research Design

Figure 3 defines the research design adopted. As detailed the study is conducted in four distinct steps, each establishing the data for the next.

3.1 STEP 01 - DEFINING THE GEOGRAPHIC LOCATION, URBAN MORPHOLOGY AND WEATHER DATA

Weather Data - The primary objective is to establish the climatic and wind context of Galle Fort. Data collected from the Meteorological Weather Station within the Fort is utilised, for a period spanning from 1993 to 2016.

On site Survey - A field survey carried out at the context established activity patterns together with the types of activity the users of the public space engaged in. These form the activity types - sitting, standing, walking - the ultimate analysis would adopt to in the determination of wind comfort. Detailed maps and on-site verification established the morphological metadata of the urban context.

3.2 STEP 02 - DEFINING THE REPRESENTATIVE WIND CASES AND ASSIGN RELEVANT PARAMETERS

This step is used to analyse and synthesise the collected data and formulate simulation scenarios. The data was collated to establish mean velocities and percentage of frequency for the primary wind

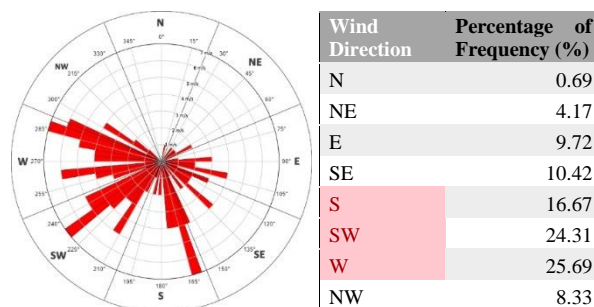

Figure 4: Wind Rose for Galle Fort with the percentage of frequency in terms of direction (see Figure 4.). The data shows Wind Speed in 10 m above ground, the mean wind velocities

recorded the highest values in June, May, July months. However, the month of May is chosen as the focus for the study, given the corresponding field work period for the study. Thus, a mean wind velocity 5.64m/s is established, at 10m above ground as standard for the comparative simulations. Further, as shown in Figure 4 three main wind directions (as a study limitation) are taken as comparative simulation cases. The cases encompass the wind directions S, SW, and W.

3.3 STEP 03 - MODELLING REPRESENTATIVE CASES

The computer simulation software ENVI-met 4.0 is utilised to model the defined scenarios. ENVI-met is “able to simulate microscale interactions between urban surfaces, vegetation and the atmosphere. It allows analysing and apprehending the impact of small scale changes in urban design and landscape (for example: tree plantation, insertion of new buildings, replacement of mineral surfaces by vegetal ones etc.) on the microclimate (Bruse and Fler, 1998). According to the available scientific literature, ENVI-met gives an adequate estimation of wind velocity, compared to observation and can be regarded as a valid tool for studying tendencies in airflow characteristics” (De Maerschalc et al., 2010).

3.4 STEP 04 - ANALYSIS OF CASES

The Analysis protocol utilises the ENVI-met extension LEONARDO 2014 for presentation and visualization of the simulated data in graphs and isocontour maps. A critical focus of the study is wind comfort, therefore analysis protocol adopts the standards defined by the ASCE for simple activities and corresponding threshold wind velocities for wind comfort. (see Table 1)

4. Results and Analysis

Results and analysis encompass two identified public spaces based on the activity zone mapping. (see Figure 1). The data presented is for wind and thermal comfort characteristics at heights 1.5m, 3.5m, and 4.5m - to ascertain the effect of the Fort Rampart - and within a time period between 9.00am and 10.00am, June 2017. The isocontour maps generated by the simulation demonstrate the wind velocity changes within the urban fabric for South, Southwest and West wind directions, and at the heights defined, (see Figure 5, 6), while Figure 7 shows the Predicted Mean Vote (PMV) differences experienced.

4.1 URBAN FABRIC MORPHOLOGY AND WIND VELOCITY

Site A - Analysis clearly demonstrates the wind shadow effect of the Fort Rampart (the Rampart is 2.5m

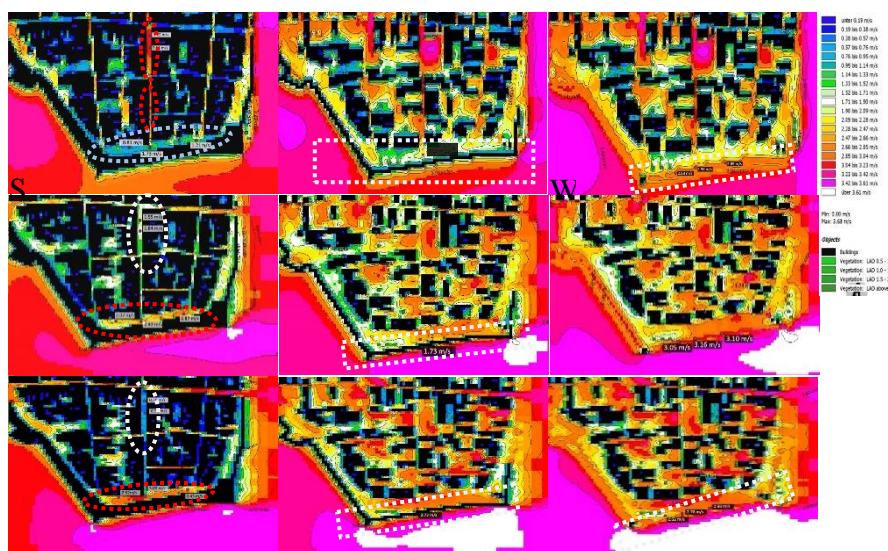

Figure 5: Site A - Wind velocity at 1.5m, 3.5m, and 4.5m for S, SW, and W wind directions

high from street level), where at 1.5m level the adjacent Rampart Road shows relatively low wind velocities, for all wind directions. This effect is negated once the analysis turns to the higher levels. The

Church Road is significant - especially when the wind is from the South. The perpendicular street to the Rampart measures a distinctively high velocity at 1.5m level, although not at the higher levels.

The Southwest and West directional winds paint a different picture, where the effect of the Rampart is not as significant and the overall patterns of velocity is enhanced throughout. Yet, the effect along Church Street remains distinct.

At the Rampart level, with the relatively undisturbed wind flow from the wind directions, created a highly ventilated zone.

Site B - In this zone two significant spaces in relation to the wind environment are highlighted. The Court Square, is an easily recognisable and prominent public space in the Fort. (Receptor points L and K). The effect of street orientation on the wind velocity is clearly demonstrated by the relative intensity of the South case. With a street pattern that runs North-South and East-West, culminate at the square, with well-defined edges, creating significant impact in wind velocity. Although diminished, in the two

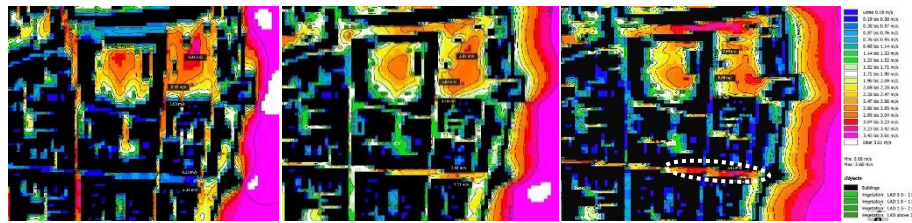

Figure 6: Site B - Wind velocity at 1.5m - S, SW, and W (from left to right)

other cases, the square remains significant because of the wind paths the streets create. The two open spaces with large trees, fed by narrow streets enhance these possibilities.

4.2 THERMAL COMFORT AND WIND VELOCITY

The PMV in urban public spaces that were identified in the wind velocity mapping is depicted as graphs. The graphs shown in Figure 7 demonstrate the PMV changes in the day time hours and compare for the changing wind directions. For all cases the environment is seen to be warm, albeit in varying degrees. On the Rampart (Receptor Point G), a key public space, the changing wind has little or no effect on comfort. This is as opposed to Receptor point A immediately adjacent to the rampart. The wind shadow seen in the velocity mapping is evident with the thermal comfort values being warmer for the South wind direction. The clear correlation between wind velocity and thermal comfort is again demonstrated in the case of receptor point D, where and increased velocity is depicted as more thermally comfortable. At the Court Square with little variation of velocity with changing wind directions, the thermal comfort readings remains unvaried.

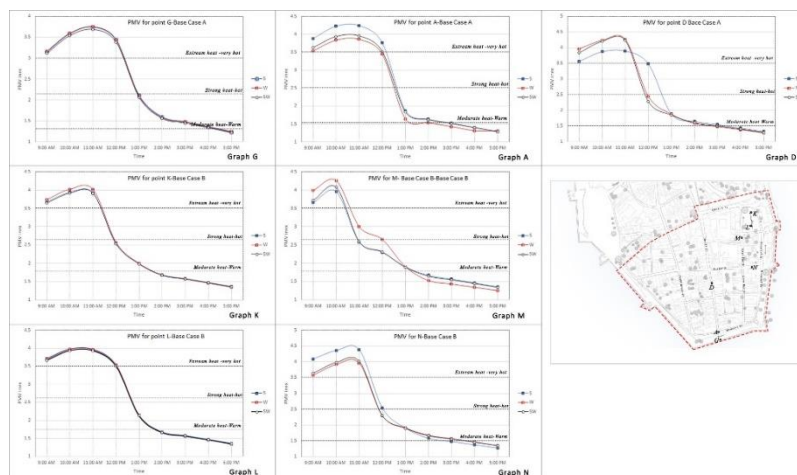

Figure 7: PMV graphs for Site A and Site B

4.3 WIND COMFORT AND WIND VELOCITY

Table 3. Wind Comfort evaluation for Simple Activity Types

Location	Wind cases								
	(S) Wind case			(SW) Wind case			(W) Wind case		
	Sitting (0-2.6 m/s)	Standing (0-3.9m/s)	Walking (0.5.4 m/s)	Sitting (0-2.6 m/s)	Standing (0-3.9m/s)	Walking (0.5.4 m/s)	Sitting (0-2.6 m/s)	Standing (0-3.9m/s)	Walking (0.5.4 m/s)
Rampart St. z=1.5m	✓	✓	✓	X	✓	✓	X	✓	✓
Rampart St. z=1.5m	✓	✓	✓	✓	✓	✓	X	✓	✓
Rampart St. z=1.5m	✓	✓	✓	X	✓	✓	✓	✓	✓
Church St.z=1.5m	X	✓	✓	✓	✓	✓	✓	✓	✓
Church St.z=1.5m	X	✓	✓	✓	✓	✓	✓	✓	✓
Rampart intermediate level z=3.5m	✓	✓	✓	✓	✓	✓	✓	✓	✓
Rampart Top level z=4.5m	X	✓	✓	X	✓	✓	X	✓	✓
Rampart Top level z=4.5m	X	✓	✓	X	✓	✓	X	✓	✓
Rampart Top level z=4.5m	X	✓	✓	X	✓	✓	X	✓	✓
Low court square z=1.5m	X	✓	✓	X	✓	✓	X	✓	✓
Low court square, middle z=1.5m	✓	✓	✓	X	✓	✓	X	✓	✓
Leyn baan St. z=1.5m	X	✓	✓	✓	✓	✓	✓	✓	✓
Pedler st. z=1.5m	✓	✓	✓	X	✓	✓	X	✓	✓
hospital st.intersection z=1.5m	✓	✓	✓	✓	✓	✓	X	✓	✓

Wind comfort for the selected receptor points are evaluated for specified activities in an urban space. Table 4 details out the level of comfort (✓ - comfortable; X - not comfortable) based on the threshold values defined in literature.

For all wind cases and sites, the wind environment is conducive for ‘Standing’ and ‘Walking’. It is only in the analysis for ‘Sitting’ that a negative impact is seen. At the Rampart level with enhanced wind velocities, the activity of sitting is found to be uncomfortable.

At the Court Square a similar pattern is seen, where, with the enhanced wind velocity, the spaces are deemed to lack wind comfort. The direction of the wind make a slight impact in the spaces around the main public spaces discussed, yet are consistently uncomfortable for sitting in this particular day in June, 2017.

5. Conclusion

The research was designed to evaluate the impact of wind velocity and wind direction on making urban public spaces comfortable. A prominent and successful destination in Sri Lanka’s context - the Galle Fort - a setting that can truly defined as urban was selected. The primary means of mapping the wind impact was in utilisation of a computer simulation software ENVI-met.

Analysis of results were discussed as three interconnected lines of thinking encompassing the relationship between - Urban Fabric Morphology and wind velocity; Thermal Comfort and wind velocity; Wind Comfort and wind velocity.

5.1 FINDINGS AND IMPLICATIONS FOR DESIGN

The findings confirm current knowledge on the impacts of the urban morphology on the wind environment, especially in terms of orientation of streets, open space creation with well-defined physical envelopes and impacts of significant barriers to the wind flow. The North-South, East-West, grid of streets are significant in the Fort in its positive contribution to the wind penetration into the more internal zones of the fabric, thus creating possibilities for open space creation that are still well ventilated.

The impact of a change in canyon geometry is clear in the two prominent areas highlighted in the study - the Court Square and Church Street - where wind paths along the streets in both direction are collected into spaces that have a significant physical envelope, that hinder through flow, yet create enhanced wind velocity within the space. The challenge here is ensure the wind paths continue on, albeit in altered direction such that downwind areas are not deprived of its advantage. Further, the increased velocity in these spaces boarder on discomfort in terms of ‘wind comfort’ for specific tasks such as sitting. Design of the edges of these spaces are crucial in this sense where adequate, and sheltered places for sitting

can be created. Elements such as arcades and verandahs, tree places, level changes in the floor plane, vegetation barriers, can be utilised to temper the wind environment. Within space zoning is encouraged, such that a variation created and options given for the varying activities.

The average wind velocity was established as 5.64ms^{-1} for the simulation study based on meteorological data of over twenty years. The upper threshold value for walking is stated as 5.4ms^{-1} , yet the maximum velocities border on 3.6ms^{-1} , thus highlighting the possibility of wind comfort even at higher velocities. This also impacts the thermal comfort, where the spaces evaluated are shown as uncomfortable, although the relationship to higher velocity for higher thermal comfort levels are clear. Thus, other measures such as solar radiation impact reduction within public spaces are essential. The streets are relatively sheltered and in shadow because of the low aspect ratios of the fabric, yet the creation of shade is important in the open areas as well. Overhead planes, tree places, shade structures can be useful to mitigate, while ensuring wind flow.

5.2 LIMITATIONS AND DIRECTIONS FOR FUTURE STUDY

Galle Fort continues to house important public spaces that are extensively used. The study limits its scope to a single day in June, 2018. Thus, an evaluation of the wind environment of the Fort for critical times in a year is deemed essential for policy and design. This will also facilitate the development potentials, and therefore restrictions needed to ensure overall thermal and wind comfort of the environment. The limitations of the software does not account for the nature of the street canyon and open space edges, which can impact the wind velocity. A more detailed study of the areas highlighted in the wind mapping is encouraged.

Morphology changes, albeit in terms of building height, built surface and vegetation - have significant impact in any urban environment. Therefore, urban fabric modification for future development enhancement and overall comfort in the environment is deemed important.

5.3 SUMMARY

The study presents a research flow that encompasses mapping to understand the urban environment, thus identify critical zones in the fabric and ascertain the needs and thus generate possibilities for design intervention for enhancement. This protocol can be easily replicated and built upon to ultimately generate an 'informed' decision making process, ensuring the continued and enhanced sustainability of the UNESCO World Heritage Site, Galle Fort, Sri Lanka.

6. References

- ASCE. (2003). *Outdoor Human Comfort and Its Assessment*. USA: ASCE Publications
- Bruse M, Fleer H. Simulating surface-plant-air interactions inside urban environments with a three dimensional numerical model. *Environ Model Softw* 1998; 13:373-84. Doi: 10.1016/S1364-8152(98)00042-5.
- De Maerschalk, B., Maiheu, B., Janssen, S., Vankerkom, J., 2010. CFD-Modelling of Complex Plant-Atmosphere Interactions: Direct and Indirect Effects on Local Turbulence. CLIMAQS Workshop 'Local Air Quality and its Interactions with Vegetation' 2010, Antwerp, Belgium
- Fanger, P. O. (1973). *Assessment of man's thermal comfort in practice*. British Journal of Szucs, A. (2013). *Wind comfort in a public urban space*. Higher Education Press Limited Company, 51-52
- Gandemer. J. (1978). National Bureau of Standards Technical Note 710-98. In *Building Research Translation: Discomfort Due to Wind Near buildings Aerodynamic concepts* (p. 48). Washington: US Government Print Office.
- Jendritzky G, Sönning W, Swantes H J (1979) *Ein objektives Bewertungsverfahren zur Beschreibung des thermischen Milieus in der Stadt- und Landschaftsplanung ("Klima Michel-Modell")*. *Beiträge Akad. Raumforschung Landesplanung*, 28, Hannover
- Koss H.H. (2006). On Differences and similarities of applied wind comfort criteria. *Journal of wind Engineering and Industrial Aerodynamics* 94, 781-797. *Industrial Medicine*, 313-324.
- Matzarakis A, Mayer H (1997) Heat stress in Greece. *Int. J. Biometeorol.* 41: 34-39
- Offerle B, Eliasson I, Grimmond C. S. B, Holmer B. (2007). *Surface heating in relation to air temperature, wind and turbulence in an urban street canyon*. *Boundary-Layer Meteorol*, 273-292
- Oke, T. (1978, 1987). *Boundary layer climates.*—2nd ed. In T. Oke, chapter 8- *Inadvertent climate modification* (pp. 262-303). *Taylor & Francis e-Library*.
- Zukin, S. (1995). *The Cultures of Cities*. Cambridge, MA: Wiley-Blackwell

Samarawickrama, Sumanthri, et al (eds), 2018, "Sustainability for people - envisaging multi disciplinary solution": *Proceedings of the 11th International Conference of Faculty of Architecture Research Unit (FARU), University of Moratuwa, Sri Lanka, December 08, 2018* Galle pp. 262–270. ©

ENVISIONING GRAVEYARDS IN DENSE URBAN AREAS IN CONTEXT OF DHAKA CITY *From preserved hallowed ground towards healing landscape for the community.*

SIKDER S.P.¹ & ALAM F².

¹VITTI Sthapati Brindo LTD, Dhaka, Bangladesh

²Bangladesh University of Engineering and Technology, Dhaka, Bangladesh

¹shauni.29arch.buet@gmail.com, ²ar.fahimalam@gmail.com

Abstract

Graveyards or burial grounds are an integral component of civic and community life of any city. They comprise a key religious, cultural and social element with a long history that has played a vital role in constantly changing and evolving society. Administrators and planners of densely packed megacities like Dhaka often find it difficult to spare enough land for burials and have to operate with scarcity of open green space within urban areas. Nevertheless, city graveyards can be transformed from just places for the deceased to urban oases of healing, commemoration and even the celebration of city-life. Henceforth, the graveyards in Azimpur, one of the oldest residential areas, has been taken as study area. This research was principally based on observation and field survey. Books, journals, documents from websites etc. are the sources of secondary data. The main objective of this study is to explore the existing condition of graveyards of urban residential areas in Dhaka city, to look into why civic and environmental interactions with graveyards are missing and also to identify their potential as healing gardens and open neighborhood space. It is clearly stated that, visual and physical connection with graveyards create positive environmental scopes for both neighborhood and as well as commuters.

Keywords: *Graveyard; Urban area; Residential area; Public space; Healing Landscape*

1. Introduction

"Whatever the cause, one consequence is clear; the place where we bury our dead are no longer important parts of the landscape we inhabit"
(Howett 9) – Catherine Howett

Graveyard is a sacred and symbolic representation of living community that reflects cultural beliefs and values of a community, both past and present. Graveyards or burial grounds, have always been a part of the human environment and as well as urban community.

Dhaka, being the capital and most important city of Bangladesh, is developing rapidly without any thoughtful planning. Most of the developments are quantitative, rather than qualitative. Due to rapid increase of population in last few decades, many planned and unplanned structural developments happened in Dhaka city to accommodate such a huge population. But enough open outdoor community space or urban spaces are not being created to provide recreational facilities for the growing population.

In terms of landscape architecture, graveyards in high density urban areas are worth discussing as they could offer alternative recreational areas to the community. As on-going high-density construction developments are built around graveyards, a graveyard loses its accessibility, permeability, visibility and degree of openness. But the graveyards can be used as an open space to accommodate activities like walking, bird watching and they can provide an area for urban forest or a visual release within dense concrete jungle. Ideally a graveyard should be a landscape that is more than a burial place for the dead but a place in which the need for remembrance and healing is addressed. A proper landscape treatment of graveyards has a significant impact on outdoor public environments that create an efficacious city environment. The main objective of this study, is to explore the existing situations of graveyards in residential areas in Dhaka city and also to identify its impact on their surrounding environment. Furthermore, this study aims to evaluate potential uses of graveyards in high-density urban environments and explore further potential uses of graveyards.

2. Literature Review

Historically graveyards were considered as hallowed ground where community members would gather to commemorate and recall the loss of their close ones. In the communal sense, death was once seen as an “occasion for solemn celebration” (Sloane 50). “The cemetery, by definition a place of memories, became a location for the memory of the community” (Sloane 80). Sloane (1995) indicates that when community lacks a close connection with such cemeteries, the cemetery loses its cultural significance.

The public perceives cemeteries as both a blessing and a curse (Basmajian and Coutts 2010). People in the surrounding city put sentimental feelings on the place because it is associated with historical, religious or mythical events that contribute to the culture of its community. Cemeteries become a visual reminders of mortality, alter the view shed, and produce increased traffic and noise (Basmajian and Coutts 2010). Cemeteries also provide valuable open spaces and visual release, especially in dense urban neighborhoods (Basmajian and Coutts 2010)

Graveyard design evolves from the city pattern itself and creates a connection between dead and the living. “The grid pattern, prototype for almost all city, town and farm layouts... became the dominant layout in cemeteries until very recent times, the “streets” becoming walkways, the “blocks” containing several grave plots.” (Francaviglia, 1971, p.505).

Project for Public Spaces described four key qualities of a successful public spaces, which are; accessibility, participation of people in different activities, comfortable environment and a good sociable place for mass people (Heffernan, 2014).

High demand for green infrastructure and open space in urban area, as part of social and green infrastructure systems, the most important thing is to ensure that all urban cemeteries are accessible to the public (Afla and Reza 2012).

In 1997 the Portland Audubon society published a short article, “Cemeteries as Greenspaces” in *The Urban Naturalist* (Rogers 1997). According to Rogers (1997), “Virtually all remaining open spaces, including cemeteries, will increase in value to local neighborhood and to the region. Cemeteries, especially ones owned by Metro’s Regional Parks and Greenspaces, should be managed in a way that provides multiple values, including wildlife habitat, to the community around them.”

3. Public Graveyards in context of Dhaka City:

A public graveyard is one that is used by the general community or a neighborhood. Dhaka, one of the fastest growing megacities in the world, is facing rapid urbanization with increasing infrastructures and high population mobility. Here, Urbanization can be defined as the social process whereby concentration of human settlements results in the expansion of an area into less inhabited or natural land (AMM Quamruzzaman).

Before 1882, there was no public graveyard in Dhaka city but there were several private or family graveyards. In 1882, the family graveyard of Purana Paltan was turned into a public graveyard by the authority of Dhaka Municipality. After the liberation war in 1990, Dhaka Municipality was renamed Dhaka City Corporation. At present there are four public graveyards under Dhaka City Corporation Authority. Among them Azimpur public graveyard is the oldest and largest of all. It covers 23 acres of land. The second and third largest public graveyards are at Mirpur and Jurain, consisting of 18 acres and of 14 acres of land respectively. Another public graveyard in Dhaka is situated at Banani covering 11 acres of land.

In Dhaka, graveyards can no longer be only a hallowed space to be visited for mournful occasions. It must be an integral part of urban open spaces.

4. Methodology:

This is a generalized study and it is expected that the outcome of this study would be applicable in the context of Dhaka city. The public graveyards of residential area around ‘Azimpur’ have been selected for this study. As one of the largest and oldest public graveyards “Azimpur Public Graveyard” is located within this residential area which is divided into two graveyards as Azimpur new and Azimpur old graveyard. Also another significant graveyard is located within this residential area known as Azimpur Iraqi Graveyard. Our study is focused on the prevailing conditions of these three graveyards.

The overall study has been conducted in several phases. The primary data have been collected through visual observations, photographs, field survey, sketches and field notes. Secondary data on graveyards and related aspects have been gathered through literature study. Then computer aided drawings based on GIS map and field survey have been prepared. Then the existing physical features and their relations with surrounding areas of three graveyards were analyzed. Finally, the analysis phase aimed to evaluate potential uses of graveyards in high-density urban environments.

5. Background of the Study Area:

Azimpur is an old region in the old part of Dhaka and the region is named after Shahzada Azam, son of Mughal Emperor Aurangzeb. Azimpur is one of the oldest residential areas in Dhaka. The Azimpur graveyard was established on 23 acres of land in 1850. (AMM Quamruzzaman, 2009).

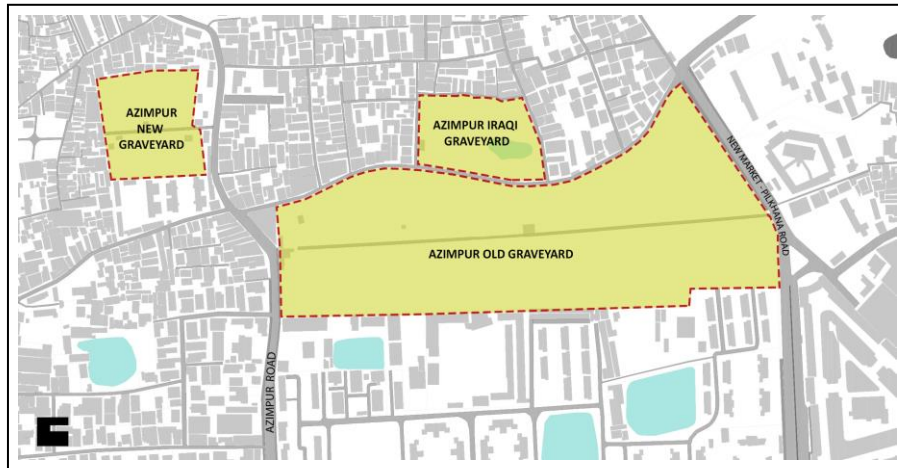

Figure 1: Azimpur residential area and graveyards (Source: GIS map)

The old part contains the mazars of Sufi Mohammad Daem, Shah Raushan Ali and Karim Shah. Sufi Mohammad Daem built a mosque here in 1769. He and other Sufis were buried near the mosque after their death. The burial place was gradually extended to form the present Azimpur old graveyard. The new part of Azimpur graveyard was a small fish market which was later occupied by the municipal authority to expand the burial ground (AMM Quamruzzaman, 2009).

At New Paltan Line in Azimpur, there is an Iraqi Shiah graveyard, property of the Iraqi Association in Dhaka. The ethnic community long ago migrated from Iraq and used to bury the dead in this graveyard. It was established in 1950 (AMM Quamruzzaman, 2009).

6. Analysis and Outcomes:

Azimpur was once one of the oldest planned residential areas. Now it has become very dense. Three graveyards are very important potential urban open space for the area.

Table 1: Selection and Present Condition of Graveyards

	Azimpur Old Graveyard	Azimpur New Graveyard	Azimpur Iraqi Graveyard
Establishment Time	1850	1965	1950
Area	45 Acres (Dr. Nilufar, 2000)	3.7 Acres (Dr. Nilufar, 2000)	3.03 Acres with playground
Management	Dhaka City Corporation	Dhaka City Corporation	Iraqi Association
Present condition	Active	Active	Active
Security	Secured graveyard, presence of adjacent boundary wall (7-8feet) high, accessible	Highly secured graveyard, presence of adjacent	Less secured graveyard, adjacent boundary wall is absent,

	through two gateways only	boundary wall (10-12feet) high, accessible through one gateways only	Accessible from all sides.
Mosque	The graveyard was evolved from establishment of a mosque in 1769 by Sufi Mohammad Daem. The mosque is recently redesigned for the community	There is no mosque inside the graveyard.	There is no mosque inside the graveyard, but a community building for Iraqi association is located beside graveyard.
Mausoleum	Present	Present	Absent
Landmarks	Present	Absent	Absent
Typology	Public graveyard, with both reserved and reusable graves.	Public graveyard, but most of the graves are reserved and permanent.	Ethnic community graveyard, with both reserved and reusable graves.

6.1 PERIMETER BOUNDARY WALLS AND ITS IMPACT ON SURROUNDING:

In Dhaka, most of the public graveyards are surrounded by a high wall (7-10 feet high) that separates the graveyards from public footpath and roads for privacy and protection, having a little visual connection with surroundings. But physical and visual connection between graveyards and surrounding neighborhood plays a significant role for experiencing better urban features.

Both Azimpur old and new graveyards have solid boundary wall along the edge of street, which are generally constructed for privacy and security. However, it is observed that, these perimeter boundary wall creates obstructions for social interactions and do not assure safety and security.



Figure 2: Azimpur old, new and Iraqi graveyard (Source: Author)

Rather, it is one of the reasons of anti-social behaviors as it visually disconnects people on footpath or road from the graveyards. Besides high perimeter wall creates narrow lane effect with the adjacent secondary roads. These high walls create a sense of negativity among the neighborhood and people consider graveyards as a horror place.

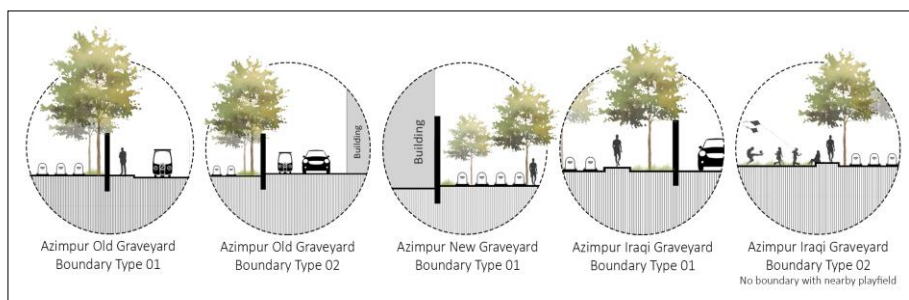

Figure 3: Different types of boundary wall around graveyard showing degree of visual connection

But in Azimpur Iraqi graveyard, there is a boundary wall only at the street side but the graveyard is accessible from other three sides. This graveyard blends into the community and has become a part of community space for the neighborhood. Public interaction is maximum in this graveyard as there is no defined perimeter wall. It is evident from the study that, the Iraqi graveyard contributes in creating a positive impact on surroundings as its edge is visually and physically permeable. Such active environment can offer safety and security for both graveyards and as well as commuters. Absence of a definite perimeter wall has successfully erased the negative effects and taboo for graveyards from people’s mind. Even children don’t fear to visit this graveyard.

6.2 ACCESSIBILITY & RELATIONSHIPS WITH ITS SURROUNDING:

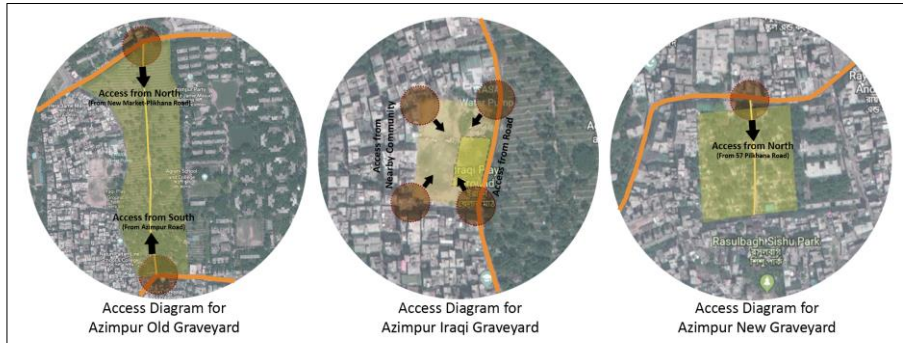

Figure 4: Accessibility diagram (Source: Google Map and Author)

Azimpur old graveyard is accessible through two gates from two primary roads, Azimpur road from south and New Market-Pilkhana road from north. Azimpur government colony is located at its east side and a secondary road connecting Azimpur and new paltan line is at its west side. Commuters can take shortcut from Azimpur to New Market through graveyard’s main pedestrian road.

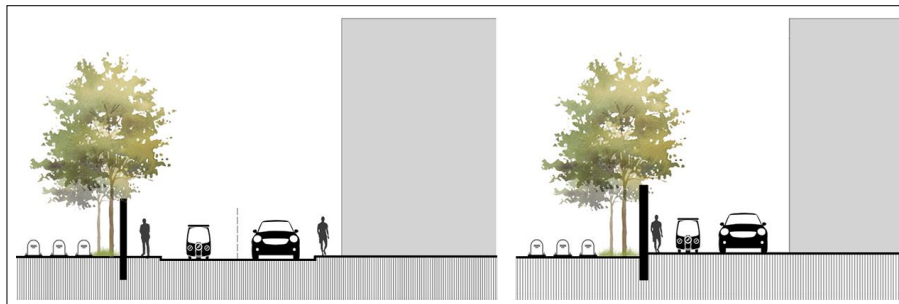

Figure 5: Relationship between Azimpur old graveyard and surrounding. (Source: Author)

Azimpur new graveyard is accessible through only one gate from a secondary road: 57 Pilkhana Road. The graveyard is surrounded with residential buildings around it.



Figure 6: Relationship between Azimpur new graveyard and surrounding. (Source: Author)

Azimpur Iraqi graveyard is accessible from three sides. Only Azimpur to New Market road is on east side separated by a boundary wall.

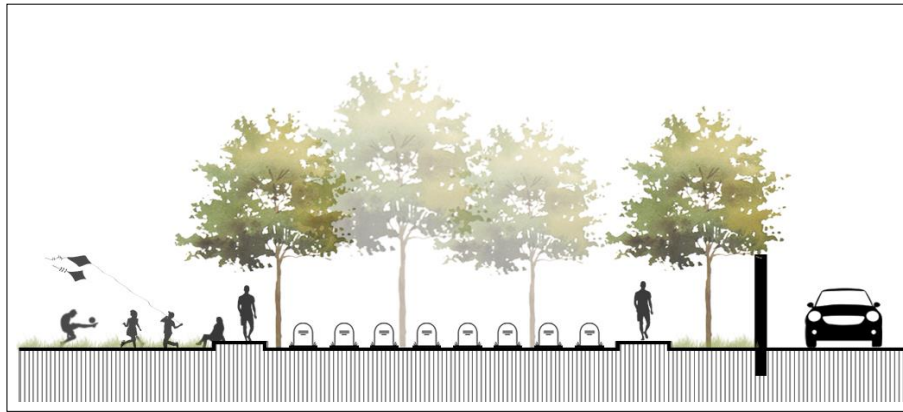

Figure 7: Relationship between Azimpur Iraqi graveyard and surrounding. (Source: Author)

6.3 Degree of Public Engagement:

Azimpur old graveyard is a symbol of historic memories that are laid within it. Since early ages of its establishment, people come to pray for the deceased. During major festivals, thousands of people gather here to pray and show love to their deceased relatives and close ones then the atmosphere becomes very sacred and solemn. The mosque inside the graveyard is used as a community mosque for Azimpur. The graveyard has public amenities like a sitting area, shading, etc. but due to poor physical and visual connection with surroundings it doesn't have any significant public engagement like walking, bird watching, resting, etc. The Azimpur new graveyard is so confined and the amount of reserved graves is so high that public engagement is very poor in this graveyard. People occasionally come here to pray for their close ones. Due to its high perimeter wall and lack of openness with surroundings, it sometimes becomes difficult to find its existence.



Figure 8: Iraqi, Azimpur old and new graveyard (Source: Internet and Author)

Azimpur Iraqi Graveyard is perhaps the most publicly intimated graveyards among these three graveyards. It is a small graveyard but its impact towards the community should be praised. People come here not only for remembering close ones who are laid here but also for walking, sitting and gossiping. There is a playground along with this graveyard and children come here to play regularly. There is a community building of Iraqi association with this graveyard where people gather in different occasions. Degree of public engagement is low due to social, cultural and religious values towards graveyards.

6.4 Existing Hardscape and Landscape:

Neither Azimpur old nor Azimpur new graveyards have peripheral walkways. There is a central spine like pathway along the north-south direction and 2ft wide secondary pathways intersect the central pathway along the east-west direction. In Azimpur Iraqi graveyard, there is a peripheral walkway that allows people to walk around the graveyard.

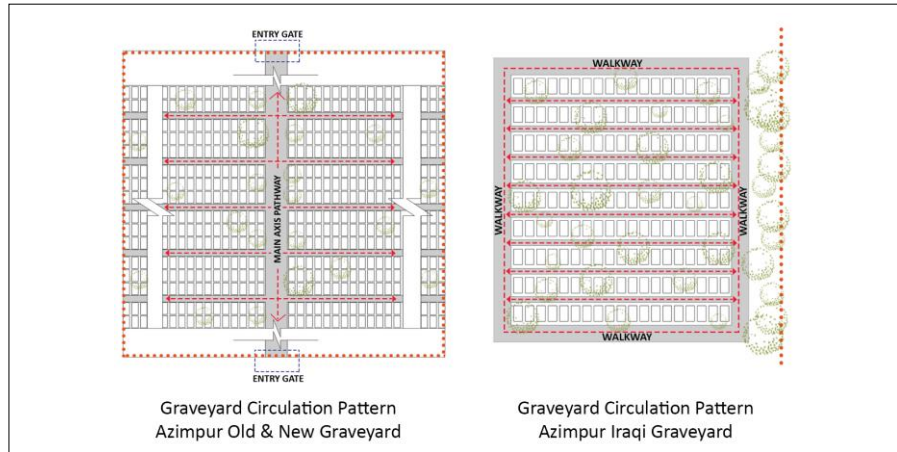

Figure 9: Existing circulation pattern and Landscape & Hardscape (Source: Author)

The secondary pathways run along the east-west direction at a fixed interval. All three graveyards in Azimpur follow grid pattern for burial arrangement. The existing landscape pattern is not well-planned and there is opportunity for rethinking the landscape. Though Islamic Shariaah doesn't allow permanent burials but most of the graveyards in Dhaka have an increasing number of reserved and permanent graves.

7. Graveyard as Healing Landscape:

Any landscape, designed or wild, that facilitates human health and well-being is known as a Healing Landscape. Landscape architect Matthew Berry examined the cemetery as a therapeutic environment and identified three key aspects of a therapeutic environment as outlined: physical environment, administrative environment and behavioral environment. Physical environment includes the objects in a setting; places such as the cemetery entrance, administrative buildings, monumental and lawn areas; natural features such as forests and lakes; relation between places created by such things as barriers, paths, vegetation, views and qualities such as setting, light, sound (Salisbury,2002,p.18).



Figure 10: Considering graveyards as healing landscape (source: Author & Internet)

Being a high-density megacity, Dhaka is facing the scarcity of open space and healthy community life for its citizens. With proper interventions, instead of degrading social and cultural values, graveyards could create more closeness with urban environment. In cities like Dhaka, graveyards and parks are now the only large green areas that remain. Graveyards can be an alternative healing landscape solution for monotonous city-life in Dhaka.

8. Proposals and Recommendations:

According to survey, most of the graveyards in Dhaka city are facing land scarcity for future burials due to increasing numbers of permanent and reserved graves. Instead of permanent burials, if natural burials are promoted, it will possess more public green space and lands can be reused. If people start planting one tree instead of building a memorial or cenotaph, graveyards will be transformed into an urban forest. Thus increasing green spaces will then improve urban climate, absorb toxic gas, reduce noise pollution, adjust human psychology and maintain biodiversity of surrounding areas.

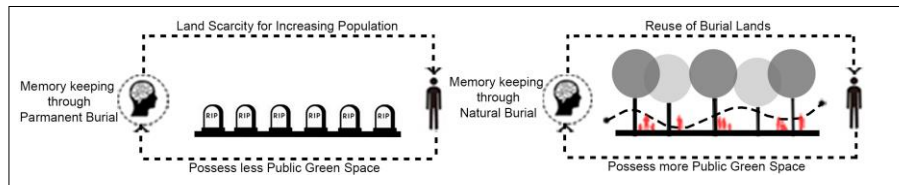

Figure 11: Diagram showing difference between permanent & natural burials. (Source: Author)

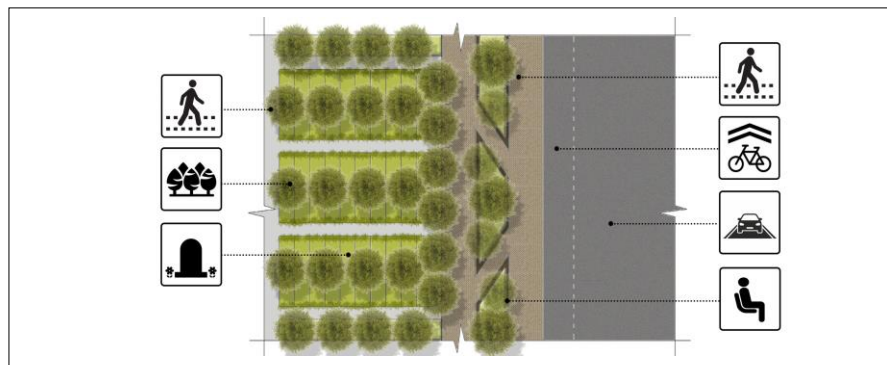

Figure 12: Desired landscape and edge treatment for graveyard . (Source: Author)

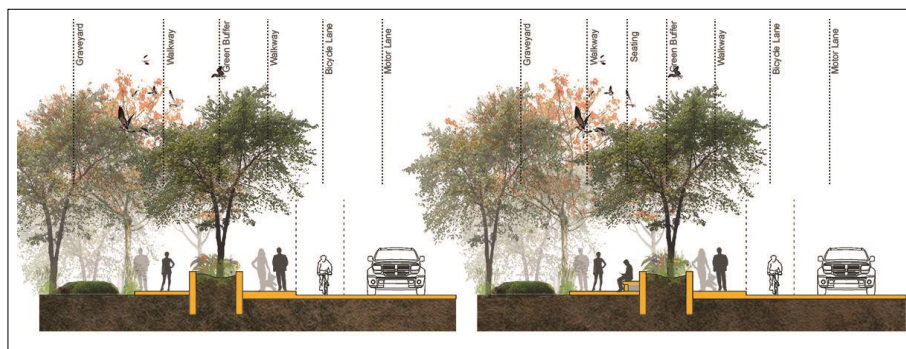

Figure 13: Desired visual connection between graveyard and its surrounding. (Source: Author)

Another important feature is graveyard edge treatment. It is evident that due to lack of visual connection with its surroundings, graveyards are not considered as a part of urban community space. Most of the people don't even imagine graveyards as urban space as they can't access the graveyards physically and visually. But Cemeteries are considered as urban space in developed countries. So it is high time to rethink the landscape, activity pattern and edge treatment of graveyards for Bangladesh. As, Graveyards are sacred spaces for Muslim community, so activity pattern and provision of public amenities should be designed considering religious values as well.

9. Suggestion for Future Research:

The overall findings of this study shows that there are opportunities for further research investigation for graveyards in Dhaka city. Here are some suggestions for future investigation,

- It is important to involve professional architects, urban planners and landscape architects with their ideas for alternative use for existing graveyards as urban spaces.
- Future planners should find out ways to increase connectivity, accessibility and visibility to graveyards.

10. References:

Howett, Catherine. (1977) "Living Landscape for the Dead." Landscape. Vol.21: 9-17.
 Sloane, David Charles, (1995). "The Last Great Necessity: Cemeteries in American History". Baltimore: The John Hopkins University Press.
 Basmajian, C. and C. Coutts (2010). "Planning for the Disposal of the Dead." Journal of the American Planning Association 76(3): 11
 Francaviglia, R. V. (1971). "The Cemetery as an Evolving Cultural Landscape." Annals of the Association of American Geographers 61(3):10

- Heffernan, E., Heffernan, T. & Pan, W. (2014). *"The Relationship between the quality of active frontages and public perceptions of public spaces."* Urban Design International, 19(1), 92-102.
- Afla, M and M. Reza (2012). *"Sustainability of Urban Cemeteries and Transformation of Malay Burial Practices in Kuala Lumpur Metropolitan Region."* World Academy of Science and Technology 71.
- AMM Quamruzzaman, (April 29, 2009). *"Graveyards and Urbanization: The case of Dhaka City"*, Sociology Graduate Student Symposium at Queen's University, Canada.
- Rogers, R. (1997). *"Cemeteries as Greenspaces."* Urban Naturalist 2 (Summer): 8.
- Salisbury, M. (2002). *"A Feasibility Study of the woodland cemetery in Canada"*. University of Guelph, Canada. Page- 18
- Dr. Nilufar, Farida, (July 2000) Unpublished Research Report on: *"Urban life and use of Public Space Study of responsive public open spaces for supporting urban life in Dhaka City."* The Asiatic Society of Bangladesh, Dhaka.
- Public vs. Private Cemeteries, <https://cemeteries.uslegal.com/public-vs-private-cemeteries/>.

Samarawickrama, Sumanthri, et al (eds), 2018, "Sustainability for people - envisaging multi disciplinary solution": *Proceedings of the 11th International Conference of Faculty of Architecture Research Unit (FARU), University of Moratuwa, Sri Lanka, December 08, 2018* Galle pp. 271–279. ©

LABOUR PRODUCTIVITY IN PLASTERING WORKS IN SRI LANKAN CONSTRUCTION INDUSTRY

PASATH. V¹, DISSARATNE. V², GANSHU P³ & N.F.Sabrina⁴

University of Moratuwa, Moratuwa, Sri Lanka

¹vprasath1990@gmail.com, ²vijitha.disaratna@gmail.com, ³Sunganesh21@gmail.com, ⁴ sabrinanazeer@gmail.com

Abstract

The prospect of labour productivity in Sri Lankan construction industry has been attaining increasing attention as the industry suffers multiple problems related to its workforce. Thus, the need of productivity improvement is essential for successful project completion. At the same time, plastering works encounter in high number of labour productivity issues in the industry, where, the wastage is comparatively high. Therefore, this study explored the correlation between factors affecting the labour productivity and the productivity in plastering work. The literature specified certain factors, which influence the productivity of the labourers within the site. Even though many factors exist in the industry, mainly twelve factors had been categorised under five main headings, such as; management factors, site and resource management factors, project characteristics factors, workforce characteristics factors and external characteristic factors. Research approach for this study was as exploratory mixed method design where a quantitative analysis was enhanced with qualitative review of survey data. The data for the research study were collected through work studies from sites and interviews with professionals in the industry. Subsequently, the analysis was done with the aid of statistical technique and content analysis technique, while, MS Excel and SPSS were the tools used for the analysis. Quantification of labour productivity was expressed in research findings with the help of work studies. The findings revealed the correlation of each factor towards the productivity of labourers in plastering works. However, some factors had positive relationship and some other factors had negative relationship. Thus, the professionals must consider the correlation in order to improve the productivity within the site. Based on the analysis, solutions were recommended in latter part of the research.

Keywords: *Affecting factors, Labour, Labour productivity, Plastering, Work-study*

1. Introduction

Importance of labour productivity in construction arises from its impact on completing projects within their targeted time and cost (Thomas, 1991). For instance, contractors have often focused on labour productivity rates as the primary source of the overall success or failure of a project (Missbauer & Hauber, 2006).

Contractors at the bidding stage of a project are interested in knowing site labour productivity figures, to estimate the labour cost component of the project. Thereafter, if the contract is awarded to the contractor, the company needs to ensure that the estimated level of productivity is achieved or improved (AbouRizk, Knowles, & Herman, 2001). Alan (1987) stated that productivity is commonly defined as a ratio of a volume measure of output to a measure of input use. Improving productivity is a major concern for any profit-oriented organization, as representing the effective and efficient conversion of resources into marketable products and determining business profitability (Wilcox, Stringfellow, Harris, & Martin, 2000).

Teo, Abdelnaser and Abdul (2009) believed that building material wastage on construction sites account for cost overruns and any improvement in building materials management on construction sites has the potential to enhance the construction industry's performance with cost saving benefits. Ameh and Itodo's (2013) research results indicated that the most wasteful building material during construction operation is mortar from plastering/rendering, since it has 40 to 70 percentage of labour involvement. Further Gihan, Ahmed, and Adel (2010) found that labour force has major role in material wastage by the way of re-work, poor material handling, poor workmanship and etc. in plastering work. This seems that labour productivity should increase in order to achieve the project success.

Lema (1995) stated that the factors influencing construction productivity have been the subject of inquiry by many researchers. In order to improve productivity, a study of the factors affecting it, whether positively or negatively, is necessary. Making use of those factors that positively affect productivity and eliminating factors that have a negative effect, will ultimately improve productivity. As there is no any studies focus on plastering productivity, this study aimed to increase labour productivity in Sri Lankan construction industry.

2. Factors Influencing Labour Productivity

It is necessary to determine, whether factors affecting labour productivity act in a positive or negative way (Enshassi, Mohamed, Mustafa, & Mayer, 2007). If all factors having an impact on productivity are identified, it will also be possible to forecast productivity (Lema, 1995).

Thomas, Skitmore, Lam, and Poon (2003) put emphasis on several predominant de-motivators affecting productivity of civil engineering projects, which are rework, overcrowded work areas, crew interfacing, tool availability, inspection delays, material availability and foreman incompetence. At the same time, Mojahed & Aghazadeh (2008) found major productivity factors which have an impact on labour productivity. The top five are skills and experience of the workforce, management, job planning, motivation, and material availability. Ovararin (2001) conducted a comprehensive review on the factors influence labour productivity on construction sites. That study resulted in his categorizing the influencing factors into seven main areas: project, management organization, site and resource management, labour and moral values, acceleration, changes and, external environment. An analytical study was done on these categories, and it was discovered that thirteen factors impart a strong influence towards labour productivity rates at construction sites in the United States of America. They are work planning and scheduling, competency of site supervisors, availability of construction materials, workforce availability, work sequence, congestion, repetition of similar work, communication failure, sub-contractor coordination, unpredictable weather conditions, access to work sites, scheduling of overtime works and, disruption to the workforce on construction sites (Rojas & Aramvareekul, 2003). According to the above mentioned factors the major categories are illustrated in below;

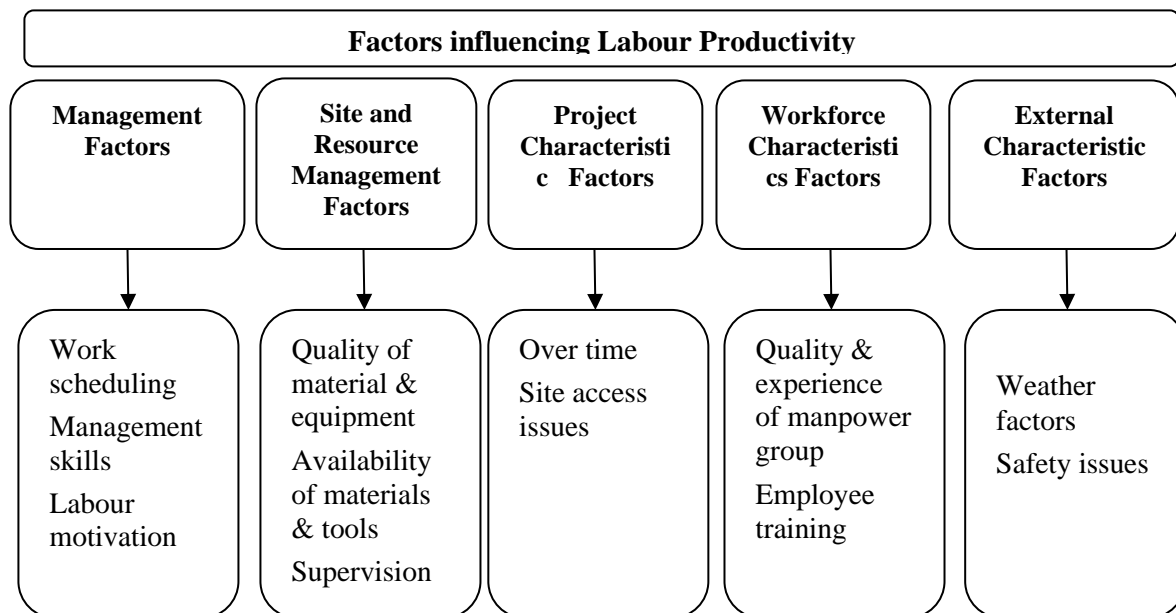

Figure 1: Factors influencing labour productivity
(Source: Rowlinson & Proctor, 1999)

3. Research Methodology

Research approach for this study was a quantitative analysis enhanced with qualitative review of survey data, where it is named as exploratory mixed method design (Creswell, 2003). According to Punch (2005) research studies generally contain a number of different research queries. Hence, a research

method appropriate for one question may be inappropriate for another. Considering in this, the procedure was to first gather quantitative data through work studies to find out the productivity of the labourers in plastering works within the Sri Lankan building construction industry. Then qualitative review would be prepared based on the above findings. The review would be conducted from professionals through semi structured interviews to find solutions to increase productivity of Labourers in plastering works.

3.1 DATA COLLECTION TECHNIQUES

The technique used in this research is observation. The data collection process of this particular research comprised of two main components; work study and the semi structured interviews.

3.2 WORK STUDY

Work study is a systematic examination of the methods carrying out activities such as to improve the effective use of sources and to set up standards of performance for the activities carried out. Work study is a term which embraces the techniques of 'Method Study' and 'work measurement' which employed to ensure the best possible use of human and material resources (Rahman, 2007).

3.2.1 Time measurement study

Time measurement study is also called work measurement. It is essential for both planning and control of operations. Time study refers the application of techniques designed to establish the time for a qualified worker to carry out a specified job at a defined level of performance (Rahman, 2007). The work study focused on nine building construction projects consists 4 residential building, 2 office building, 1 car park, 1 hotel building and a factory building which were carrying plastering works on site. Complete time measurements of the works were recorded in order to carry out the research study. The data collected with the help from supervisors and the labourers.

3.3 SEMI STRUCTURED INTERVIEW

The main objective of the interviews is to identify the solutions to increase productivity of labourers in plastering works in the Sri Lankan building context. According to Sekaran (2003), when interviews are conducted in semi-structured manner, it permits to adapt the queries necessary, clarify doubts and ensure that the response is appropriately understood by repeating and rephrasing the questions. Therefore, semi-structured interviews would be conducted with 10 professionals in construction industry includes project managers, site engineers, planning engineers and technical officers to achieve objective of the research. At the same time, labour interviews also covered to ensure the validity of data.

4. Research Findings and discussion

Research findings collected from the work study and interviews. Complete time measurements of the works were recorded in order to carry out the research study. The data collected with the help from supervisors and the labourers. Identified factors related to labour productivity has been compared with literature findings and discussed under this section.

4.1 WORK SCHEDULING

Construction professionals stated that schedule compression may effects the labour productivity either positively or negatively. During a schedule compression period, labourers are motivated by the company to work efficiently and effectively in order to achieve target on time. Thus, the productivity rate will tend to increase more. On the other hand, more resources are scheduled by project planners to the work in a compression period. As a result, non-productive time of labourers has a tendency to rise. Construction professionals always consider about this non-productive time of labourers, because, it effects the productivity rate. They held that outdated schedules, schedule communication errors, complicated programme and lack of details are main reasons of productivity loss.

In plastering works, some skilled labourers have a capacity to complete more areas in one day, but some skilled labourers have not that capacity. As same as, work pressure may reduce their working capability. Therefore these matters should be considered in work scheduling on site.

4.2 MANAGEMENT SKILLS

Several projects mainly concern on early finish of works. Thus, the managers drive the labourers to do the work on time. It results high productivity and reputation to the firm. Yet, workers are highly paid by them to achieve the target. It may reduce organization's profit margin. Interview respondents said that they appoint sub-contract labourers to finish projects as soon as possible. In addition to that managements hire labourers for low cost and get high profit on it. However, their working speed much lesser than highly paid workers.

Table 2: Data regarding average income of gang per hour

Site	Direct/ Sub Labour	Average Income of gang per Hour (Rs/hr)	Total productivity (m ² /hr)	Total productivity (m ² /Rs)
A1	Direct	84.72	0.46	0.0054
A2	Direct	80.56	0.39	0.0048
A3	Direct	83.33	0.45	0.0054
B1	Sub	141.67	0.59	0.0042
B2	Sub	137.50	0.63	0.0046
B3	Sub	141.67	0.65	0.0046
C1	Sub	133.33	0.71	0.0053
C2	Sub	127.78	0.58	0.0045
C3	Sub	133.33	0.73	0.0055

Table 02 obviously stated that average productivity of direct labourers little bit higher than sub-contract labourers in terms of money. On the other hand, hourly productivity rate of the direct labourers is much lesser than sub-contract labourers. Moreover it will result in late completion of projects and it will directly affect to the company reputation. Selecting suitable labour gang to the suitable area is another important thing in management. Interviewees pointed out that a good manager can get maximum output from the average level workers. In a critical plastering area, managers can appoint efficient work force to get higher productivity. In certain instances, inefficient management may waste the labour resource.

4.3 LABOUR MOTIVATION

Labour motivation is also one of the factor which affects the labour productivity. The respondents said that empowering employees is one way to encourage employee motivation, whereas empowerment can be achieved in the way of salary level, timing of payment, provision of transportation, proper communication etc. At the same time they held that unmotivated workers can cause loss of productivity associated with excessive down time and lack of concentration.

As per collected data, average productivity level of the labourers is increasing in accordance with average salary level. With attention to first instance, where skilled labourers get 800 rupees, average productivity level was very low compared to other ones. As a result, they work for long hours beyond the limited working hours to get more money. For example, in the site A3 workers were working routinely from 8 am to 10 pm anyhow it will increase the total output. On the other hand it will decrease the productivity of the labourers.

During the conversation with the labourers, they held that they were reluctant to work when payments are delayed or like to be delayed. Some instances they may go for strike to get reasonable solution. With regard this matter, professionals stated that salary delay may be occurred by the delay in payment due on an interim bill or insolvency of the contractor.

4.4 QUALITY OF MATERIAL AND EQUIPMENT

In the studies, it was identified that the common plastering mixes are 1:3 and 1:5. In some sites these mix proportions were not in accordance with mix proportions stated in BOQ. The main reasons for that were less experienced workers, ineffective supervision and so on. The workability of the mix should be ensured by mix proportions.

Table 3: Type of the mix vs. average productivity

Type of the mix	Nr of sites	Average productivity (m ² /hr)
1:3	06	0.62
1:5	03	0.50

Table 3 shows that mortar mix 1:3 has high workability than 1:5 mix. The first mix has high bonding capacity, thus the mortar easily bonds with the surface. As a result the productivity is higher in first proportion. Furthermore, selection of the appropriate type and size of construction tools often affects the required amount of time to complete the work, therefore, site managers/supervisors should be familiar with the characteristics of the major types of tools and equipment most commonly used in construction. During the conversation with the workers, they said that their own tools were more convenient to use for the works. A good trowel and hawk tool are necessary to apply the mortar on the surface. At the same time clear straight edge will help to level the mortar surface. If the length of straight edge is high, then the area coverage for the plastering work will increase within the given time. Therefore, total productivity of the work also increase. Further, plumb is also an important tool to ensure the verticality of the plaster. If the plumb is inaccurate, the rework will encounter in the site, which will reduce the total productivity of the work. In addition, smooth finish of the surface is guaranteed with the help of proper float. Workers always seek good tools to finish the work tidily, since they rely on it.

4.5 AVAILABILITY OF MATERIALS AND TOOLS

Availability of materials and tools also one of the factor which affects the productivity in severe manner. The respondents held that if the system cannot detect shortages far enough in advance of material needs, the result is last-minute shuffling of work crews. If the quality of materials supplied is sub-standard, either the material is rejected or it is used, but requires additional man hours to install. Rejected material must be removed and replacement material handled; both operations require unanticipated man hours which may affect the productivity of the labourers.

The professionals noticed that effect of poor material management is delays in delivery. These delays have an effect similar to errors in quantities, because the work flow is disrupted and must be re-planned. Disruptions cause lost time and necessitate non-productive work to remedy the situation. As same as the material management, location of the work also has an effect on availability of material. As per the work study, results are summarized below;

Table 4: Location of the work vs. Average productivity

Site	Location of the work (floor)	Hoisting method	Total productivity (m ² /hr)
A1	Ground	No	0.46
A2	6th	Mobile crane	0.39
A3	2nd	Mobile crane	0.45
B1	3rd	Mobile crane	0.59
B2	1st	Chain block	0.63
B3	Ground	No	0.65
C1	10th	Tower crane	0.71
C2	16th	Tower crane	0.58
C3	5th	Tower crane	0.73

According to the table 4, the flow of the productivity is not in a sequence manner. The reasons behind the instances are depend on some other factors described in the research. At the same time usage of equipment also has a significant effect in this regard. Most of the sites have either tower or mobile crane to hoist the materials to the correct position; as a result productivity may vary from site to site.

4.6 SUPERVISION

Supervision is a site management factor, which directly effects the labour productivity. The interview respondents said that direct supervision is much needed for the successful work completion on site. In the case, supervisor must have the competence to guide the labourers to achieve the desired goals, since, inefficient supervision may lead for reworks, slowdown of works, errors in the works and loss of profit. Sites, which have supervision, got higher productivity than the other ones. Putting plaster guide, checking plumb level, quality checking, guiding the labourers are the main areas of work supervisors to

perform. Thus, supervisors must accomplish their tasks in an efficient way to overcome the productivity issues.

4.7 OVERTIME

There is a contradiction exists among the professionals about the overtime factor relating to productivity; whether it affects or not. However, most of them noticed that working overtime will not give serious impact on productivity up to certain extent. Because, the normal working period is 8am to 5pm but workers can continue the work until 8p.m. or 9p.m. without losing their ability. Then, there could be loss of productivity beyond that time period due to some reasons, such as; loss of concentration, reduced supervision effectiveness, reworks, accidents and etc.

During the work study, it is noticed that workers were working very slowly until the evening and seek for overtime to complete the job. Especially on sites A1, A2 and A3 had this situation. The obvious reason behind the situation can be identified as salary level. If the workers got low salary level then they will seek for overtime works to cover-up the insufficient salary level.

4.8 SITE ACCESS ISSUES

Site access must be cleared prior to commence the work, if not, the non-productivity time of labourers have a tendency to rise. Thus, productivity will fall down. Interviewees identified that interference to the convenience or planned access to work areas are due to blocked stairways, roads, walkways, insufficient man-lifts, or congested work sites.

Table 5: Place of plaster vs. Average productivity

Int/Ext plaster	Nr of sites	Average productivity
Int/Ext plaster	01	0.46
Internal plaster	05	0.63
External plaster	03	0.52

Site access may depend on the place where plaster is applied. External plastering has high difficulty and poor access than the internal plaster. Working space, scaffolding preparation and access permission are some reasons which should be considered in external plastering. *Table 5* illustrates the place of plaster vs. average productivity, while the high productivity (0.63) is achieved in internal plastering. Since there may be easy access in internal plastering than the external one.

4.9 QUALITY & EXPERIENCE OF MANPOWER GROUP

Workforce characteristic factors must be considered by professionals to achieve desired productivity of labourers. These factors consist with age of the labourers, experience of the workers, quality of the workers and size of the crew. Site manager should check and evaluate these factors in order to carry out the works.

Table 6: Age class vs. Average productivity

Age class (Yrs)	Nr of labourers	Percentage	Average productivity (m²/hr)
20-25	04	15.38 %	0.59
25-30	08	30.77 %	0.57
30-35	03	11.54 %	0.55
35-40	04	15.38 %	0.65
40-45	03	11.54 %	0.47
45-50	01	3.85 %	0.45
Over 50	03	11.54 %	0.43

As per the table 6, nearly 31% of workers in the age group 25-30 years and it exposed that the young generation's involvement in construction industry is become viable in nowadays. It's somewhat healthy to the industry, where, innovations, better improvements, self-motivation and quality of work may arise in that age period.

Table 7: Experience vs Average productivity of labourers

Experience class (Yrs)	Nr of Skilled labourers	Average productivity (m ² /hr)
0-5	02	0.49
5-10	10	0.60
10-15	05	0.58
15-20	18	0.46

According to the table, it has revealed that the productivity will tend to reduce after 10 years of experience. This may be caused by aging of the labourers, less job satisfaction and less motivation. However, there is a quite higher productivity in 5-10 years' experience class.

4.10 EMPLOYEE TRAINING

The respondents held that the construction industry always seek for skilful labourers. Since, it can be achieved from proper education and training programmes. However, during the study it is noticed that the training programmes for plasterers is given only in the organisation A. Even though, the productivity is little bit lower than the other organisation. The managers of the organisation A explained that the benefit of the training programmes will focus on long term basis. Thus, it cannot expect the high productivity in short term period.

Method of learning also incorporate in productivity issue. Course based learning and the traditional learning are the two main methods of learning available in the industry. Some technical colleges provide the technical studies along with the training. At the same time, traditional method of learning is given by experienced labourers to unskilled labourers, thus, they will catch-up and become skilful workers in the industry. However, in the traditional method, skilled labourers are reluctant to teach their subordinates, since, they believe that the subordinates will catch their place in the industry.

Table 8: Method of learning vs. Avg. productivity of labourers

Method of learning	Nr of skilled labourers	Avg. productivity (m ² /hr)
Course	04	0.54
Traditional	14	0.59

According to the *Table 8*, productivity from traditional method of learning is little bit higher than the course based learning. However, as per the professionals thought aforesaid, the benefits are planned in long term basis. In some sites, the workers are advised and trained to minimize the wastage in the work. The wastage reduction is incorporated with labour training, while, the well trained worker can judge how to execute the work with efficient way.

4.11 WEATHER FACTORS

Weather condition also is a factor which effects the labour productivity. The weather condition of the sites includes temperature, raining pattern, and humidity level and wind movement. Up to some extent weather conditions are unpredictable. In that case, it causes delays and disruption to the works. Thus, the productivity tends to fall down.

Table 9: Weather condition vs. Average productivity of labourers

Weather condition	Nr of sites	Avg. productivity (m ² /hr)
Normal	7	0.60
Mild rainy	1	0.59
Rainy	1	0.39

According to the *Table 9*, in a rainy situation the productivity of the workers decreases than usual. Because, non-productive time of labourers is high in rainy conditions. However, site manager must aware of these situations and plan for the works regard to the site weather status. Labourers cannot do the external plastering work, when, rain falls severe in the site. Though, they can arrange the internal plastering works.

Humidity level also got effects in plastering work. The plasterers are required to wait for a period, allow to dry the surface after applying of plaster prior to level the surface. If the environment become saturated then the waiting period will tend to be long, thus, the productivity tends to decrease. Moreover, saturation becomes high in rainy season.

Furthermore, temperature also effects the labour productivity. The respondents said that too hot temperature or too cold temperature is not suitable for construction works. The work study results are summarized below;

Table 10: Temperature vs. Average productivity of labourers

Temperature	Nr of sites	Avg. productivity (m²/hr)
27	2	0.49
28	6	0.60
29	1	0.63

As per the *table 10*, the productivity become higher in accordance with site temperature. The higher productivity (0.63) is recorded at the temperature of 29° Celsius.

However, the contractor must be aware on the humidity level and the temperature. If the site environment becomes fully saturated at certain temperature, then there will be long time required to dry the surface. On the other hand, if the saturation becomes lower than usual, then the plaster will quickly dry after mixing. Thus, the mortar's adhesive efficiency will be reduced and consequently, it would not be suitable for plastering works. Therefore, engineers must forecast the weather conditions.

4.12 SAFETY ISSUES

Many professionals explained that the safety issues has positive effects on labour productivity. Some workers productivity may decrease with safety equipment in the way of taking certain time to adjust helmets, safety belts and gloves. However, it will reduce the accidents arise in the sites, thus, it is beneficial to the contractors as well as the workers.

Moreover, the respondents said that the construction is one of the most unsafe industries and the major causes of accidents are related to the unique nature of the industry, human behavior, difficult work-site conditions, and poor safety management, which result in hazardous work methods, equipment, and procedures. Preventing occupational injuries and illness should be a primary concern among both employees and employers.

In a construction site, safety may be categorized with the height of the work. The risk may be high in accordance to the height of work. Thus, the data arrived from the studies are tabulated below;

Table 11: Height of scaffolding vs. Average productivity of labourers

Height of Scaffolding (m)	Nr of sites	Avg. productivity (m²/hr)
2	6	0.61
12	1	0.59
21	1	0.39
60	1	0.58

According to the *table 11*, labour productivity has inverted relationship with the height of work. The safest place to work is in floor level, since it has discovered in the picture, where the high productivity (0.61) is recorded in the height of 2m. The interviewees stated that in the construction industry, the working environment is constantly changing sites that exist for a relatively short time as well as activities and inherent risks that change daily. Thus, the safety plan must circulated among the workers to cover all risky situations.

5. Conclusions

In conclusion, it can be affirmed that the aforementioned factors have significant impact on labour productivity in plastering works. However, the degree of impact may vary from factor to factor.

Thus, finding the correlation between productivity and the factors will help to predetermine the impact on labour productivity and, it leads to better improvements in the construction industry. It is expected that the findings of this research will assist professionals to be aware on labour productivity issues.

During the work studies and the interviews, it has revealed that the industry suffers from labour productivity. Thus, the solutions for increasing labour productivity are analysed on the basis of interviews and work studies.

Schedule the work on site with appropriate resources in order to avoid poor scheduling, Select proper gang (direct or sub contract) to the work area to ensure the proper completion and profit, Provide guidelines about the labour attitude to the site. Starting time of work, lunch and tea breaks and, over time should be strict by the management, motivate the workers by the way of financial and psychological terms. Offer gifts and incentives to the good workers. At the same time, talk personally with the workers and, identify their problems, Assign 'Quality Assurance' team to ensure the quality of the material and tools within the site, Practice 'waste management strategy' within the site to increase efficiency of the labourers, Ensure material procurement and management system is effective on site to reduce waiting time and work delay, Appoint qualified staff to the site, which will always increase the labour productivity, Forecast the climate conditions to avoid unnecessary struggles within the site

6. References

- Alan, H. (1987). *Improving site productivity in the construction industry*. Geneva: International Labour Organisation.
- Ameh, J. O., & Itodo, E. D. (2013). Professionals' views of material wastage on construction sites and cost overruns. 747-757. doi:10.5592/otmcj.2013.1.11
- Creswell, J. W. (2003). *Research design* (2nd ed.). London: Sage publications Ltd.
- Enshassi, A., Mohamed, S., Mustafa, A. Z., & Mayer, P. E. (2007). Factors affecting labour productivity in building projects in the Gaza strip. *Journal of Civil Engineering and Management*, 13(4), 245-254. doi:10.1080/13923730.2007.9636444
- Gihan, L. G., Ahmed, R. A., & Adel, E. G. (2010). *Material waste in Egyptian construction*. Egypt: University of Cairo.
- Lema, N. M. (1995). *Construction of labour productivity modeling*. Dar Elsalaam: University of Dar Elsalaam.
- Missbauer, H., & Hauber, W. (2006). Bid calculation for construction projects: Regulations and incentive effects of unit price contracts. *European Journal of Operational Research*, 171(3), 1005-19. Retrieved from <http://dx.doi.org/10.1016/j.ejor.2005.01.014>
- Mojahed, S., & Aghazadeh, F. (2008). Major factors influencing productivity of water and wastewater treatment plant construction: Evidence from the deep south USA. *International Journal of Project Management*, 26(2), 195-202. doi:10.1016/j.ijpr oman.2007.06.003
- Ovararin, N. (2001). *Quantifying productivity loss due to field disruptions in masonry construction*. Austin: The University of Texas.
- Punch, K. F. (2005). *Introduction to social research: Quantitative and qualitative approaches* (2nd ed.). London: Sage publications Ltd.
- Rojas, E. M., and Aramvareekul, P. (2003). Labour productivity drivers and opportunities in the construction industry. *Journal of Management in Engineering*, 2(1), 78-82. Retrieved from [http://dx.doi.org/10.1061/\(ASCE\)0742-597X\(2003\)19:2\(78\)](http://dx.doi.org/10.1061/(ASCE)0742-597X(2003)19:2(78))
- Rahman, N. B. (2007). *Work study for labour productivity improvement utilizing process mapping and MOST* (Bachelor's thesis in manufacturing engineering). University Teknikal, Malaysia.
- Rowlinson, M., & Proctor, S. (1999). Organizational culture and business history. *Organization Studies*, 20(3), 369-96. Retrieved from <http://dx.doi.org/10.1177/0170840699203001>
- Sekaran, U. (2003). *Research methods for business: A skill building approach* (4th ed.). New York: John Wily & Sons.
- Teo, S. P., Abdelnaser, O., & Abdul, H. K. (2009). *Material wastage in Malaysian construction industry*. International conference on economic and administration. Romania: University of Bucharest.
- Thomas, H. R. (1991). Labour productivity and work sampling: The bottom line. *Journal of Construction Engineering and Management*, 117(3), 423-444. Retrieved from [http://dx.doi.org/10.1061/\(ASCE\)0733-9364\(1991\)117:3\(423\)](http://dx.doi.org/10.1061/(ASCE)0733-9364(1991)117:3(423))
- Thomas, N. S., Skitmore, M. R., Lam, C. K., & Poon, A. C. (2003). Demotivating factors influencing the productivity of civil engineering projects. *International Journal of Project Management*, 22(2), 139-146. doi:10.1016/S0263-7863(03)00061-9
- Wilcox, S., Stringfellow, B., Harris, R., & Martin. (2000). *Management and productivity*. USA: Transportation research board.
- Zakeri, M., Harris, F. C., Holt, G. D., & Olomolaiye, P. O. (1996). A survey of constraints on Iranian construction operatives' productivity. *Construction Management and Economics*, 14(5), 417-426. doi:10.1080/014461996373287

Samarawickrama, Sumanthri, et al (eds), 2018, "Sustainability for people - envisaging multi disciplinary solution": *Proceedings of the 11th International Conference of Faculty of Architecture Research Unit (FARU), University of Moratuwa, Sri Lanka, December 08, 2018 Galle* pp. 280–291. ©

THE IMPACT OF LANDSCAPE CHARACTERISTICS OF URBAN POCKETS ON VISITORS AND RESIDENTS

A study with reference to Kandy City

MADAWALA. W. R. H. B. Y. M. R. S. R.¹ & CHANDRASEKARA. D. P.²

Department of Architecture, University of Moratuwa, Moratuwa, Sri Lanka

¹*sajnimadawala@gmail.com*, ²*dpcha@uom.lk*

Abstract

The urban pockets can be identified as an important component within the city. There are two main categories of users of urban pockets; the residents and the visitors. The objective of this study is to investigate the impact of landscape characteristics of urban pockets on these two main user groups. According to the salient perceptual dimension, the individual preference of landscape is affected by three characteristics; landscape, personal and contextual. The study focuses only on the landscape characteristics, which can be divided further in to two; Content-based characteristics and spatial configuration characteristics. According to the Kaplan's information processing theory, the coherence, complexity, legibility and mystery which are components of spatial configuration characteristics, make a significant impact on the user preferences. Kandy, one of the main cities of Sri Lanka has a combination of natural, built and the historical characteristics. Three urban pockets of Kandy city were selected for the case studies; Lake round, Market front and Dalada veediya. Literature review, observation, mapping and questionnaire survey have been carried out in both pilot and field studies as data collection tools, for a sample of 15 persons for each location. The findings of the study lead to identify the patterns of user preference. The spaces of urban pockets with higher level of Coherence and legibility, communicate more with the visitor. The areas with moderate level of complexity and mystery also attract the visitor more. The extremes of high and low levels of complexity and mystery is more related to residents. The study also identifies that the separation of visitor and resident is best achieved not by geographical demarcations, but by the frequency of visits.

Keywords: *Landscape characteristics; Landscape preference; Individual preference; Visitors and Residents; Urban pockets.*

1. Introduction

Simplest definition of Urbanization is that, it is the process of making a particular area more urban. That refers to the population shift from rural areas to the urban which gradually increases the figure of people living in urban area. This process has become the reason for the formation of towns and cities.

The development process of cities inevitably produce pocket spaces, between buildings, between ground levels, and along the streets within cities, which are defined by the placement of infrastructure in to an existing urban fabric. As these spaces are formed within the cities, the users of the cities vary from the community who live there to the visitors who visit the city from far away. This implies that the usage of the places differs from each other with respect to the community who use it. In this case they can be identified as residents and visitor. The reasons for this varied preference of landscape preference among urban pockets will be discussed and studied under this topic.

1.1 NEED OF THE STUDY

As a tourist-based city, Kandy attracts a higher number of local and foreign visitors. Apart from that the city is used by the residents of the city and the immediate sub urban areas daily for their needs. As both the above places; where the visitors attract and where the needs of the general public lays, are both connected and located near to the city centre, the urban pockets that cater for them has an importance

and needs attention. Considering the current situation in Kandy city, few urban pockets can be identified, which are formed mainly with the interests of the people. The user percentage (residents and visitors) of these places varies due to the characteristics of those particular places. Identification and the understanding of the above factor has an important role in the fields of landscape architecture and urban design.

1.2 RESEARCH QUESTION

The research aims to find how the landscape characteristics of urban pockets impact the footfall of visitors and residents comparatively.

Landscape characteristics with the natural, historical and religious backgrounds attracts people to the city from outside of Kandy. These users have created the current urban pockets according to their preferences, through which we identify a difference in footfall of residents and visitors. The factors which cause the above variation is very important in the process of development in such cities for formation of spaces. This connection or the relationship of the user with the landscape characteristics, with respect to the familiarity of the user is studied and analysed under this study.

1.3 OBJECTIVES OF THE STUDY

- To identify the landscape characteristics affecting the city user (residents and visitors) landscape preference.
- To identify the variation of the user groups (residents and visitors) footfall with the previously identified landscape characteristics.

1.4 SCOPE AND LIMITATIONS

This study will only focus on three case studies identified by the author through the observations, which comes under the category of urban pockets formed by the users themselves, as defined above. Even though the number of factors affecting the individual landscape preference have identified through the literature review, only few factors were considered in the study including the category of spatial configuration characteristics under landscape characteristics. A random small sample of fifteen (15) people from each case study (three case studies) were taken for the questionnaire survey of the study.

2. Landscape preference in urban pockets

In the discussion of Landscape preference in urban pockets, the study focusses on two factors, which are the city and its landscape characteristics, and the landscape preference of people.

2.1 THE CITY AND LANDSCAPE CHARACTERISTICS

“A city is a multi-purpose, shifting organization, a tent for many functions, raised by many hands and with relative speed.” (Lynch, 1960)

Through the process of increasing percentage of population, or the urbanization, gradually a city is formed. Then being umbrella for the services and activities of its population the ‘form’ of the city occurs. Kevin Lynch, in his book “The image of the city” refers a city as piece of architecture, which is a production of a long time period in a large scale. In a way, it is a construction of space. He also relates the city design to a temporal art considering its process of forming.

In a broader scale, the product might look generally constant, while it changes all the time (narrower scale) in detail. Therefore, the city can be considered as a continuous succession of phrases, and which does not have a final result. The control over the above continuity of growth is partial. (Lynch, 1960)

The city is identified in two types by Christopher Alexander in his work.

“Natural cities – Arisen spontaneously over many, many years

Ex: Siena, Liverpool, Kyoto and Manhattan

Artificial cities – Cities or parts of the cities which are deliberately created by designers. Ex: Levittown, Chandigarh and the British New Towns” (Fernando, 2016)

The landscape characteristics are defined as unique aesthetic features distinguishing one scene from another in a certain time, within a defined space range by Yu in 2008. “It is the expression of the unique aesthetic features of the landscapes” (Min Wang, Bochun Yu, 2012). Within the process of forming the city, happens urban pockets within the landscape. These can be spaces between buildings, between the ground and the ground within cities, along the walkways, nodes, etc. which are defined by the placement of infrastructure in to an existing urban fabric.

2.2 LANDSCAPE PREFERENCE

This society has been playing a significant role in creating or forming the landscape. Each human being, as the smallest unit of the society can be simultaneously defined as, a biological organism; a person with a unique set of capabilities, experiences, and aspirations; a social being acting within various roles in various groups; and a carrier of culture (e.g. Bourassa 1991).

According to the Rachel and Stephen Kaplan, preference can be defined as an indicator of aesthetic judgement and as a complex process which involves perception of things and spaces and reacting to them in terms of their potential usefulness and supportiveness. Preference for specific landscapes is about the organization of the space, rather than the individual element.

According to the Kaplans’ Information processing theory (1979), “We gather information from our environment through our senses, mostly through visual sense. Kaplans’ theory suggests that information is derived through the contents and the organization of the environment.” (Ozyavuz, 2012). With the results of their studies Rachel and Stephan Kaplan developed a matrix for preference. It contains four informational factors which affect the Landscape preference.

Table 25 Kaplan’s preference matrix (1998)

	Understanding	Exploration
2D	Coherence	Complexity
3D	Legibility	Mystery

Coherence: Coherence of a setting is about the order and organization of its elements. It can be achieved through repetition of themes and unifying textures, the limited degree of contrast is also can be helpful.

Complexity: this factor refers to the degree of diversity of landscape elements. An environment with greater variety would encourage the exploration within people.

Legibility: this is basically the readability of the environment. This focuses on the orientation of people in a particular environment. Landmarks or focal points increase the legibility of places.

Mystery: It is about the environment’s potential of promising information and exploration related components of preference. According to Kaplan, curved path ways and vegetation that partially block the view can be considered as examples. (Ozyavuz, 2012)

How the people perceive or evaluate the landscape largely depends on their basic needs and motives. Thus, in Landscape preferences, individual differences may arise as they seek out fundamentally different experiences in the environment. (Berg, Van Den, A. E., 1999)

Individual differences in landscape preferences have been discussed under three terms.

- Landscape characteristics
- Personal characteristics
- Contextual characteristics

According to the Salient Perceptual Dimensions, Landscape characteristics underlying environmental perceptions and categorization can be classified in to two major types.

- Spatial configuration characteristics

Which refers to 'the way elements are arranged in the implied space of a scene'.

- Content-based characteristics,

Which refers to 'specific objects or elements in the landscape'.

Spatial configuration characteristics can be discussed in relation to two basic informational needs.

- Understanding: comprehending or making sense of a landscape.
- Exploration: being attracted to additional source of information.

Under the above mentioned 'Understanding', degree of coherence and the degree of legibility are discussed. Under the informational need of 'Exploration', degree of complexity and the mystery, or the degree to which a particular landscape offers a promise of more information are discussed. (Berg, Van Den, A. E., 1999)

3. Application of theoretical framework

3.1 RELATED THEORIES

Theoretical framework has been formed with consideration and deep study on several theories that has been proved and discussed. Referred theories are mentioned below.

Figure-ground theory

This is one way of understanding the city/space, through its classic way of spatial relationship in two-dimensional form with Nollie's map which has become an analytical. Through this, it is understood that the city with its public and private spaces (solid/void, open/closed, black/white). (Daniel Kiss, Simon Kretz, 2016)

Linkage theory

This theory is based on connections between different elements. These are like streets, pedestrian paths, riverbanks or other linear spaces that connect parts of the city (glue of the city).

Place theory

Based on cultural and human characteristics of physical space that is on its psychological dimension. 'Physical space gains additional richness through unique details that are rooted in its settings' (Genius loci) and its use.

Prospect-refuge theory

Appleton's prospect-refuge theory is about preferences for landscapes which provide "prospect" and "refuge" opportunities. According to Appleton, Prospect-refuge theory is based on human's urge to feel safe and to survive. Human being intrinsically tends to prefer environments that provide us with the ability to hide while observing surrounding.

Information processing theory

A theory of landscape preference. We gather information from our environment through senses, mostly through visual senses (Kaplan). Information is derived through the contents and the organizations of the environment. And this theory includes four informational factors, coherence and legibility under the understanding of an environment, and complexity and mystery under the exploration of the environment. (Kaymaz, 2012)

3.2 THEORETICAL FRAMEWORK

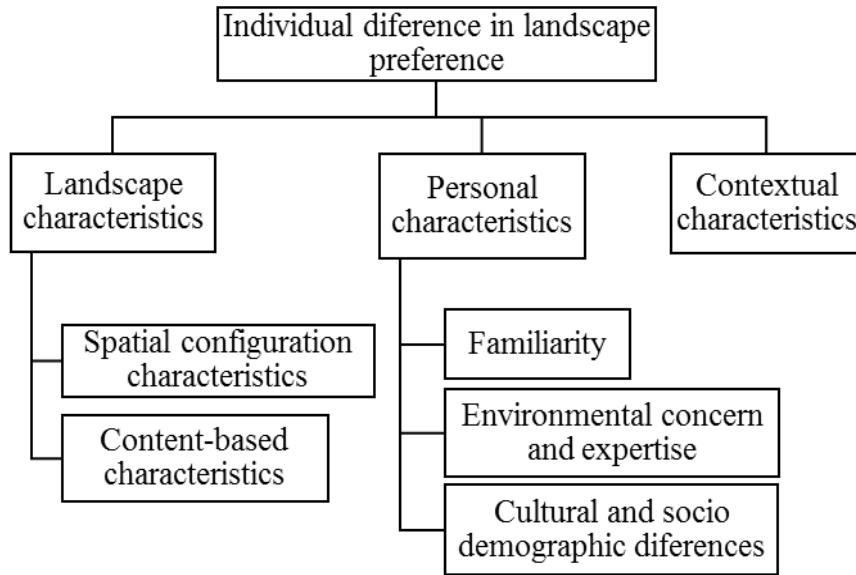

Figure 30 Individual difference in landscape preference, compiled by author

Landscape characteristics

Landscape characteristics can be identified as an important requirement for any systematic analysis of individual differences in landscape preference and these differences should be related to Landscape characteristics.

- Spatial configuration characteristics: the way elements are arranged in the implied space of a scene.
- Content-based characteristics: presence of a specific object or an element in the landscape.

Personal characteristics

Personal characteristics respond to the three main classes of characteristics as they are typically distinguished in discussions of individual differences in landscape preference.

- Familiarity
- Environmental concern and expertise
- Cultural and socio demographic difference

Contextual Characteristics

In general, contextual characteristics may be defined as all variations among judgmental context that influence people’s perception and evaluations.

3.2.1 Landscape characteristics

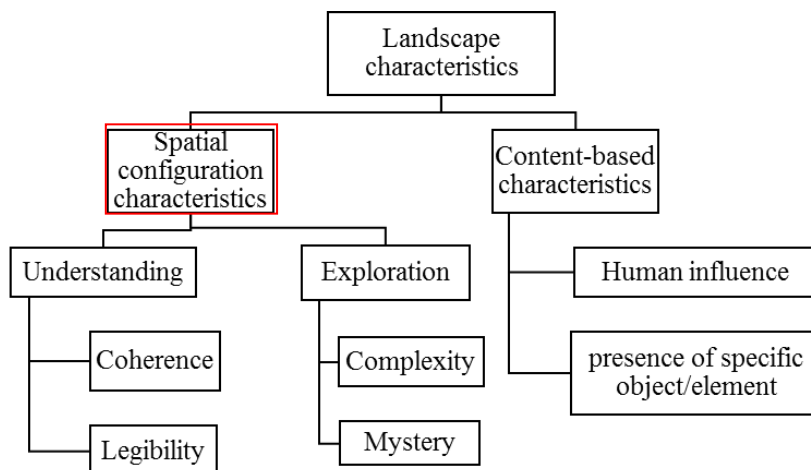

Figure 31 Landscape characteristics categorization, compiled by author

Coherence	→	Repetition of elements Order of elements Fragmentation of elements Presence of water
Complexity	→	Diversity of land use Diversity of shapes of elements Diversity of the sizes of elements
Legibility	→	Presence of landmark elements
Mystery	→	Curved pathways and blocked views (Asa Ode, Mari S. Tveit, Gary Fry, 2008)

4. Methodology

The methodology used for the study is a mixed method and it will have two folds, namely a literature survey and case study survey. Literature survey has been carried out to gather data on theories and arguments related to this matter, including urban pockets, landscape characteristics and individual landscape preference. In this literature survey, factors which affect for effective landscape designs given by different scholars will be listed out and the common factors have been taken for the formation of the theoretical framework of the study. Then these factors will be further discussed on how they affect the individual landscape preference.

The above-mentioned case study survey has been carried out in two stages; Pilot study and the Field study. Pilot study has been completed using methods of observations, interviews and cognitive maps prepared by two colleagues who represent the residents and visitors by geographical demarcations. The field study has been completed by using research tools of observations, mapping and questionnaire surveys which has been carried out using 15 respondents (randomly selected users) from each case study. These collected data has been analysed separately and discussed together to extract the conclusion of the study.

5. Case studies

Three case studies are being selected from Kandy city, which is a natural city located in the central province of Sri Lanka. This is a heritage city that has been developed preserving the natural environmental background as well as its' historical and religious background. The selected case studies are Lake round, Dalada veediya and Market front which are located within the city boundary and proximity to important land uses of the city.

5.1 CASE STUDY 01- LAKE ROUND



Figure 32 Lake round

One side of the site's boundary is the Dalada veediya, which is a one-way street running from the entrance of the Temple of the tooth to the city centre. And the Queens hotel building facing the street becomes the building façade for the site. Other boundary of the site is the Kandy Lake. This side of the site open up the view to a vista which includes the mountainous back drop. The 'waluka bemma' around the lake increases the aesthetical value of the lake as well as giving a cultural value.

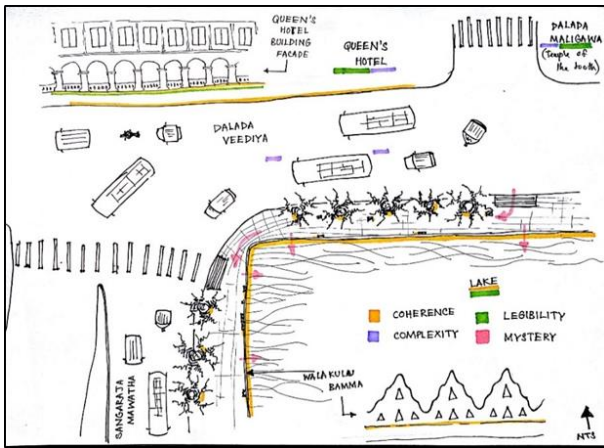

Figure 33 Lake round layout by author (presence of spatial configuration characteristics)

“Waluka bemma” around the lake runs along linier site repeating its form. Apart from that main element that follows the repetition, the tree line, the paving stone and even the Queens Hotel building façade has a glimpse of repetition affecting the site. The composition of the elements seems to be done in an order, with tree line, paving stones, edges and even the vendors are occupied forming an order within the site. Any fragmentation of order or a character is not identified within the space. The presence of water covers the most of the site than the others with the presence of the Kandy Lake. Altogether, Lake Round can be identified as space with high Coherence.

When it comes to the Complexity of the site, the diversity of the land usage is comparatively low. The main land use of the site is the walk way (recreational), which has now joined with very little commercialized vendors, ‘Joy boat’ boat service, one-way road (Dalada veediya) and religious activities. Even though the Temple of the tooth is a huge attraction of people, it does not create any complexity within the space. Apart from that, the variation of the size and shapes of the elements generate a certain level of complexity within the site. Therefore, the Complexity of the space can be identified as comparatively less.

Considering the landmark elements within the site, Kandy Lake can be identified as a natural, landmark element. Then the Temple of the tooth which is a historical and a religious landmark element and the Queens Hotel building a historical and architectural landmark takes the courtesy.



Figure 34 Visual accessibility above the waluka bemma

Curiosity of the space is shaped with blocked views and curved pathways. Even though the walk way curves up around the Lake, within the site creating a very little curiosity on the users’ mind. The low built waluka bamma and the other unblocked views towards every side terminate the curiosity within the site, reducing the level of mystery of the site. Nevertheless, the hidden views of the water level and fish, along with the street vendors who are there after the bend (organic forms) of walkway manage to maintain the curiosity in a moderate level.

- Coherence - Very High
- Complexity- Low
- Legibility - Very High
- Mystery - Moderate

Comparison of the effect of spatial configuration characteristics on the visitor’s and resident’s preference is identified through the questionnaire survey.

The order in mean ratings by the visitor and resident on the effects of coherence, complexity, legibility and mystery are common. Nevertheless, the value of the rating varies. The two characteristics that focus on the understanding of a place, coherence and the legibility is highly rated by the visitors than the residents, but the variation of the other two characteristics which focus on the exploration of a space is different. The complexity has affected for the preference of the residents than the visitors. However, when it comes to the mystery, the mean rating by the visitors’ is higher than the residents’. In other

words, even though the mystery at the space is Moderate and both mean ratings by the visitors and residents are low, the curiosity of the place has an impact on visitor preference than the resident.

5.2 CASE STUDY 02- DALADA VEEDIYA WALKWAY

This space is formed along the Dalada veediya walkway with the building façade facing the road side, basically the pedestrian way. Dalada veediya runs towards the clock tower junction and the city centre from the side of Temple of the tooth. Considering the building façade that has the largest contribution for the formation of the space, it includes retail shops and street vendors who sell fancy stuff, clothes as well as cosmetics. Other side façade of the building is also another building façade facing the Dalada veediya and the site.



Figure 35 Dalada Veediya

Repetition and order can be identified through the handrail, light posts along the pavement, pavement as well as the tree line. Handrail carry the same language and the character of all the handrails within the context assisting the city to be identified as one system. Even the repeating light posts has a character which is unique and harmonious to the traditional city of Kandy. There is no identifiable fragmentation of contextual character within the space. In fact, this space can be considered as a part which contributes to the continuity of the contextual character. Moreover, the presence of water is one factor which cannot be identified within the space.

Considering the factors affecting the complexity, there is a comparatively moderate diversity of land use with the commercial buildings, pedestrian way, the road, moving people both ways and gathering people present at the space. Even the variation of the size and shapes are hardly noticed. Therefore, the complexity within the space can be rated moderate.

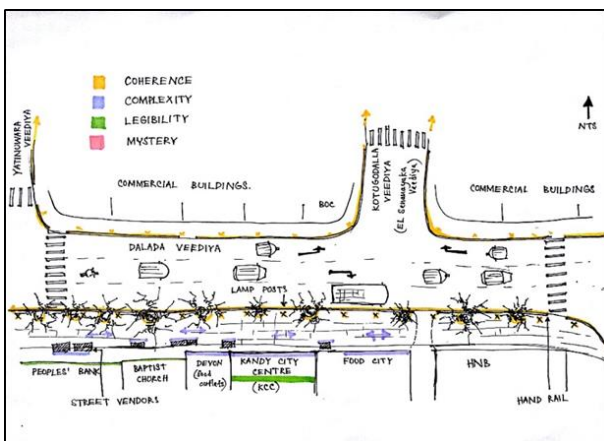

Figure 36 Dalada Veediya layout by author (presence of spatial configuration characteristics)

There is also a lack of landmark elements within the space. Kandy city centre entrance is one of the Landmarks. Few other spaces are known with the names of retail shops, which cannot be considered as landmarks for both visitors and residents equally. Therefore, the Legibility of the space can be rated comparatively low.

Mystery is measured with blocked views and curved pathways which is hardly identified within the space. This marks the space to be a low curious, or very low in mystery.

- Coherence - High
- Complexity - Moderate
- Legibility - Low
- Mystery - Very Low

Comparison of the effect of spatial configuration characteristics on the visitor's and resident's preference is identified through the questionnaire survey.

The impact of spatial configuration characteristics is discussed with reference to coherence, complexity, legibility and Mystery. The impact of coherence within the space for the individual preference of Dalada veediya is practically equal according to the mean effectiveness on preference level rated by both visitors and residents. The impact of complexity on visitors is identified to be higher than on residents. Moving on to the legibility, the mean preference level rated by visitors is lower than the residents'. When it comes to Mystery, both mean effectiveness levels on preference are very low. Although the effect on residents is comparatively higher than visitors.

5.3 CASE STUDY 03- MARKET FRONT

This is a space formed with the main entrance of the Market complex, Kandy. On the opposite side is the park and the vehicular parking. Therefore, the two facades of the side can be identified as the Market complex entrance and the park with the improper parking in front.

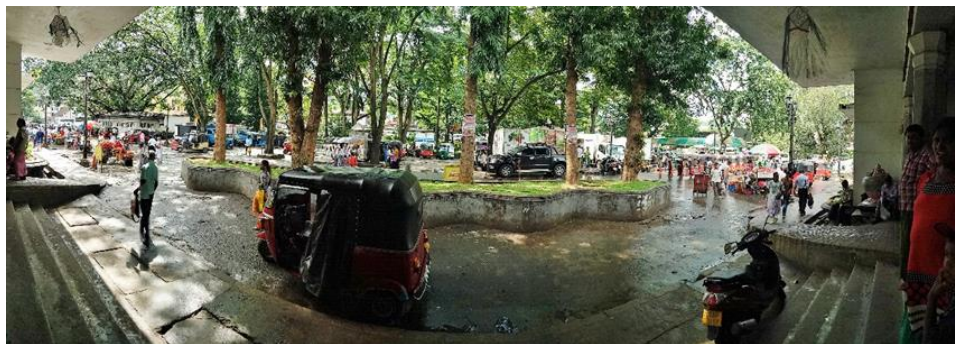

Figure 37 Market front

Repetition of elements or character is hardly present at Market front, except for the street vendors in a row and the pillars at the entrance of Market building. Considering the order within the site, order of vehicular parking, established locations of street vendors and the tree line in middle contributes for the coherence. Nevertheless, one lacking factor is the presence of water within the space.

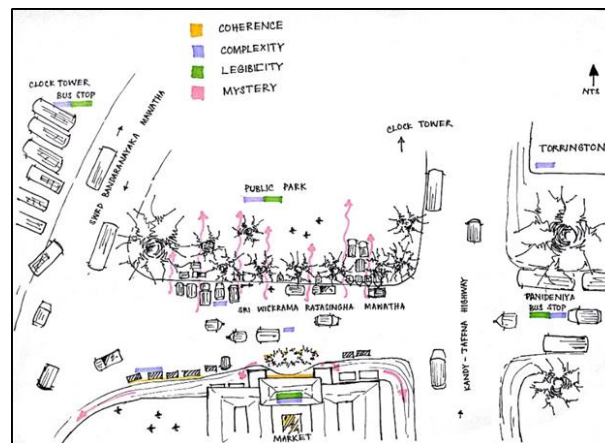

Figure 38 Market front layout by author (presence of spatial configuration characteristics)

Considering the Complexity within the space, it has a comparatively large diversity of land use within the site. The Market building, street vendors, market activities, vehicular parking, both vehicle and people's movements, nearby bus stops in both sides (services) and even the park in front altogether creates its micro level diversity of land use. Considering the shapes and sizes, the scale of the building

façade and its details are diverse comparing to the other elements like vendors' spaces and lottery spots. There isn't much diversity in vegetation scales and shapes.

There are also Landmark elements within and around the site including mainly the Market building. Apart from that, the bus stops in both sides and the Torrington complex stands as landmark elements which enhances the Legibility of the space.

The other factor of the spatial configuration, Mystery is measured by the blocked views from the site and its curved pathways. The bends towards both sides from the site create curiosity to a certain extent. Although the blocked view of the park by the parked vehicles and the blocked view of the clock tower area and the road (space beyond the park) by the park create more curiosity within the site.

Coherence - Low
 Complexity - Very High
 Legibility - High
 Mystery - High

Comparison of the effect of spatial configuration characteristics on the visitor's and resident's preference is identified through the questionnaire survey.

Considering the effect of coherence within the space, visitors' ratings are comparatively low than the residents'. It is also identified that the presence of coherence (repetition, order, fragmentation and the presence of water) is low, through the observations. When it comes to the effect of complexity, it is also rated comparatively low by the visitors than residents. Considering the diversity of the land use which is a strong factor that indicates the level of complexity, residents define this space as a centre of facilities or services. This easy access for the services does have a considerable impact on the residents, which can be identified through the open-ended questions which were asked at the questionnaire survey. Unlike the above two characteristics, the effect of legibility on the preference of the Market front is rated comparatively high by the visitors than the residents. This shows the visitors' focus on the landmark elements to read the space, other than the residents. When it comes to the effect of Mystery, there is a considerable difference between the ratings of visitors' and residents'. Visitors mean effectivity rating of mystery for preference is low while the residents' ratings are higher.

6. Findings and discussion

The presence of spatial configuration characteristics and its impacts are discussed here. The summary of the data collected through the study on this category of landscape characteristics and its analysis are given below to support the discussion.

Table 26 Comparative summary of spatial configuration characteristics

Case study	Coherence		Complexity		Legibility		Mystery	
	Presence at the space	Category that is affected more	Presence at the space	Category that is affected more	Presence at the space	Category that is affected more	Presence at the space	Category that is affected more
Lake round	Very high	Visitors	Low	Residents	Very high	Visitors	Moderate	Visitors
Market front	Low	Residents	Very high	Residents	High	Visitors	high	Residents
Dalada veediya	High	Visitors	Moderate	Visitors	Low	Residents	Very low	Residents

Considering the coherence, the coherence of spaces with higher presence of it, has a higher impact on the visitor; as in Lake round and Dalada veediya. Moving to the complexity, in spaces where either higher or lower presence of complexity is present, its effect on the residents is higher. Moderately presence of complexity has affected on the individual landscape preference of visitors more than residents. When it comes to the legibility, it follows a similar pattern like the coherence, where the presence of legibility is higher, the effect of it on the visitor is higher than the residents. The final

characteristic, Mystery's situation is similar to the complexity, where either higher or lower presence of mystery is affected on visitors comparatively low than the residents. Furthermore, it effected highly on the visitor by the moderately presence of mystery.

Apart from the above analysed data, a few factors can be opened up for the discussion with the individual study of the questionnaires of each case study, one by one. One is the residents' strong need or the routine of using spaces focusing on the services they get from the space overwriting the quality and the presence of landscape characteristics within the particular space. Another factor identified is that, the 'Familiarity' does not reside with the geographical location of the user residence, but with the frequency of their visits to the particular space. Situations were identified where the frequently visited visitor behaves and responds more similar to a resident, where the rarely visited resident responds more similar to a visitor, supporting the above statement/ situation. Moreover, the fact that a space can be more legible for a resident than visitors, as their number of identified landmarks are high with familiarity.

7. Conclusion

Current cities of Sri Lanka are formed with the urbanization process that occurred with the development of the country. The simplest definition for the urbanization is that a place getting urban, which includes the population shift from the rural areas to the urban areas, looking for the services and similar reasons. As a result of that, the city becomes a centre of service. This has made the cities more congested, inevitably creating urban pockets between buildings, between ground levels and along the streets which are defined by the placement of infrastructure of the city. These pockets were generally shaped and used by the people altogether. These users include both residents of the city as well as the visitors that come to the city for various reasons. Considering the landscape preference, the same space that is used by the residents can be perceived by the visitor in a different manner, depending on the landscape characteristics of the space.

According to the salient perceptual dimensions, landscape characteristics is one of the three factors that affect the individual preference in landscape (Other two being the personal characteristics and contextual characteristics) and can be identified in two ways; content-based landscape characteristics and spatial configuration characteristics. For the study of the impact of landscape characteristics on the visitor and the residents separately, the spatial configuration landscape characteristics are addressed using three case studies selected from Kandy city; Lake round, Market front and Dalada veediya pedestrian way.

When comparing the effect of spatial configuration characteristics on the visitor and the residents in Lake round, the coherence, legibility and mystery are rated higher by the visitors than the residents. The ratings for the effect of complexity is vice versa. Although the presence of coherence and legibility are identified very highly within the space, while the complexity and the mystery are identified low.

At the Market Front, the responds to the effect of spatial configuration characteristics are different from the Lake round, as only the effect of Legibility is rated highly by the visitors than the residents. The coherence, complexity and mystery have affected comparatively high on the residents. However, the observations of the spaces have identified that the presence of legibility and the mystery is high within the space while the complexity is observed to be very high. Coherence is identified to be low within the site.

Unlike in previous case studies, effect of legibility and mystery is rated comparatively low by the visitors than the residents in Dalada veediya walk way when responding for the effect of spatial configuration characteristics on the preference. Coherence and the complexity are rated comparatively higher by the visitor than the residents. Nevertheless, the presence of complexity and the legibility are identified to be low at the space. However, the mystery is identified very low, while the presence of coherence is high.

To conclude the analysis regarding spatial configuration landscape characteristics, it is vibrant that at spaces where the coherence and legibility highly exist, the effect of those characteristics are rated

comparatively higher by the visitors than residents. The higher and low presence of complexity and mystery within the space have resulted in lower effect on the visitor than the residents, making the moderately presence of complexity affects the visitor comparatively higher than the residents.

This study contributes for the new thinking under the landscape architecture and urban design, making the designers focus on both the residents and visitors landscape preference in urban design. This study also opens up new research needs and potential areas of research that are related to the other characteristics effecting the individual preference in landscape, directing the thinking pattern of the people in the field of Landscape architecture and urban design.

8. References

- Asa Ode, Mari S. Tveit, Gary Fry. (2008). Landscape research. *Capturing landscape visual character using indicators: Touching based with landscape aesthetic theory*, 92-99.
- Berg, Van Den, A. E. (1999). Individual differences in the aesthetic evaluation of natural Landscapes .
- Daniel Kiss, Simon Kretz. (2016). *Theories of Urban Form*. Professorship Kees Christiaanse, Department of Architecture, Network City Landscape, ETH Zurich.
- Fernando, H. R. (2016). Spatial factors that contribute for the leftover spaces in cities: a study with reference to Colombo. 4.
- Karunarathne, A. (2008). *Livable urban public spaces: with special reference to city of Kandy*. University of Moratuwa.
- Kaymaz, I. C. (2012). Landscape Perception. In D. M. Ozyavuz (Ed.), *Landscape Planning* (pp. 256-258). Shanghai, China: InTech.
- Lynch, K. (1960). *The image of the city*. London, England: The M.I.T. Press.
- Min Wang, Bochun Yu. (2012). Landscape characteristic aesthetic structure: Construction of urban landscape characteristic time-spatial pattern based on aesthetic subjects. *Frontiers of Architecture research*, 306.
- Ozyavuz, D. M. (2012). Landscape Perception. In I. C. Kaymaz, *Landscape Planning* (pp. 257-258). Shanghai: InTech China.
- Trancik, R. (1986). *Finding lost space; theories of urban design*. New York: John Wiley and sons.

Samarawickrama, Sumanthri, et al (eds), 2018, "Sustainability for people - envisaging multi disciplinary solution": *Proceedings of the 11th International Conference of Faculty of Architecture Research Unit (FARU), University of Moratuwa, Sri Lanka, December 08, 2018* Galle pp. 292–307. ©

URBAN ALLEYWAYS AS A FUNCTIONAL LANDSCAPE ELEMENT AND ITS EFFECT ON LIVEABLE CITY

A study with reference to Kandy City

GUNARATHNE. C. P. A.¹ & CHANDRASEKARA. D. P.²

Department of Architecture, University of Moratuwa, Moratuwa, Sri Lanka

¹*chathurigunarathe1230@gmail.com*, ²*dpcha@uom.lk*

Abstract

A good city is a fascinating manmade creation which stimulates the physical and psychological satisfaction of its dwellers. Positive public realm is the core of liveable city. Urban alleyways are one such significant, micro contextual public territory generally located at the core of the city. They are multifunctional and act as linking paths, gathering spaces and commercial spaces. Urban alleyways could also generate negative consequences due to dis-functioning and lost spaces. The heritage city of Kandy in Sri Lanka was selected for the investigation of functionality and liveability of the alleyways. According to the literature survey, "Figure-ground theory" explains the relationship between built fabric and spaces in-between. The study adopted the "Linkage theory" to evaluate the circulation space and spatial connections. Integration, connectivity and intelligibility of alleyways were measured as spatial configuration through Space syntax maps. "Place theory" addresses behavioural patterns of people within public spaces in accordance with the physical and psychological attributes. Psychological satisfaction of people is evaluated concerning the fulfilment of physical attributes. Direct field observation and interviews with city dwellers are done for accurate data. Activity maps are used to evaluate detailed description about the relationship among the location, physical environment and behavioural patterns of people.

The study shows that the behavioural patterns of people in urban alleyways are consequence connected to two paradigms; the impact of spatial configuration and effects of physical & psychological dimensions. Hence, the equilibrium of both paradigms influences the performance of alleyways, the study concluded that positive spatial configuration in equilibrium with affirmative physical & psychological attributes of alleyways, deeply effect the satisfaction of people and the liveability of city.

Keywords: *liveable city, urban alleyways, public realm, psychological attributes, spatial configuration*

1. Introduction

A city is a creation of people for their satisfactory living as an expression of themselves and their ambitions. It provides with an acceptable enchantment for urban living. A city is identifiable with its configuration and structural composition of the city elements. Positive dimensions of the city formation are very significant as it generates a liveable city entity where city dwellers can be found with meaningful associations throughout the public spaces of the city. Thus, positive public spaces can be addressed as the most impressive elements of a liveable city which bind together with the spatial progression of the city users. These public spaces can be divided into two categories as macro contextual public spaces and micro contextual public spaces. Streets and urban squares are concerned as in macro perspective while alleyways, pocket spaces are addressed in micro scale context. Micro contextual public spaces of the city are not planned deliberately as in macro contextual approach. They are formed all over the city generating a readable city form.

When considering the alleyways as a micro contextual city space, they are narrow urban corridors rather than planned streets which confine the movement of city dwellers and very much attached with

the city life. Characteristics and social activities of the urban alleys sustain an interesting and a greater social interaction beyond the planned functionality.

1.1 NEED OF THE STUDY

Natural physical setting of the alleys has a high possibility in generating lost spaces and dysfunctions in the city which can affect a negative public realm. If alleyways generate lost spaces in the city centre, the city can be immensely damaged as alleyways together are vast spaces spreading throughout the compacted city core. Thereby neglected alleyways tend to generate an extreme threat to the public realm of the city. Thus, it is important to investigate the role of alleyways and its physical nature as it tends to stimulate psychological satisfaction of the city dwellers and spatial progression.

1.2 RESEARCH ISSUES

Behavioural patterns of people in urban alleyways are concerned in evaluating positive existence of alleyways. Impacts of physical dimensions, psychological dimensions and spatial configurational factors on human behavioural patterns are addressed in the research problem.

Research questions:

- How do behavioural patterns of people relate to the physical and psychological dimensions of urban alleyways?
- How do behavioural patterns of people relate to the spatial configuration of urban alleyways?

1.3 OBJECTIVES OF THE STUDY

- Study the physical and psychological attributes towards the nature of alleyways.
- Study the spatial configuration of the urban alleyways.
- Investigate the behavioural patterns of city dwellers in urban alleyways with causal factors.
- Evaluate the vital role of alleyways as a resource to the liveable city.

1.4 SCOPE AND LIMITATIONS

The scope of the study is limited to the city of Kandy, which has a unique appearance in the city formation and also unique characteristics as a heritage city. Furthermore, the study area is limited to the core area of the city as the city centre is a significant expanse for a liveable city.

Two commercially oriented alleyways were selected for the case study and the investigation. Evaluated framework is applied on case studies discussing the physical, psychological dimensions and spatial configuration effects on the behavioural patterns of the city dwellers.

2. Liveable city and alleyways

2.1 THE CITY

“Cities are amalgams of buildings and people. They are inhabited settings, from which daily rituals -the mundane and the extraordinary, the random and the staged- derive their validity.” (Kostof, 1991, p. 16)

According to Kostof, the city is a fascinating creation of people for their living satisfactory as an expression of their culture, practices and their ambitiousness. The emergence of the city might be followed back to the initial stage of the civilization where small communities were created. Steadily small communities created villages and step by step evolved in-to larger and larger cities with its transformations.

“City form is three-dimensional composition of physical objects and spaces which can be referred to as volumes and masses of the city.” (Lynch, 1962, p. 110)

Kevin Lynch describes that city formation is a combination of the built fabric and space organized in-between the built environment. Those city elements tightly attached to the city and tend to generate pleasing visual access and long-lasting memory to city dwellers. (Lynch, 1962) According to Lynch there are five constructive elements in the city; paths, edges, districts, nodes and landmarks. These elements exist with strong integration among each other.

2.2 THE LIVABLE CITY

The thought of the liveable city within the Western World started, maybe, with the idea carried by Jane Jacobs regarding the rise and drop of American cities. Jane Jacobs contended about the sense of liveability that emphasizes the character of communities in cities that were getting to be exceptionally unoriginal in nature. (Jacobs, 1961)

Hahlweg (1997) amplifies the meaning of the liveable city to enable people to empower individuals to have a solid life within the city. He appreciates the easy mobility within a liveable city. E. Salzano defines the liveable city as an interference between the past and the future. The liveable city acts as the engrave of history, legacy, and admire the not born yet. (Salzano, 1997) Liveability of a city also imitates a quality that conserves the natural resources regarding the future generations. Entirety, liveability permits us to encounter ourselves as genuine people within the city. (A.Casselati, 1997)

According to the literature expressed by those scholars, Liveable city can be captured with the essence of sustainable city which runs deep throughout the city and the communities.

“Liveability means that we experience ourselves as real persons of the city.” (A.Casselati, 1997)

Casselati describes the city dwellers as a part of the city instead of observers or spectacles of the public realm in the city. Day today lives of the city dwellers fully attached with the specific places of the city. Thus, Figural open domain of the city or the public realm acts as the heart of a liveable city.

2.3 PUBLIC REALM OF THE CITY

“The public realm is, in my view the most important part of our town and cities. It is where the greatest amount of human contact and interaction take place.” (Tibbalds, 1992)

Great, unique public spaces of the cities fortify the esteem to the city image. Positive public spaces of the city tend to create liveability in the city public realm. Those spaces are very significant elements of the city as they interact with the city dwellers directly and make meaningful, liveable picture. Macro contextual public realm of the city acts as outstanding components of the city configuration. Streets and public squares of the city can be identified as basic macro contextual public spaces. (Krier, 1975) In the city, most vital and fascinating public spaces are shaped within micro contextual conditions. Micro contextual public realm is not the kind of deliberately planned zones as macro contextual components. They are created by urban voids which carved out by the built fabric of the city.

“To make a design whole, it is essential that the space created by the building have a positive character. This is difficult to gasp, because in our time urban space has become negative...the left over after buildings are built.” (Christopher Alexander, Sara Ishikawa, Murray Silverstein, 1977)

This statement expresses that the city configuration is made by the macro elements. Urban voids considered as meaningful city entity that directly affects the city liveability. These tiny public spaces addressed in the micro contextual approach can be identified as urban alleyways, pocket spaces and niches etc. which are spread all over the city.

Trancik Roger expresses the lost space or urban voids as leftover spaces created at the base of built fabric, high rise buildings, towers etc. They are lightly composed in the city mosaic and cause to create fascinating intermixture of city functions which tends to generate a liveable city. In the same dimension, these micro elements could create dysfunctions due to improper, negative nature of those spaces. (Trancik, 1986) Therefore, positive dimensions of the micro contextual elements are significant in creating a liveable city.

2.4 ALLEYWAYS OF THE CITY AND ITS FUNCTIONALISM

2.4.1 *What is an alleyway?*

As Christopher Alexander defines, alleyway is highly enclosed, narrowest pathways through the urban built fabric which facilitates the humanistic associations. (Christopher Alexander, 1977) He states that

height of the flanked facades in sides of the alleyway is higher than the width of the narrow path and creates a limited movement and behavioural patterns of city dwellers.

Most crucially alleyways are much needed in urban circulation system which integrate the main road system of the city. Those are created among the built environment and specific boundaries, at times defying regulations of local authority, like building reservations, road reservations, fire gaps and fabricated spaces from housing lots. (Rahder.B., 2010)

Spaces in alleyways are rich in crating social interactions, different kind of functions and communities in such alleyways have created strong groups with a specific subculture. (Paul, 2013)

3. Application of theoretical framework

The origin of the city and the present formation of the city layout is significant character to be addressed in recognizing what fabricate the liveable city. Therefore, Roger Trancik's paradigms for positive urban design are addressed here with respect to more integrated city formation and urban system. As alleyways play a vital role with reference to micro contextual phenomena, idealized urban areas and organic spatial structure is taken into consideration. Therefore, three approaches are applied in research of functionality of urban alleyways in a liveable city. (Trancik, 1986)

3.1 FIGURE GROUND THEORY

Figure-ground theory explains the relationship between built fabric and the spaces in between the built. It expresses left over spaces, circulation spaces and connections among built areas. Solid-void pattern of urban fabric can be analysed clearly through the figure-ground theory. Layer of the built and layer of the void can be evaluated separately. (Trancik, 1986) In the framework of this research, the figure-ground theory is helpful in evaluating the voids between built areas and visualizing the circulation through alleys.

3.2 LINKAGE THEORY

The linkage theory describes the circulation space and streets' spatial linkages throughout the urban fabric. Hierarchical system of the streets in the city represent through the linkage theory more specifically. Dynamic patterns of the roadways play a major role in making the urban formation. (Trancik, 1986) In the framework of this research, Linkage theory is helpful in investigating alleys as a part of the circulation system of the city. As the study focuses on a grid city, it expresses the street system considering the organization of links.

3.3 PLACE THEORY

Place theory addresses the behavioural patterns of people within a physical space. (Trancik, 1986) It is all about identifying a specific space by examining the behavioural patterns of people with respect to the physical environment. It matters what people prefer individually. Different people get different kinds of experiences within the same space, because their preference matter based on what they have experienced in their life, their culture and relationships etc. Same place makes unique picture for any individual person at all.

As alleyways play a vital role in an urban system that guide the patterns of the functionalism and the unique character of the city. This theoretical framework is applied to investigate the alleys' role in a liveable city.

3.4 SPATIAL CONFIGURATION

Spatial configuration can be expressed as a systematic process which discovers the complex relationships among the space, people who experience the specific space and the configurational spatial patterns. (Asyra Ramadanta, Endang Titi Sunarti B. Darjosanjoto, 2012) Those relationships can be

affected physically and also visually in between the space in configuration. Two factors are considered in spatial configuration regarding urban alleyways.

3.4.1 Connectivity

“Connectivity is defined as the number of paths, streets, or nodes directly linked to each individual street or node in the road network.” (Amber Farhana Ferdous, Keith Diaz Moore, Jeffrey M. Burns, 2015)

Connectivity is expressed as the basis of the street system which describes the directly connected spatial units of the network. It is the measurement of the spatial configuration with respect to the city fabric as a whole. When consider with the alleyways, connectivity is a significant factor which describes the linkage of the city circulation system.

3.4.2 Integration

“Integration measures how many turns must be made from a street segment to reach all other street segments in the network, using the shortest paths.” (Amber Farhana Ferdous, Keith Diaz Moore, Jeffrey M. Burns, 2015)

Integration is addressed as a measurement of the urban fabric which describes whether the system is integrated or fragmented. Therefore, alleyways’ contribution for the city integration is discussed through the grid city formation.

3.5 PHYSICAL AND PSYCHOLOGICAL DIMENSIONS

Liveability can be identified through the extreme relationship between the human and the physical environment they used to live.

“It is man who creates and experience sensation of space, and the final product in the perception process in a single sensation- a feeling about that particular place.” (Schulz, 1971)

It describes the human sensation about a particular space totally relates to the psychological aspects in human mind. As it is justifiable psychological dimensions woven together with the visibility of physical environment, human behaviour of the city is very closely linked with the place. It is a strong combination of both physical, psychological attributes and human functions in the city. As urban alleyways are persistence for the city liveability, people’s sensitivity for physical environment of alleyways in relation to psychological attributes are discussed through the research.

Physical attributes → Psychological attributes → Human functions

3.5.1 Psychological dimensions

Sensitivity of people may differ towards the physical environment from one to another. People may prefer different choices in relation to their different attitudes and values. In the book of Urban Design: Streets and squares, the way that Moughtin Cliffs describes Norberg Schulz’s opinion on psychological dimensions denotes three positive fundamental attributes. (Moughtin, 1992, p. 48) It strongly indicates a basic concept on psychological attachment towards physical environment. Alleyways will be addressed through basic notion of psychological attributes.

a. Centre

As Schulz describes in Existence, space and Architecture, Centre can be any kind of community space that are experienced by the people. (Schulz, 1971) It can be varied with different characteristics of the space. At a “Centre”, eyes bound to a specific focusing point which tends to make human sensation a centralized axis.

Regarding alleyways, “Centre” can be any space experienced by the city dwellers throughout the linear pathway of the alley. It makes people tie up into a common focus while making it a unique entity in the city.

b. Enclosure

Enclosure relates to the position of a person within a particular space. Observable physical nature of a specific space, strength of the specific boundary gains a higher recognition in enclosure. (Christopher Alexander, Sara Ishikawa, Murray Silverstein, 1977, p. 87) Alleyways in urban fabric flanked and shaped by built fabric of the city. Enclosure is experienced through the defined boundary demarcations of the alley within its territory. Width of the alley, height of the canyon, textures and colours express the territorial demarcations and affect the psychological needs of city dwellers.

c. Continuity

Continuity determines a direction for behavioural patterns of people. Continuity attaches all the components throughout its linear direction. (Schulz, 1971, p. 22) When one consider the urban alleys, continuity links the differences of the physical environment, from the beginning to the end of the linear pathway. City dwellers follow the rhythmic patterns what they detect through their eyes and found with the psychological continuity throughout the linear arrangement.

3.5.2 Physical dimensions

“A vivid and integrated physical setting, capable of producing a sharp image, plays a social role as well. It can furnish the raw materials, for the symbol and collective memories of group communication.” (Lynch, 1962, p. 4)

Human psychological attributes directly link with their sensation towards the physical environment. Because psychological sensation comes after the detection of the picture through the eyes. Dimensions of the physical environment of the urban alleyways determine the visual wellbeing of the city and also the psychological wellbeing of the people. Therefore, basic physical attributes are addressed with respect to the urban alleyways.

a. Scale

“Urban climatologists see the urban street canyon, defined as the space above the street and between the buildings, as the basic urban unit.” (F.Bourbia, F.Boucheriba, 2010)

Physical dimensions of the alleyways regarding the urban canyon relates to the scale. Volumetric relationship of the space can be identified through different spatial arrangement with respect to the height, width and the length. Most significant geometric scale related to street canyon can be identified as aspect ratio of the alley.

Aspect ratio of alley= (Canyon height(H)) / (Canyon width(W))

b. Order

“First thing first and everything in place.” (Antoniades, 1980, p. 42)

If the components of the space are arranged properly according to “First thing first”, it is accepted that space is “orderly” arranged. Order of the place plays a significant role in making livable cities. When concern with urban alleyways, order means the arrangement of elements along the linear pathway, in a rhythmic, non-conflicting manner while supporting the psychological continuity and the enclosure of the space.

c. Light and shade

“Architecture is the masterly, correct and magnificent play of masses brought together in light. Our eyes are made to see forms in light and shade reveals these forms.” (Corbusier, 1927)

Light and shade plays a vital role in liveable city as they blend with the physical formation and its visual appearance in human. Light changes make different moods in the environment which create senses

with respect to the colours, textures, materials and whole spatial progression. Public routine and gathering spaces like urban alleyways highly demand the positive lighting effects as it directly effect on safety of the people and their psychological attributes.

d. Texture and colour

Colour is a sensitive physical attribute which bring meanings and variety to the city. It is more complicated composing colours and textures in urban public places due it should preferable for the whole public realm. Textures and colours define zones of territorial space by communicating. (Porter, 1997, p. 66) It directly effects the positive spatial progression and mingle firmly with sensation of people. Light and shade also influence the textures and colours in reflecting visual quality.

4. Methodology

The study was carried out according to a deductive approach. Preliminary data were gathered from the literature survey. Theoretical framework was derived through the literature and related theories regarding the subjective area. Physical, psychological attributes and factors addressing spatial configuration regarding human behavioural patterns in alleyways were included in the theoretical framework.

Case studies were selected according to a criterion consists of three supportive fundamentals; Urban canyon of the alley, Street activities priority and Travel mode priority. Two urban alleyways in Kandy city were selected for the scope.

Data collection methodology was completed with several stages. Direct field observation, questionnaire, activity maps and space syntax were the tools used in data gathering process. Randomly selected 15 city dwellers were considered as the sample for questionnaire and interviews from each case study. Physical and psychological attributes were observed in each alley.

Activity maps were used to evaluate detailed description about the relationship among the location, physical environment and behavioural patterns of people. Space syntax was used to analyse the spatial configuration of the alleyways regarding integration and connectivity factors. Space syntax maps and content analysis were compared with activity maps, with respect to evaluate the causal factors for the different kind of behavioural patterns of city dwellers. Conclusions were derived through the findings and discussion of the study.

5. Case studies

Two urban alleyways of the heritage city, Kandy are selected for case studies in consequence basis of case study selection. Case studies were conducted with respect to determining the two hypotheses derived from the research issue.

Hypothesis 01: There is a significant co-relation among physical attributes, psychological attributes and behavioural patterns of people in the alleyway.

Hypothesis 02: There is a significant impact of spatial configuration of alleyways on human behavioural pattern.

4.1 CASE STUDY 01- STUDY OF CASTLE LANE

Castle lane is a leading commercial street laid, dividing a block of the grid city. It is a pedestrian dominant linear pathway, mostly acts as a connecting linkage between 2 major streets of the city. The lane can be identified as a clear urban void in the middle of a solid urban block. When we consider the morphological characteristics of the Castle lane with respect to the configuration, there are several public places, landmarks are surrounded.



Figure 39: Castle lane

Castle lane is a wide alley mostly used as a shortcut. Shopping also can be considered as a main activity in the lane. City dwellers also use the alley to get a release from traffic congested main roads. Three-wheelers and motorbikes are allowed through the Castle lane and they make a low speed movement within this pedestrian dominant alley. Some three-wheelers and motorbikes are parked along sides of the alleyway.

Castle lane is always a busy alleyway during the day time throughout the week, except at night time.

4.1.1 Physical and psychological attributes

Scale- Mostly three-storied and four-storied buildings are flanked on either side of the lane which has approximately a width of four meters. Therefore, approximately it is considered as a deep canyon with an approximate aspect ratio of 2.25. Entrances from both ends of the alley are provided with visual and physical access through a void on the continuous building façade. There seem to be a sense of scale even from the entry of alley. As the Castle lane is a comparatively wide alley, people are rarely discomforted due to the façade height. Temporary shades and structures erected by vendors that accommodate human scale also add and synchronize the with the sense of urban canyon.

Order- Castle lane is a linear alley which is bent in several places. Continuous building facades make a balanced arrangement of built fabric. Temporary shades on either side of the street also add to an orderly arrangement. Entrance area of the alley from the Kotugodella Veediya present a somewhat an imbalanced facade character compared to the other areas. Drains are laid along the sides of the paved street. Some disorderly elements are seen in some places such as scattered cables, pipes, wires, street lamp posts and dilapidated walls. Such elements tend to add to unpleasant characters. Street light posts cannot be identified as repeating elements and are scattered through the alley in a somewhat disorderly manner.

Light and shade- When one considers the orientation of the Castle lane, it is an East-West oriented street that is exposed to the sun throughout the year. Therefore, it is always provided with a pleasing, well-lighted, safe and comfortable environment. Colours, textures, materials of the physical setting are clearly visible during the whole entire day. Canopies and temporary shades of shops provide the much-needed shade.

These alleys become dysfunctional and dead during the night. No lights are provided by shops in the night except for the three street lamp posts provided in the lane.

Colour and Texture- Colour is a sensitive physical attribute in the Castle lane that brings variety to the otherwise a boring setting. Building facades on both sides of the alley are flanked with variety of colours as these shops are full of fancy items. Differently coloured sign boards, fancy items in the shops,

temporary shades of the shops, colourful claddings of buildings create the Castle lane a colourful alleyway. However, the somewhat dull walls that exist make a negative impression in the alley.

Floor of the street is identified with a regular texture of its paving material. It is created a pleasant visual quality and a boundary demarcation of the alleyway at the entrances by demarcating the separation from the main roads.

Centre- Within the community pockets near shops and through linear pedestrian path are perceived with centralized sensation due to their physical appearance specifically, comfortable human scale, linear arrangement, continuous and vivid character of facades. Movement of three-wheelers and motorbikes also effects the psychological disturbance for the “centre” mostly at the bent areas.

Enclosure- Enclosure is experienced through the defined boundary demarcations by the building facades of the alley, within its territory. Height of the canyon, textures and colours, paving edge demarcations are expressed the territorial physical demarcations which affect the psychological enclosure of the city dwellers.

Continuity- In the Castle lane, continuity is linked the different components of the physical environment, from the beginning to the end of the linear pathway providing a direction. Composition of the elements along continuous pathway is highly recognized. Rhythmic patterns in the arrangement of these components, their linkage in creating orderly arrangement is affected by the psychological continuity throughout the linear alleyway.

4.1.2 Spatial configuration

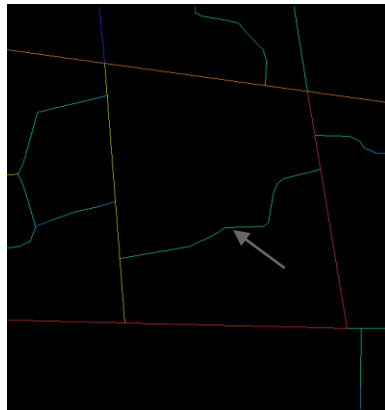

Figure 2: Space syntax

Connectivity- As a directly connected spatial unit of the road network, Castle lane is analysed regarding the number of paths, nodes which connects the road network. According to the syntax map, connectivity of Castle lane is rated with a middle value of the range while expressing light blue in colour. Main streets which are connected to the Castle lane are occupied high values in connectivity. Therefore, Castle lane is recognized as a good contribution to the city circulation system.

Integration- Integration is also recognized in a good level as it is a short path which integrates the city public spaces, main streets and many landmarks in the grid city formation. Mostly the Castle lane is recognized as a contribution to the integration of city fabric instead of contributing to the fragmentation.



Figure 3: Activity map

4.1.3 Activity map analysis

Activity map is expressed at the peak time of 5.30 pm which is recognized with highest number of people in the alley.

Accordingly, activity patterns of the Castle lane are observed by dividing into two user categories. People who walking through the street and waiting in activity pockets near shops are expressed in the activity map. 310 people used the alley within 10 minutes. 110 of them waited in some places through the alley while approximately 200 of them used the alleyway as a thoroughfare street.

Movement speed of city dwellers through alleyway is recognized as very smooth and indulgent behaviour which is expressed through yellow colour. People used to wait for some time in the lane while seeing fancy items.

4.2 CASE STUDY 02- GOOD SHED ALLEYWAY

Good shed alleyway is connected between Peradeniya road and Good shed bus stand confronted S.W.R,D Bandaranaike Mawatha, one of the busiest areas in the city. It is a narrow alleyway with a slope and a stairway next to the good shed Bo tree. Thus, it is identified as a pedestrian alleyway which is constrained the movement of any vehicle due to its natural setting. The area is surrounded by several public spaces and landmarks when considering the physical setting. This is one of the narrowest alleyways in comparison to other alleyways in Kandy. As the street is located connecting the central bus stand of the city and a main road, most of all the city dwellers use the alleyway as a short cut. Otherwise people have to walk a long way to cross between the bus stand and Peradeniya road.



Figure 4: Goodshed alleyway-stairway



Figure 5: Goodshed alleyway

Very fewer commercial activities are found in the alleyway such as, small tea shops, food, small retail shops and one communication centre. People who came for tea shops are recognized as workers of good shed area such as, bus drivers, small shop owners etc. except pedestrians. During the night it is getting less active and dead and dysfunctional. People rarely use the alley in night time.

4.2.1 Physical and psychological attributes

Scale- Good shed alleyway is mostly flanked with two or three-storied building façade and walls. With the slope of the alleyway it tends to appear very tall in façade line and compacted alleyway. Width is recognized as approximately 1.5 meters. Therefore, it is considered as a deep canyon with an approximate aspect ratio of 4.00. Scale factor is recognized which provided with negative physical environment for city dwellers and out of human friendly scale.

Order- Good shed alleyway is a linear alley with less elements. Messy electric cables, pipes, dilapidated walls create a messy, disorderly environment. Floor of the pathway is cement finished with very low or no maintenance. In some places, pathway has become the top cover of a drain. Stairway of the alley is with uneven steps which are broken in most places. Generally, it is recognized as a poorly maintained, neglected alleyway.

Light and shade- Orientation of the Good shed alleyway lane is along North-West, South-East direction. Thus, it does not receive natural sunlight Due to the shade of the blank façade; mostly the narrow alleyway is a dull environment with poor light. Therefore, the Good shed alleyway provides a dull environment even during the noon and one that encouraged crime.

Colour and Texture- A simple variation of colours is seen in the alley due to almost dull and worn away facade. Sign boards and posters of the wall added some colour to the alley. There were none that emphasized the texture of this alley.

Centre- Narrowness of the alley and compacted feeling due to high walls has made the people out of human scale. Surrounding views are blocked and a dull environment prevails therein. Therefore, “centre” attribute is recognized as a negative dimension in Good shed alleyway which discourage the centralized sensation.

Enclosure- Enclosure is experienced through the defined boundary demarcations by the building facades of the narrow alley, within its territory. Fragmentation of continuous path is occurred with the stairway. Uncomfortable scale of the alley, descended pathway, broken stairway is negatively affected on psychological enclosure.

Continuity- In the Good shed alley, continuity of the physical environment, from the beginning to the end of the pathway is provided a direction.

As the alleyway is occupied with a dull, disarranged environment and poor physical setting, rhythmic continuity of human psychology is bit harmed. But as the Good shed alleyway is short in length and narrow in width, mostly the view is focused on the Bo tree which confronted the alleyway from the direction of Good shed. Its directive quality affect positively on human psychology.

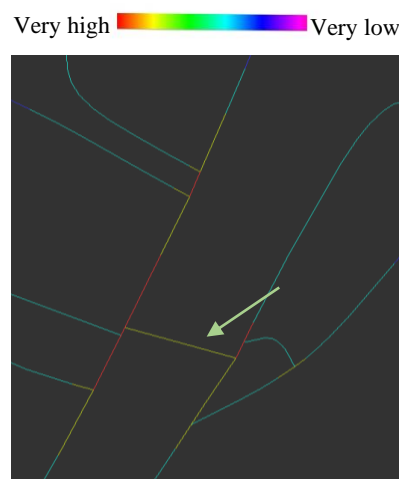

Figure 6: Space syntax

4.2.2 Spatial configuration

Connectivity- According to the syntax map, connectivity of Good shed alleyway is rated with a higher value of the range while expressing yellow in colour. Both ends of the alleyway segment is met with higher connectivity detected roads. In one side the alley is connected to the Peradeniya road which consist of highest connectivity and expressed in red colour. On the other side alleyway is connected to the good shed inner road which also expressed with higher connectivity in yellow colour. Therefore,

Good shed alleyway is recognized as a good contribution to the city circulation system as it consists of higher level of connectivity.



Figure 7: Activity map

Integration- Integration is also recognized in a good level as it is a very short path which integrates the city public spaces, main streets and many landmarks in Kandy city. Mostly Good shed alleyway contributes to the city circulation system through higher integration while emphasizing the connectivity between Peradeniya road and Good shed. Thus, Good shed alleyway is measured as a contribution to the integration of city fabric and less due to its fragmentation.

4.2.3 Activity map analysis of Good shed lane

Activity map is expressed at the peak time of 5.30 pm which is recognized with highest number of people in the alley.

Accordingly, activity patterns of the Good shed lane are observed by dividing into two user categories. People who walk through the street and waiting in activity pockets near shops are expressed in the activity map. 320 people use the alley within 10 minutes. Approximately 25 of them waited in some places through the alley while approximately 295 of them are crossed through the street.

Movement speed of city dwellers through alleyway is recognized as comparatively fast and continuous movement which is expressed through red colour. People do not usually wait for tea or short eats in shops. They do not take time to take a look around while passing through the alleyway.

5. Findings and discussion

Hypothesis 01: There is a significant co-relation among physical attributes, psychological attributes and behavioral patterns of people in the alleyway.

a. Comparison of physical and psychological attributes

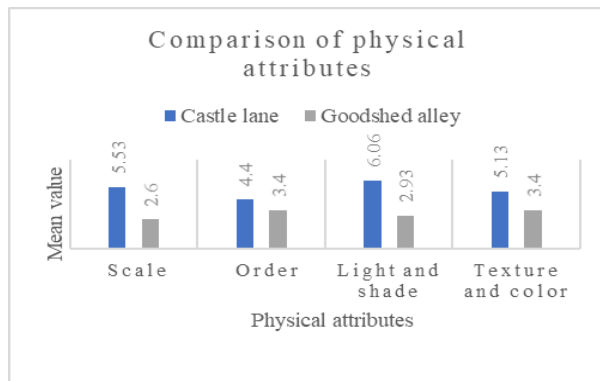

Figure 8: Physical attributes

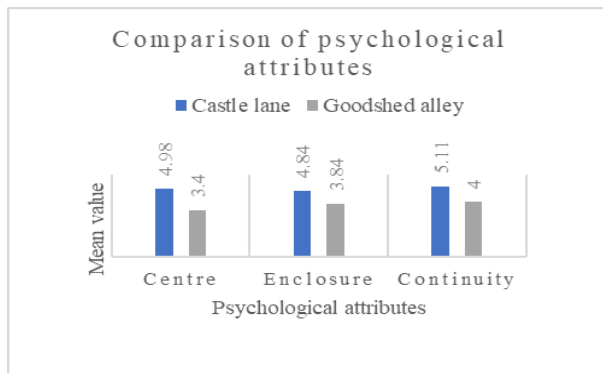

Figure 9: Psychological attributes

Calculated mean value for each physical and psychological attribute taken from the questionnaires of sample city dwellers is expressed through the graphs.

Castle lane is recognized with comparatively higher values in every physical and psychological attribute while Good shed alleyway is rated with lowest values.

According to city dwellers' answers for open ended questions and according to above data, physical attributes of alleyways are recognized as directly affecting on psychological sensation of people. Therefore, positive physical attributes tend to generate positive psychological attributes.

b. Comparison of activity maps

In both alleyways, 5.30pm observation session were identified as busiest time and recorded with approximately same number of people. According to speed of movement, large variations were identified.

Good shed alleyway expresses a continuous fast movement of pedestrians while Castle lane expresses a smooth indulgent behaviour. Significant point derived that with the same count of people in the same time period, the behavioural patterns occur with a considerable difference.

Thus, alleyways with positive physical attributes tend to have smooth, indulgent behaviour while alleyways with negative physical attributes create an expedite, continuous behaviour of city dwellers.

Thus, findings of the study derived that, positive physical and psychological attributes deeply influence the smooth, indulgent behavioural pattern of city dwellers through urban alleyways. Hypothesis 1 is proved through this.

Hypothesis 2: There is a significant impact of spatial configuration of alleyways on human behavioural pattern.

Spatial configuration is measured by connectivity and integration. Space syntax maps were evaluated through the software. Highest integration and connectivity were recognized in good shed alleyway and surrounded Main Street rather than the Castle lane.

Activity maps were compared with space syntax maps to evaluate the co-relation between spatial configuration and behavioural pattern of people. In the good shed alleyway people are used to move fast. In the Castle lane movement of people were recognized as smooth behaviour compared to Good shed alley.

Directly connected spatial units of the street system encourage the connectivity and synthesis of road segments strengthen the integration of the alleyways and the whole street system. Thus, higher degree of connectivity and integration levels directly effect on positive spatial progression.

It emphasizes the linkage among city spaces and expedite the continuous movement of pedestrians through the alleyways. Thus, Hypothesis 2 is proved.

6. Conclusion

Liveable city life evokes through the fascination of public realm of the city. City dwellers become a part of the city by means of confederate moments of public spaces. Amalgamation of both macro and micro contextual public realm bring forth a positive city entity which determine living satisfactory of people.

Urban alleyways are distinguished as micro contextual public spaces with a unique appearance. They are spread throughout the city fabric and create a linking network among city spaces. They have become functional commercial devices, gathering pockets for people. It turns a severe threat to the liveable city functionalism when such micro contextual element become neglected lost space, due to its micro scale and hidden magnitudes.

In the framework of this research, Figure-ground theory is used to explain the relationship between built fabric and the spaces in between the built. Layer of the built and layer of the voids is clearly recognized with regard to the reviewed city, Kandy. As the study focuses on a grid city, the linkage theory is applied in evaluating the circulation space and streets' spatial linkages. As urban space configuration expresses the quality of urban life and living satisfactory, spatial configuration paradigms are derived from theories and applied in the study. Integration and connectivity are measured by space syntax software in analysing the spatial configuration of the alleyways and street system as a whole.

Place theory is addressed to evaluate the behavioural patterns of people within a physical space. A well-established physical setting of the city public spaces leads to satisfaction of psychological desires of city dwellers. Thus, positive physical and psychological dimensions are derived from related theories and literature in regards to determine the behavioural patterns of people.

Four physical attributes are selected as scale, order, texture and colour, light and shade. Psychological satisfactory is evaluated with respect to the fulfilment of physical attributes. Thus, three psychological attributes are formulated as centre, enclosure and continuity as to investigate the co-relation among physical, psychological and behavioural patterns of people. The analysis of the physical and psychological attributes which affect the human behaviour was entirely carried out with the statistical analysis. Michelson's Participant and non-participant method of direct field observation is used to gather accurate data supportive to statistical data gathered from the city dwellers. Activity mapping is used in recording the behavioural patterns and movement of the city dwellers through alleyways. Activity maps are done for each case study separately and they are expressed the observed frequency of specific activities and movements.

The study attempted to investigate two hypotheses based on research issues.

Hypothesis 01: There is a significant co-relation among physical attributes, psychological attributes and behavioural patterns of people in the alleyway.

Scale, order, colour and texture, light and shade attributes are observed and statistically analysed. Volume of the space which synchronized with human scale, orderly arrangement of components, variety of colours and textures and well-lit environment are evaluated as positive dimensions of physical nature by means of five physical attributes. Existence of positive physical attributes of alleyways are recognized as directly affected on psychological satisfaction of people. Centre, enclosure and continuity factors which means centralized sensation, psychological territoriality and directive linear arrangement are evaluated as positive psychological attributes directly affected by physical attributes.

According to concluded activity maps, Positive psychological attributes are deeply influenced the smooth, indulgent behavioural pattern of city dwellers through urban alleyways. This proves the hypothesis 1.

Hypothesis 2: There is a significant impact of spatial configuration of alleyways on human behavioural pattern.

Directly connected spatial units of the street system encourage the connectivity and synthesis of road segments strengthen the integration of the alleyways and the whole street system. Thus, higher degree of connectivity and integration levels directly effect on positive spatial progression.

It emphasizes the linkage among city spaces and expedite the continuous movement of pedestrians through the alleyways. This proves the hypothesis 2.

Behavioural patterns of people in urban alleyways is a consequence pertaining to two paradigms. Specifically, effect of spatial configuration in alleyways and effect of physical and psychological dimensions. Hence, the equilibrium of both paradigms is influential the living satisfaction of people, any tendency of negativity makes severe impact to the people. Thus, the study concludes that positive spatial configuration is in equilibrium with positive physical and psychological attributes of alleyways, deeply effect the satisfactory living of people which tend to create a liveable city.

Bibliography

- A.Casselati. (1997). The Nature of Livability. *Making Cities Livable. International Making Cities Livable Conferences*. California, USA: Godolier Press.
- Amber Farhana Ferdous, Keith Diaz Moore, Jeffrey M. Burns. (2015, January-December). Neighborhood Integration and Connectivity Predict Cognitive Performance and Decline. *Gerontology & Geriatric Medicine*.
- Antoniades, A. C. (1980). *Architecture and Allied Design: An Environmental Design Perspective*. Kendall/Hunt Publishing Company.
- Asyra Ramadanta, Endang Titi Sunarti B. Darjosanjoto. (2012). Application of Space Syntax as Presentation and Analysis Technique in the Study of Spatial Integration in Contoured Landform . *Journal of Basic and Applied Scientific Research* .
- Christopher Alexander, Sara Ishikawa, Murray Silverstein. (1977). *A Pattern Language: Towns, Buildings, Construction*. California: Oxford University Press.
- Corbusier, L. (1927). *Towards a New Architecture (Vers une Architecture)*. London: John Rodker Publisher.
- F.Bourbia, F.Boucheriba. (2010, February). Impact of street design on urban microclimate for semi arid climate (Constantine). *Renewable Energy*, 35.
- Hahlweg, D. (1997). The City as a family. *17th, International making cities livable conference; 1995; Freiburg, Germany*. Carmel, CA: Gondolier Press.
- Jacobs, J. (1961). *The Death and Life of Great American Cities*. New York: Vintage Books.
- Kostof, S. (1991). *The City Shaped*. London: Thames & Hudson
- Krier, R. (1975). *Urban Space*. London: Rizzoli International Publications.
- Lynch, K. (1962). *The image of the city*. London: The MIT press, Cambridge.
- Moughtin, C. (1992). *Urban Design: Street and Square*. Oxford: Architectural press.
- Paul, S. (2013). *Handbook for Minnesota cities, City regulatory functions*. American Society of Composers, Authors and Publishers
- Porter, T. (1997). *The Architect's eye; Visualization and depiction of space in architecture*. London: Taylor & Francis
- Rahder.B. (2010). When rationality is unreasonable. *Bhúmi, The Planning Research Journal* .
- Salzano, E. (1997). Seven Aims for the Livable City. *Making Cities Livable. International Making Cities Livable Conferences*. California, USA: Godolier Press.
- Schulz, N. (1971). *Existence, space and Architecture*. London: Studio Vista.
- Tibbalds, F. (1992). *Making people-friendly towns: improving the public environment in towns and cities*. UK: Longman group.
- Trancik, R. (1986). *Finding Lost Space: Theories of Urban Design*. New York: Van Nostrand Reinhold Company.

Samarawickrama, Sumanthri, et al (eds), 2018, "Sustainability for people - envisaging multi disciplinary solution": *Proceedings of the 11th International Conference of Faculty of Architecture Research Unit (FARU), University of Moratuwa, Sri Lanka, December 08, 2018* Galle pp. 308–315. ©

APPRAISING THE INFLUENCE OF LANDSCAPE DESIGN ON TRAFFIC GENERATED AIR POLLUTION OF URBAN PARKS

I. RAJAPAKSHA¹ & M. EKANAYAKE²

University of Moratuwa, Moratuwa, Sri Lanka

¹indrika_rajapaksha@ymail.com, ²indrika@uom.lk

Abstract

Urban parks are predominant constituents of an urban design which contributes to enhance the quality of life of city dwellers. Location of an urban park is an important design decision and the Public Outdoor Recreational Space (PORS) standard of Sri Lanka prioritizes the criterion of easy accessibility of park users. As the air pollution levels exaggerates in localities closer to major traffic routes it's vital to appraise the concentration of airborne pollutant levels in roadside parks. This study experimentally investigated roadside park of Independence Square (ISP) and the Water's edge (WEP). Onsite field investigation was performed on a typical weekday and weekend of each park. Traffic induced air pollution levels are interpreted with the ultrafine particle number (PNC) concentration levels amalgamated with the outdoor microclimatic thermal parameters. Results explicitly confirm air pollution levels inside the parks are lower than the roadside. Mean PNC of the core of ISP is 93.4% lesser than the corresponding road. Mean PNC of the core of WEP is 83% lesser than the roadside. Reduction of pollution inside the park is inversely related to Crown volume coverage of trees. Impact of pollution levels on distance from the road closely follows the roadside pollution levels and the distance of high pollution zone is different in both parks. Thus the findings of this study informs far reaching landscape design implications in composition and layouts to promote less polluted roadside urban parks in developing cities of tropics.

Keywords: *Roadside Parks; Landscape design; Ultra-fine particles; Particle number concentration.*

1. Introduction

Urban parks are integral part of an urban fabric, which contributes to enhance the quality of life of urban dwellers. With the burgeoning urban population in developing countries of Asia for next 30 years, tropical urbanization is an appealing global issue. Increasing population densities in the cities of Asia restrict the land availability for urban green spaces and evident for less prioritization of Public Open Recreational Space standards.

This phenomenon is not an exception for megacities in Sri Lanka. Furthermore, the specific criterion on easy accessibility has promoted robust integration of urban green spaces with prominent traffic arteries. With the increasing number of commuting vehicles and considerable slowing down of travel speeds demonstrates higher air pollution levels closer to major traffic routes. Thus informs the importance of understanding the impact of traffic emission air pollution on road side urban green spaces.

Studies on park users exposure to outdoor air pollution is an increasing research attention globally. Few studies have explored outdoor pollution dispersion profiles, exposure modelling and attenuation effect of urban vegetation in cities such as France, Belgium (Berghmans et.al, 2009), Tel-Aviv, Israel (Cohen.et al.2014), Thessaloniki, and Greece (Georgi et al.2006). Available limited research on countries in tropical Asia are Shanghai, China (Shan, Y.et.al. 2011), Hong Kong (Xing,Y.et .al.,2018), Bangalore, India (Vailshery, L. et al.,2013). Moreover a growing interest is evident on adverse health effects on parks users' exposure to traffic emissions (Brugge et al., 2007; Tam et al., 1987; Zhang and Batterman, 2013).

Impact of landscape design of urban parks on air pollution levels has been explored using field measurements and numerical simulations. Parametric studies of China inform urban trees and shrubs could ameliorate air quality by absorbing gaseous pollutant and trapping particulate matter (Beckett et

al., 1998, 2000). Moreover, confirms the pollution levels decreases with the distance from the road (Xing,Y.et .al ,2018).

Research on air pollution is less prioritised in Sri Lanka and no studies have been focused on the impact of traffic generated air pollution on urban open green spaces and its users. Thus, this study experimentally investigated the personal exposure to ultrafine particle concentration levels of adjacent traffic arteries and varying landscaping settings of the most popular urban parks in the Western province of Sri Lanka. Highly populated places of parks were considered in appraising the influence of vegetation characteristics in dispersion of traffic generated air pollution of each park.

2. Experimented Urban Parks

This study was performed in two highly popular urban parks situated in the city of Colombo (6.9° N, 79.8° E) in Western, Sri Lanka. City of Colombo represents the highest population density of the country with 3438 persons/Km² and it is the most congested city due to urban sprawl for economic and employment activities (Dept. census & Statistics, 2012). Moreover 60% of the vehicular fleet in Sri Lanka commute within the Western Province and the annual growth of national vehicular population is 12% (Jayarathne et al., 2015). Thus characterises the status of traffic densities and severity of traffic generated emissions on outdoor air pollution in City of Colombo and its suburbs. Location of the urban parks and its robust integration with adjoining roads are shown in Figure 1. Independence square (ISP) is an historical commemoration park positioned in highly urbanized area of Colombo. The façade landscape design of this park spreads in 2 Hectares with dense vegetation. Water’s Edge Park (WEP) is a suburban wetland in Sri Jayawardhanapura, Kotte. This park contains 12 Hectares of land amalgamated with watershed environment and averagely dense vegetation. Both parks provide facilities for active and passive mode of exercises such as relaxing, walking and jogging.

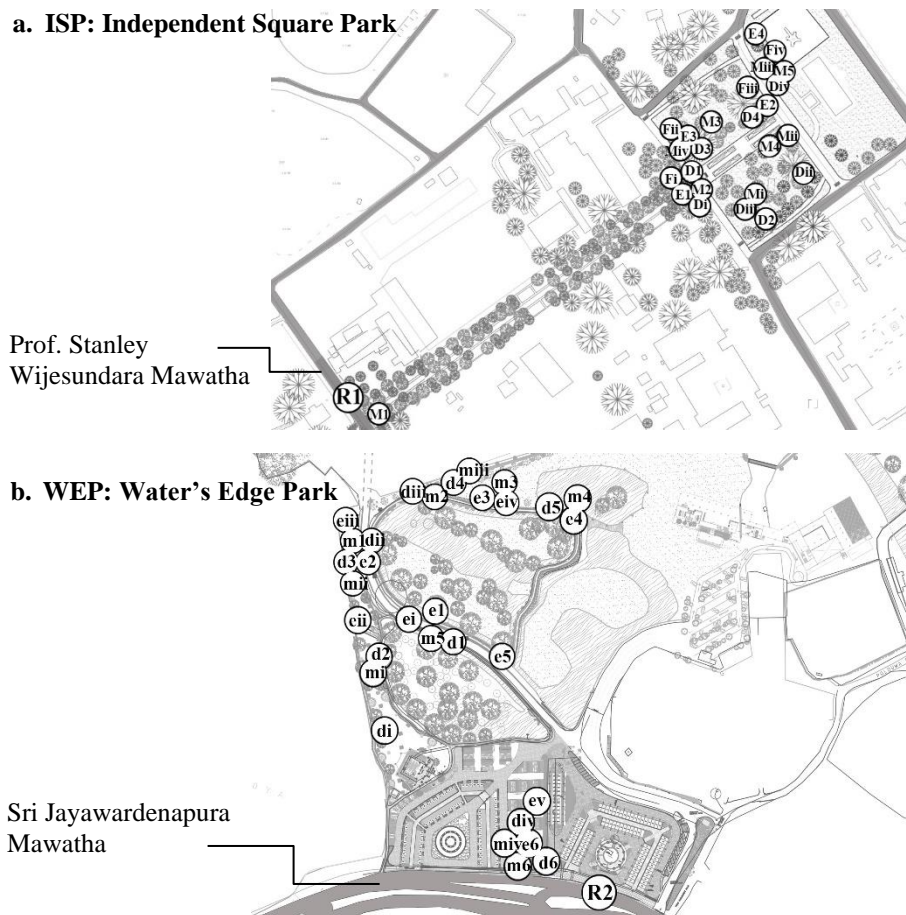

Figure 40, Landscape design including weekday and weekend peak usage profiles of experimental urban parks; (a) ISP (*microclimatic settings of M1 to E4 and Mi to Eiv and roadside measurement point R1*) and (b) WEP (*microclimatic settings of m1 to e6 and mi to ev and roadside measurement point R2*)

2.1 EXPERIMENTAL METHODOLOGY

The experimental methodology of this study is consists of a walk through survey, formulation of a tree inventory and an onsite field experiment to quantify the park users exposure to ultrafine particle concentration levels in varying microclimatic settings of the investigated parks.

2.1.1 Walkthrough survey: Mapping of the peak usage profiles

A walkthrough survey was performed on a typical weekday and weekend during three peak usage time slots such as Morning (M), Daytime (D) and Evening (E). Time periods for morning, daytime and evening are from 8 to 11am, 12 to 3pm and 4 to 6pm respectively. These peak usage profiles represent landscaping settings and park usage profiles of a typical weekday and weekend during the hot summer month of September, 2018 as shown in Figure 1. Figure 1a and b represent 25 and 31 peak usage settings of ISP and WEP respectively.

Table 1 include the details the Park usage profiles of each identified place such as number of park users, its distance from the road and Tree Crown Volume for weekday and weekend of ISP and WEP. Park usage profile of ISP and WEP in a typical week day and weekend consist of 12, 13 and 13, 18 places respectively. Moreover, both figures show peak usage profiles of each park and corresponding data acquisition location on the adjoining road as R1 and R2 in ISP and WEP respectively.

2.1.2 Recording of Landscaping characteristics

Landscaping characteristics of 56 places were recorded by developing tree inventories. This inventory is consists of four main variables of trees such as Species, quantity, height and diameter of the crown (Nowak, 2008). A three dimensional green quantity model was used as an indicator to characterise urban vegetation structure and which is represented as Crown Volume Coverage (CVC).

$$CVC = \text{Total Crown volume (m}^3\text{)} / \text{Surface area (m}^2\text{)} \tag{1}$$

This model considers the geometrical difference of the crown of tree species and combines the diameter (x), height (y) and coverage of the crown to calculate its CVC per unit area (Zhou, 2001). Crown volumes of all inventoried live trees were calculated using equation 1 and the common growth of each tree species was recorded by calculating the mean of diameter Xp and height Yp of the crown.

In addition the normalized crown volume (Vn) and CVC of the tree species were calculated. Total crown volume coverage (CVC) of identified microclimatic settings represents tree species located within 100m² coverage.

Table 1, Identified microclimatic settings of ISP and WEP representing details of peak usage profiles during a typical weekday and weekend (unit for distance: m and TCV: m³)

Day & Time	Independence Square Park ISP				Water's Edge Park WEP			
	Place	Users	Distance	TCV	Place	Users	Distance	TCV
Weekend Morning	M1	10	16.4	82.7	m1	30	322.3	128.6
	M2	20	345.4	202	m2	20	346	175.3
	M3	05	397.3	286.4	m3	40	321	61.6
	M4	10	421.9	151.5	m4	15	303	440.5
	M5	20	362	106.1	m5	08	222.8	186
					m6	50	35	93.8
Daytime	D1	15	345.4	202	d1	35	223.2	164.7
	D2	25	395	106.1	d2	25	267.6	233.5
	D3	10	364.7	329.2	d3	10	359	192
	D4	08	437.8	262	d4	08	378	330.5
					d5	20	325.9	250.4
					d6	40	31	75

Evening	E1	30	345.4	175	e1	20	260.7	214.3
	E2	10	422.9	187.5	e2	50	114.9	183.8
	E3	15	363.4	273.1	e3	90	322	235.6
	E4	15	486.5	31.3	e4	20	293.9	63.6
					e5	30	180	132.6
					e6	95	40.1	112.5
Weekday, Morning	Mi	06	360.4	279.2	mi	10	275.9	164.66
	Mii	05	419.8	133.6	mii	20	339.02	192.23
	Miii	20	477.7	31.3	miii	25	340.89	166.18
	Miv	05				35	32.12	84.375
			359.2	242.7	miv			
Daytime	Di	08	320.4	263.6	di	10	244	212
	Dii	12	431.6	170.4	dii	9	274.3	199.2
	Diii	25	377	97	diii	20	334.8	336.7
	Div	05			div	50	31	103.1
		476.82	171.53					
Evening	Ei	07	340.4	201.6	ei	7	244	106.2
	Eii	08	366.1	90.1	eii	14	274.3	172.7
	Eiii	15	379.3	31.3	eiii	25	334.8	128.6
	Eiv	30	428.6	261.9	eiv	30	314.1	182
	-	-	-	-	ev	40	33.2	131.3

2.1.3 Onsite experimental Investigation: Measurements of personal exposure to Ultrafine particles and microclimate of peak usage settings

Personal exposure to UFP levels were collected by two trained assistants carrying identical backpacks each containing newly calibrated NanoTracer with a sampling tube. Concurrent exposure to UFP was recorded on the road and corresponding microclimatic setting within the park. Sampling protocol was established to collect data for 10 minutes in each microclimatic setting with an acquisition time of 10 seconds. Moreover, microclimatic parameters such as air temperature (T_a), relative humidity (RH), and wind velocity (v) were measured in 56 places of investigated two parks. Prevailing wind direction was obtained from the Google Earth pro 2013.

3. Results and Discussion

3.1 EXPOSURE TO PARTICLE NUMBER CONCENTRATIONS

Park user's exposure to Particle number concentration (PNC) at the reference point on the roads and within microclimatic settings of ISP and WEP was appraised for a typical weekday and weekend.

3.1.1 Independence Square Park (ISP) and adjoining road Figure 2, shows the exposure to PNC levels in peak usage profiles of ISP and on the Sri Jayawardenapura Mawatha during a typical weekend and weekday. Typical weekday is consists of 13 places and (M1 to E4) and weekend represent 12 places (Mi to Eiv). Results explicitly prove exposure to PNC levels of all 25 places of ISP is lower than its corresponding road.

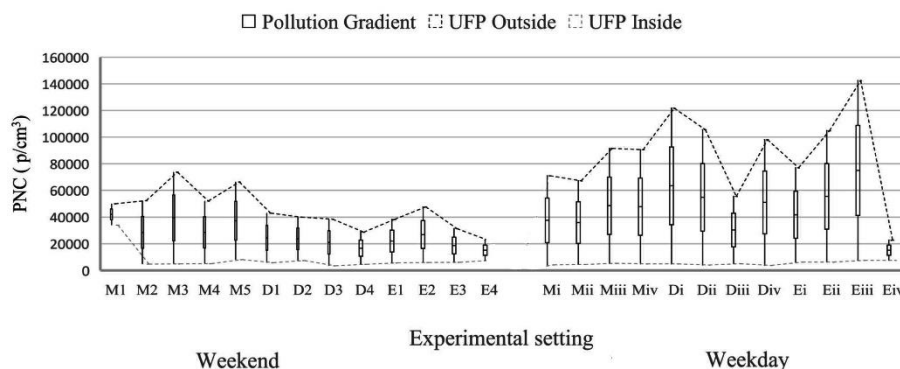

Figure 2, Exposure to PNC levels in ISP and road: Weekday and Weekend

In a typical day of the weekend, exposure to maximum PNC levels of 13 places within the park and adjacent road are 5820 and 98990 particles/cm³ respectively. Similarly, in a typical weekday exposure to maximum PNC levels of 12 places within the park and adjacent road are 3795 and 128246 particles/cm³. Exposure to typical UFP concentration on the pavement of Sri Jayawardenapura Mawatha is high in weekdays than the weekends. Thus informs the exposure to PNC levels in 25 microclimatic settings within a park during a weekend and weekday is 93.4% lesser than the roadside exposure.

3.1.2 Water's Edge Park (WEP) and adjoining road

Park user's exposure to PNC levels of the microclimatic settings of the peak usage profiles of WEP and Sri Jayawardenapura Mawatha during a typical weekend and weekday is shown in Figure 3. Peak usage profile of a typical weekday is consists of 13 Places (mi to ev) and 18 places (m1 to e6) represents the typical weekend. These profiles are categorised into the peak usage settings during morning, daytime and evening time periods.

Maximum PNC levels of the 31 places of WEP are 17576 and 11916 particles/cm³ during a typical day in the weekend and weekday respectively. PNC levels of the adjacent road varies in the range from 49850 to 61975 particles/cm³ during a typical day in the weekend and weekday respectively. Significant difference in exposure to PNC levels is not evident for road side during a typical day in the week and weekend.

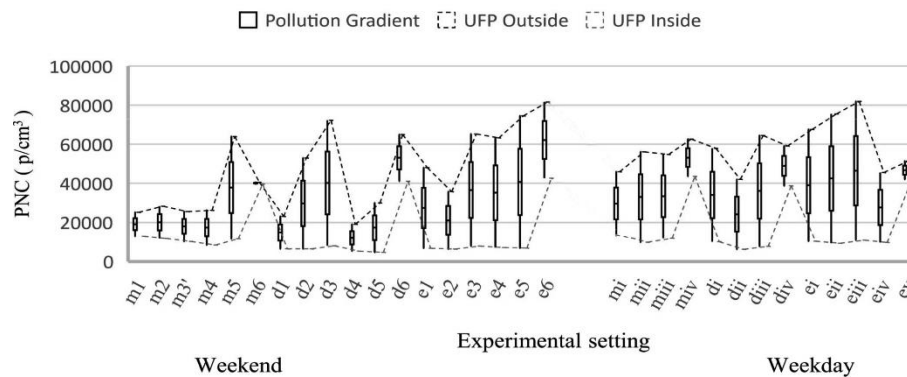

Figure 3, Exposure to PNC levels within WEP and its adjacent road during a typical weekday and day in the weekend

3.2 COEFFICIENT OF VARIANCE OF PARTICLE NUMBER CONCENTRATIONS

Coefficient of Variance and Mean PNC levels during three time periods of a typical weekday and weekend of adjacent road and all places of peak usage profiles of ISP and WEP is given in Table 2.

Table 2, Mean and Coefficient of variation of PNC during three time periods of a typical weekday and weekend of ISP and WEP

		ISPWEM	ISPWED	ISPWEE	ISPWDM	ISPWDD	ISPWDE
Mean (p/cm ³)	Out	58900.51	37509.4	35000.70	80079.2	95231.20	103937.6
	In	11357.88	5339.31	6347.84	4754.98	4466.49	6459.17
CV%	Out	17.86	16.46	30.36	16.0	29.68	27.00
	In	111.8	31.52	13.31	10.79	14.55	12.17
		WEP WEM	WEP WED	WEP WEE	WEP WDM	WEP WDD	WEP WDE
Mean (p/cm ³)	Out	34959.84	43686.94	61386.70	54906.28	55879.34	64403.50
	In	15814.27	12015.67	12932.44	19696.04	15742.63	16480.36
CV%	Out	43.83	51.98	27.67	12.53	17.29	24.13
	In	74.41	119.1	11.25	81.27	98.04	86.73

(WEM: Weekend Morning; WED: Weekend Daytime; WEE: Weekend Evening; WDM: Weekday Morning; WDD: Weekday Daytime; WDE: Weekday Evening)

Mean and the percentage of CV were used as numerical descriptors to analyze the time series dispersion and distribution of PNC levels of ISP and WEP. The statistical indicators show a lesser CV% on roadside in comparison to places within the park. The high CV% measures inside for ISP and WEP evident high exposure levels within the park. Comparatively higher CV is recorded inside the WEP more than the ISP respectively which evident the agglomeration of lower PNC levels to increased PNC levels inside the park precincts. The results highlight the uniqueness of urban parks in attenuation of traffic emitted air pollutants, thus informs the importance of landscape design to mitigate PNC level to maintain lower CV% which will ensure lesser exposure of park users in roadside urban parks.

3.3 INFLUENCE OF LANDSCAPE CHARACTERISTICS ON EXOSURE TO PNC LEVELS

3.3.1 Effect of vegetation cover

Normalized crown volume (Vn) of trees was measured by applying the three-dimensional green quantity model in respective to the tree composition of the identified 56 places of both parks as showed in table 3.

Table 3, Crown volume of 17 common tree species in investigated parks. (CVC- Crown volume Coverage)

Tree Species	3D Geometric Figure	CVC	n	\bar{X} (m)	\bar{Y} (m)	\bar{V} (m ³)
<i>Terminalia arjuna</i>	Oval	$\pi x^2 y / 6$	3	3.5	4.8	30.78
<i>Persea americana</i>	Oval	$\pi x^2 y / 6$	5	3.9	6.3	50.17
<i>Mangifera indica</i>	Oval	$\pi x^2 y / 6$	4	4.1	3.8	33.44
<i>Averrhoa bilimbi</i>	Sphericity	$\pi x^2 y / 6$	6	2.1	4.2	9.69
<i>Roystonea regia</i>	Segment	$\pi (3xy^2 - 2y^3) / 6$	8	3.3	4.3	31.26
<i>Peltophorum pterocarpum</i>	Oval	$\pi x^2 y / 6$	6	6.1	7.2	140.27
<i>Polyalthia longifolia</i>	Cone	$\pi x^2 y / 12$	5	2.8	11.7	24
<i>Plumeria obtusa</i>	Segment	$\pi (3xy^2 - 2y^3) / 6$	8	3.2	4.3	9.68
<i>Millettia pinnata</i>	Oval	$\pi x^2 y / 6$	11	3.2	3.5	18.75
<i>Samanea saman</i>	Sphericity	$\pi x^2 y / 6$	8	10	7.5	196.34
<i>Delonix regia</i>	Segment	$\pi (3xy^2 - 2y^3) / 6$	4	5.3	4.1	77.62
<i>Azadirachta indica</i>	Oval	$\pi x^2 y / 6$	6	4.1	7.1	62.49
<i>Lagerstroemia speciosa</i>	Oval	$\pi x^2 y / 6$	14	3.5	4.3	27.56
<i>Syzygium caryophyllatum</i>	Oval	$\pi x^2 y / 6$	8	3.5	4	25.6
<i>Aegle marmelos</i>	Oval	$\pi x^2 y / 6$	2	4.5	6	63.585
<i>Pagiantha dichotoma</i>	Oval	$\pi x^2 y / 6$	1	2.1	3.5	8.07
<i>Dillenia triquetra</i>	Oval	$\pi x^2 y / 6$	7	5.2	7	99.05

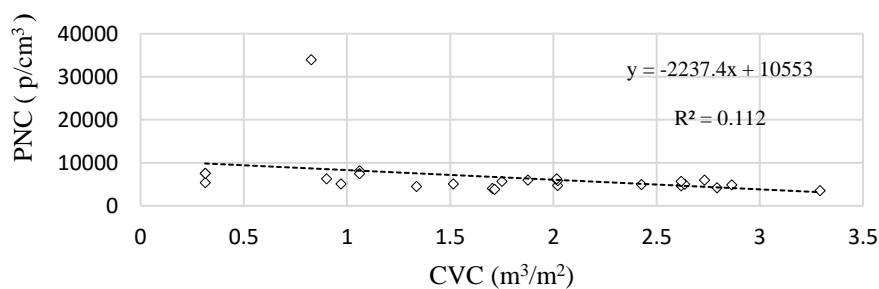

Figure 4, Relationship of CVC and PNC levels for ISP

Figure 4 and 5 show the impact of CVCs on PNC levels in ISP and WEP respectively. Results demonstrate a negative co-relationship between PNC and CVC for both parks.

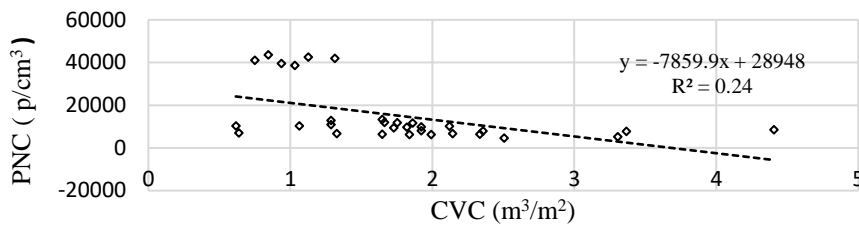

Figure 5, Relationship of CVC and PNC levels for WEP

Results inform an inverse co-relationship between PNC level and measured direct distance from the corresponding location on the adjoining roads of both parks. It is apparent that the PNC levels decreased from a distance of 300m and 100m from the roadside in ISP and WEP respectively. Thus proves less polluted zones of each park is different and informs the need of place specific landscape design strategies to lessen the park users exposure to traffic generated air pollution in roadside parks.

In addition PNC levels of both parks were compared using vegetation characteristics such as calculated tree crown volumes (TCV). Vegetation demonstrates a potential to control dispersion of particles. Thus highlights the importance of an effective layout and vegetation structure to reduce traffic emitted pollution dispersion within the roadside parks.

3.3.2 Distance from the road and exposure to PNC levels

Figure 6 shows the variation of exposure to PNC level in relation to distance for the adjoining road for both parks

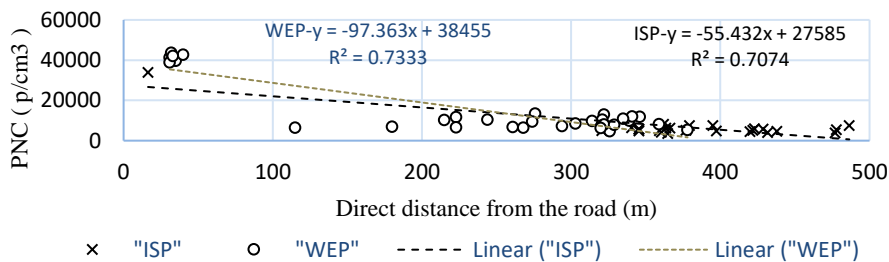

Figure 6, Relationship of distance from the road and PNC levels

3.4 OUTDOOR MICROCLIMATE

Figure 7 shows the relationship between measured microclimatic parameters and PNC levels in relation to an agglomerating correlation matrix. Mean correlation matrix indicate a positive correlation between T and PNC level ($P > 0$). A moderate inverse correlation was observed between PNC count and the RH and V ($P < 0$). In WEP the correlation matrix shows steady fluctuation comparing to the ISP. Thus, the results inform differences in co-relation of microclimatic parameters and PNC levels.

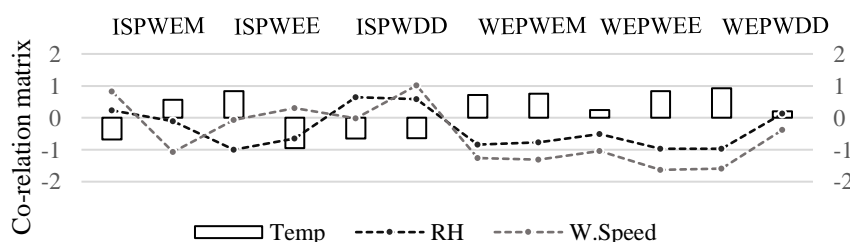

Figure 7, Correlation matrix for PNC varying with T, RH and V

Thus, this preliminary investigation shows the potential of landscape design in generating varying thermal microclimate to mitigate traffic generated PNC levels within the parks and exposure of park users.

4. Conclusion

Influence of landscape design on traffic generated air pollution of roadside urban parks of Independence Square (ISP) and Water's Edge (WEP) were explored in this study. Peak usage profiles of the parks identified 56 microclimatic settings for both parks. An onsite experimental investigation was conducted to measure park users exposure to Particle Number Concentration of Ultrafine particles and microclimatic parameters. Moreover characteristics of vegetation were recorded to evaluate the effect of landscape designs of the urban green spaces.

Dispersion profile of traffic generated air pollution is comparatively less than the adjoining roads thus prove the potential influence of urban green spaces in reduction of outdoor air pollution. Mean PNC levels within the parks were 80 to 90% lesser than roadside. It's evident that the pollution levels inside the suburban park of WEP is higher than the urban park of ISP which controlled by different vegetation coverage. Furthermore, mean CVC of parks confirms the air pollution reduction levels of both parks.

Significance of thermal microclimates in PNC levels demonstrates the landscape design generates microclimatic diversities which influences in reduction of traffic generated air pollution within the park. Thus, the study informs far reaching landscaping design implication on vegetation structure and its morphology in promoting healthy open green spaces in urban settings.

5. Acknowledgment

This research was funded by the SRC/ST/2018/23 grant of the Senate Research Council, University of Moratuwa

6. References

- Beckett, K.P., Freer-Smith, P.H., Taylor, G., 1998. Urban woodlands: their role in reducing the effects of particulate pollution. *Environmental Pollution* 9, 347e360.
- Berghmans et.al, 2009. Exposure assessment of a cyclist to PM₁₀ and ultrafine particles. *Sci.Total Environ.* 407(4):1286-98
- Brugge, D. Durant, J.L., Rioux, C., 2007. Near-highway pollutants in motor vehicle exhaust: a review of epidemiologic evidence of cardiac and pulmonary health risks. *Environment Health* 6.
- Cohen P., Potchter, O., Schnell, I., 2014. The impact of an urban park on air pollution and noise levels in the Mediterranean city of Tel-Aviv, Israel. *Sci.Total Environ.* 195 Pages 73-83
- Department of census & Statistics, 2012. Census of Population and Housing 2012 Sri Lanka - Final Report
- Georgi, N., Zafiriadis K., 2006. The impact of park trees on microclimate in urban areas. *Urban Ecosystems.* 9, pp 195-209
- Jayarathne, R., Jayawardhane, N. Premasiri, H., Rajapaksha, K., 2015. Air pollution levels in major urban cities in the Western Province in Sri Lanka. NBRO - Innovation for Resilient Environment.
- Nowak, D.J., 2008. Assessing urban forest structure: summary and conclusions. *Arboriculture & Urban Forestry* 34, 391e392.
- Shan, Y., Shen, Z., Zhou, P., Zou, X., Che, S., Wang, W., 2011. Quantifying air pollution attenuation within urban parks: An experimental approach in Shanghai, China: *Environmental Pollution.* 159 pg., 2155-2163
- Tam, N.F.Y., Liu, W.K., Wong, M.H., Wong, Y.S., 1987. Heavy metal pollution in roadside urban parks and gardens in Hong Kong. *Sci. Total Environ.*
- Vailshery, L., Jaganmohan, M., Nagendra, H., 2013. Effect of street trees on microclimate and air pollution in a tropical city. *Urban Forestry & Urban Greening.* 12 pg. 408-415
- Xing, Y., Brimblecombe, P., 2018. Dispersion of traffic derived air pollutants into urban parks. *Sci.Total Environ.* pg. 576-583
- Zhang, K., Batterman, S., 2013. Air pollution and health risks due to vehicle traffic. *Sci.Total Environ.* 450:307-316.
- Zhou, Y., Zhou, J.H., 2001. The urban eco-environmental estimation system based on 3-dimension crown volume. *Chinese Landscape Architecture* 5, 77e79.

Samarawickrama, Sumanthri, et al (eds), 2018, "Sustainability for people - envisaging multi disciplinary solution": *Proceedings of the 11th International Conference of Faculty of Architecture Research Unit (FARU), University of Moratuwa, Sri Lanka, December 08, 2018* Galle pp. 316–324. ©

LATE COLONIAL PERIOD MERCHANT HOUSES AT BIRULIA: A STUDY ON ARCHITECTURAL FEATURES

ADNAN. ENAM RABBI¹, & ISLAM, TAZRIN²

¹University of Asia Pacific, Dhaka, Bangladesh

²Military Institute of Science & Technology, Dhaka, Bangladesh

¹enamrabbi@uap-bd.edu, ²124archo801030@gmail.com

Abstract

Bangladesh is rich in its unique culture and heritage, latent in its architecture and settlements. Facing challenges and struggles to be a global capital, the 400-year-old city - Dhaka seeks its historical identity amongst a diverse range of political reigns and socio-cultural influences. Birulia, being a century-old settlement at the brink of Dhaka is historically important as a witness to the uprising of the middle-class elite (Merchants) of the late 18th Century. Biruila was a vivacious business center, important river port as well as a sacred place for Hindu religion during the regime of Vawal king. At the end of the nineteenth century, local elite Hindu merchants started building houses and temples along a brick-paved road. The form and spatial arrangements of these remaining buildings bear distinct architectural styles of British Colonial Period with a fusion of Mughal Architecture adapted for the local climate and traditional house forms. Due to the lack of proper documentation, conservation plans, and maintenance, unplanned modification, natural weathering and encroachment by the local people; the majority of the heritage buildings are now losing distinct architectural features. The tangible heritage of this settlement is almost unrecorded and needs to be revived as evidence of urbanization and prosperity of this region by taking strategic conservation policy. Before any conservation endeavor, all elements and architectural features need to be documented properly. The paper will discuss mainly the architectural features (spatial form, zoning) and elements used at the façade of the remaining significant buildings. Based on the documentation, this paper will analyze to find the links between the traditional zamindar house forms and the Birulia buildings at the late colonial era.

Keywords: *Birulia, Heritage Conservation, Zamindar Houses, Architectural Features*

1. Introduction

Bangladesh is a country with a lot of architectural heritage of different periods. The Socio-Cultural, Political and Economic aspects of different regimes influenced the architecture, and Climatic and Physical factors determined the variations in architectural styles and forms, layout, exterior, and interior facade ornamentations, the material used etc in these buildings. It is also rich with building art of the indigenous craftsmen and the influence of different mighty Hindu & Muslim rulers from time to time. However, it took a different turn in the British period in the seventeenth century. The British colonial era influenced the local people to follow colonial culture and social structure where the total paradigm shifted. A process of change had been started and a new feudalistic class was evolved upon the dependent-dominant relationship between the European rulers and the dependent natives. The permanent Settlement Act, 1793 particularly helped building this new class. One of these dependent native classes was merchants of money lending business. They actually did their businesses in and around Dhaka, the then a booming city. The surrounding rivers of Buriganga, Turag, and Balu around the city made it easier for them to communicate. The Merchant class started building their settlements in and around the city. One of these settlements is Birulia, situated at the west bank of the river Turag and was accessible through a landing station (Ghat).

Today many of these buildings are either been abandoned by the original owner due to the partition of 1947 or neglected at the hand of Nature. The remaining architectural evidence was overlooked by the scholars and historians. However, Jatindra Mohan Roy mentioned Birulia as a sacred place for the local

Hindu religious community. There were around sixty-four colonial architectural buildings in this settlement (Kabir, 2009). The Hindu merchants left Bangladesh after the partition of India-Pakistan in 1947 and at the time of Liberation war in 1971. At present context, only Twelve buildings of that characteristics have been survived.

Birulia bears the historic significance of architectural magnificence, it is very important to conserve and restore the beauty of this island-like settlement. It is not very far from the capital, and urbanization is grasping the surrounding so abruptly that it is very urgent to protect this area, conserve it and create an opportunity of breathing space for the urban life.

2. Historical Context

Birulia is an eyewitness of Zamindari System in the British colonial period. It was under the reign of Bhawal Zamindars. The Bhawal Zamindars ruled the then Savar, Kaliakair, Barmi, Shripur, Mirpur & Gabtoli. Birulia was a temporary place for them to rule over the area. As it was a famous landing station for an established trade route, the merchants built their residences here. The Haat-bazaars were vibrant with a crowd of merchants and sellers. Rajani Kanto Ghosh, a famous merchant of that time built his palace by the river Turag at Birulia.

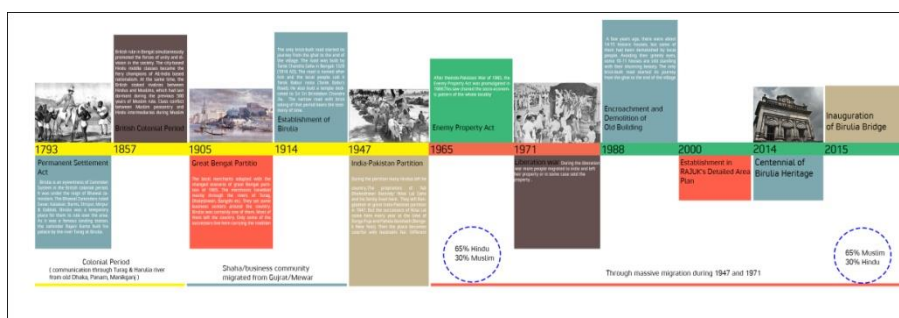

Figure 01, Timeline of Birulia (Source: Author)

Apart from Rajanikanto Ghosh, the other famous family was the Sahas. They created a small settlement of their own. The Sahas are usually known as merchants in Hindu Society. They built their residences along the roadside. Though, their houses were individual but close together like a town having their series of courtyards. Both Bungalows and Courtyard houses were built with the main street at the front side. Among the Saha Family, The proprietors of 'Adi Dhakeshwari Bostraly' Nitai Lal Saha and his family lived here. They worshipped at the temple beneath the Banyan trees of hundred years. They left Bangladesh at great India-Pakistan partition in 1947. But the successors of Nitai Lal Saha come here every year at the time of Durga Puja and Pahela Baishakh (Bengali New Year). Then the place becomes colorful with Baisakhi fair. Different types of manohari elements are sold at that time. In the monsoon, the settlement acts like an island. This settlement becomes separate from the surrounding land in the monsoon and the regains life after the monsoon and becomes vibrant in different religious festivals of the Hindu religion.

A few years ago, there were about 20-21 historic houses, but some of them had been demolished by local people. Avoiding their greedy eyes, some 10-12 houses are still standing with their stunning beauty. The only brick-built road started its journey from the ghat to the end of the village. The road was built by Tarok Chandra Saha in Bengali 1320 (1914 AD). The road is named after him and the local people call it *Tarok Babur Rasta* (Tarok Babu's Road). He also built a temple dedicated to *Sri Sri Brindabon Chandra Jiu*. He also built his house and Guest house along the road named after him. The narrow eight feet road with brick soling of that period bears the testimony of time.

3. Methodology

The architectural remains of Birulia failed to attract the attention of archaeologists and scholars as the inhabitants were not very influential in the socio-political context of that time in Dhaka. There is also a scarcity of written records and proper documentation. In most cases, the original owners dilapidated the houses in the time of India-Pakistan partition in 1947 and liberation war of Bangladesh in 1971. Many of the architectural features have already been damaged or severely threatened by occupational

activities. There were around sixty-four colonial architectural buildings in this settlement. But, at present, there are only twelve buildings contain these architectural motifs. The primary data have been collected through field survey, Building Assessment, Streetscape Assessment, photographic documentation and an open-ended survey among the inhabitants. The data were then compared to secondary data from other colonial structures of traditional house form, especially in the cases of the spatial zoning and arrangements and the architectural elements used at the facade of the buildings.

4. Colonial Architecture in Bengal

The early colonial buildings were executed in neoclassical styles popular in Europe at that time. In Dhaka, these styles were first seen at the churches and later applied on secular buildings. Eventually, by the middle of the colonial period, a new hybrid architecture of Mughal Style and European style architecture evolved. (Rahman, M, 2001). It overlooked the traditional Brick construction, concealing with plasters over it to give a false sense of Stone structure. The new style introduced some foreign elements as semi-circular and segmental arches, triangular pediments over Corinthian, ionic or Doric columns; battlement parapets, traceroid windows, moulded plinths, rusticated walls, and foliated decorative motifs. The decorative elements were transposed from European Architecture and blended in places with local motifs. This hybrid style can be named Indo-Saracenic style which became popular among the powerful people and elites who loved to show their power and affordability. The native *baniyas*, *gomostas*, *dalals*, *pike*, *peyadas* worked as the local agent for the foreign traders. Most of them were high and upper-middle caste Hindus. These new emerging elite class tried to build residences to raise their socio-political status.

Colonial influences led two very distinctive styles of residential buildings- Bungalow type and Mansion Type. The bungalow was the first residential Building Type adopted by the British in Colonial India. Bungalows also integrated many local characteristics like large verandas, which were used as semi-private spaces. The mansion was the other type resulted from colonial influences. By the end of the nineteenth century, many Indians adopted the European lifestyle and imitating the administrative building facades at their homes. Their houses were full of foreign decorative elements.

The secular architecture of Birulia is broadly divided into three categories. They are - single cell house, bungalows and courtyard residences. The bungalow was the first residential pattern chosen by the merchants here. Multiple courtyards have been added in various spaces later in course of time.

4. Morphological Dimension of Birulia

Birulia is located on the west bank of the Turag River and its western boundary was well connected by natural Harulia canal. The landscape was not occupied by any human community before the colonial period. The *Saha* business community who all might have originated from Gujrat or Mewar region occupied this piece of land for business as well as habitation purposes in the early colonial period.

4.1. DISTRIBUTION OF MAHALLAS

Birulia has a total of 320 units of households where 270 households are *pucca* and about 50 households are *Semi pucca*. At present, the entire settlement is divided into several blocks (Mahallas/Paras) depending on its social and professional status (Figure 02).

These are as follows:

- Jele Para* is located in the North-eastern part of the study area.
- Gowala Para* is located in the Eastern part of the study area.
- Muslim/Dakshin Para* is located in the Southern part of the study area.
- Madhya Para* is located in the Middle portion of the study area.
- Shaha Para* is located in the Western part of the study area.
- Uttar Para* is located in the Northern part of the study area.
- Sarkar Para* is located in the outskirts of the main study area.

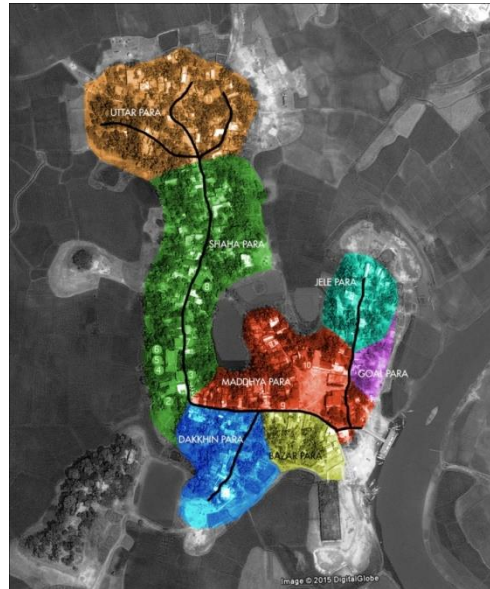

Figure 02, Distribution of the Mahallas (*Source: Author*)

The secular architecture of Birulia is broadly divided into three categories. They are - single cell house, bungalow types and courtyard residences. As it was a small settlement, the additional road was not necessary. Only an eight feet wide and one-kilometer long pathway is seen in the middle of its residential area. Colonial houses among the regular buildings are located on both sides of the pathway. Most of the archaeological buildings of Birulia are located on the south-west corner, mostly in Saha Para of Birulia.

5. The Merchant Houses at Birulia

Elite Saha merchants built their residences at Birulia. Though N. Kabir found Sixty Four Buildings earlier but at present around Twenty buildings survive on the landscape. In this paper, this paper will discuss a few of them. The old buildings are scattered around the settlement. The locations of Houses and Temples are shown in Figure 03.

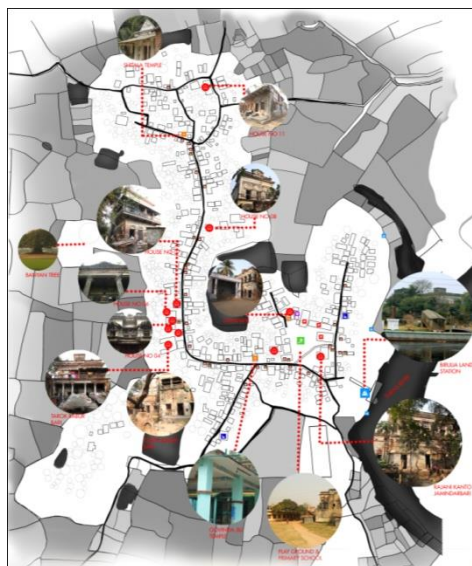

Figure 03, Location of Merchant Houses at Saha Para (*Source: Author*)

There are eleven single storey houses while the other eight houses are two storied. Among them, fifteen buildings are secular in nature and rest of the buildings are used for religious purposes. Some of them are threatened for illegal encroachment and some of them are rebuilt without knowing its archaeological value.

5.1. SINGLE CELL HOUSES

Building no 9, 11(House of Guru Charan Saha) and 15 are single cell houses and were probably used as either an outhouse of the main building or served as office administrative building, storage and public gatherings (Zaman, 2014). These houses are rectangular compartment and places with verandah in front (Figure 4).



Figure 04, Single Cell House (No 11) at Saha Para (Source:

The small-scaled façades of these houses are decorated with arched openings, which are surmounted by rectangular panels (Fig. 5). Raised plinth and veranda have created the transition between the inner house and the street.

5.2. BUNGALOW TYPE HOUSES

The residences of Tarok Chandra Saha (Building 2-Baithak khana), Gopi Chandra Saha (Building 4), Panu Chandra Saha (Building 5 and 6), Nihar Chandra Saha (Building 7) are bungalow type residential buildings. The two-storied residences have a prominent central porch and their front façades are highly decorated with Neo-classical style with a symmetrical plan.

The residences are generally situated by the road and a frontcourt. A layer of inner courts has made the spatial arrangement of the residences compact. Although this type of plan is highly influenced by British cottage, bungalows of Birulia adopted many local characteristics including large verandas and terraces, service and sanitary areas, etc. They enhance the cooking and service area is behind the house plan. (Figure 05)

5.3. COURTYARD HOUSES

The residences of Rajani Kanto Saha (Building no 1), Tarok Chandra Saha (Building No 3), Guru Charan Saha (Building No 12) are the courtyard houses of Birulia. The styles and elements of the front façades are very similar to the façade styles of bungalows. Spatially, they are organized around internal courtyards for functional, practical, socio-cultural and climatic reasons. The inner courts accommodate many informal and semi-private domestic activities. Generally, the private rooms are arranged around the inner courts. Service zone is set behind the house, which is connected with the waterway. The formal or front area is constructed with entrance portico and living rooms express colonial character, but the spatial arrangement of the multiple courtyard house plans show the local sense of privacy especially for women. (Figure 06)

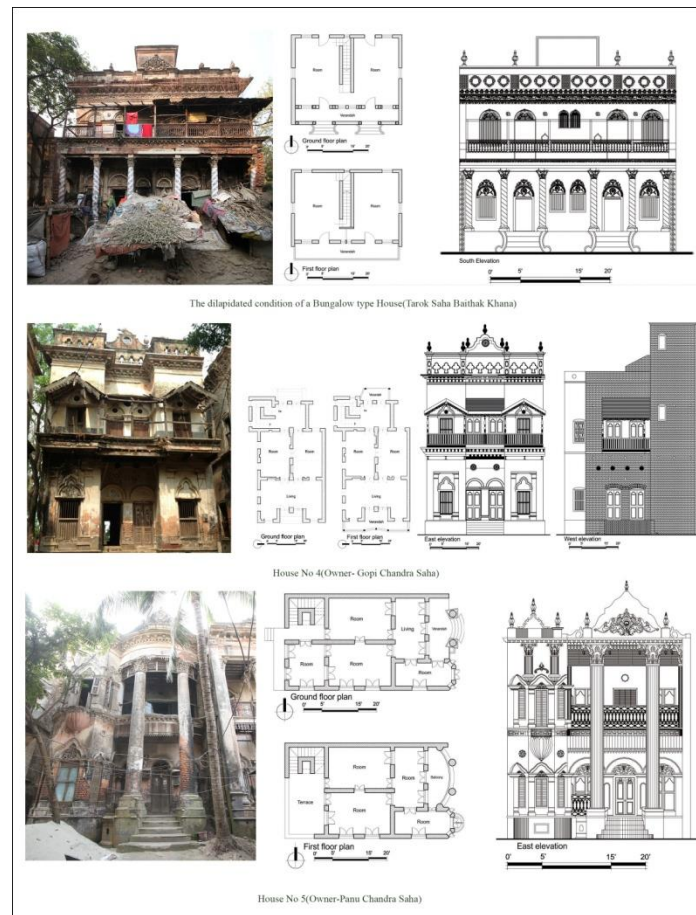

Figure 05, Bungalow Type Houses (Source: Author)

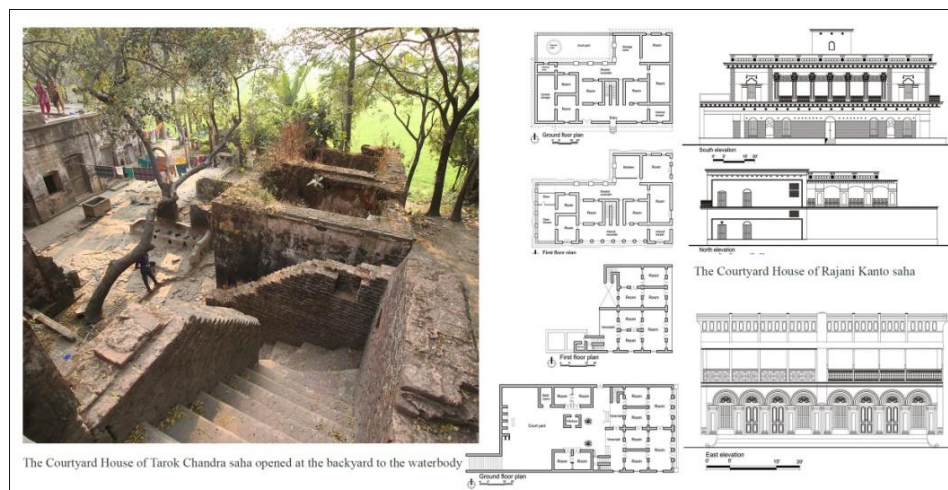

Figure 06, Courtyard Type Houses (Source: Author)

5.3. RELIGIOUS STRUCTURES

Five temples along with *mandapa* can be found in Birulia settlement. These religious edifices represent graceful examples of the European Renaissance style as adopted in Bengal during the colonial period. Radha and Krishna are worshipped at the community temple of Birulia. They are also worshipped inside the houses as well. Some merchants have dedicated their houses in the name of the deities, e.g. Panu Chandra Saha dedicated his house to Radha and Krishna. The written evidence is still evident on the frieze of this building. Worship of Durga (goddess of prosperity) is also a universal festival in Bengal. Nehar Chandra Saha dedicated his house, in the name of Durga. Tulsi is also seen in some houses.

In contrast, few old buildings are loosely structured on the north, east and middle part of the landscape. No residential building of Saha merchants has been found on *Jele Para*. The rich merchants of Birulia during the colonial period selected their residences on the southwest portion of the landscape because it was located in relatively high ground and set on a suitable distance from the community market.

6. Architectural Elements of the Buildings

The Elite houses of the colonial period contain grand and huge columns, decorative arch, different arched openings, pediment, and other decorative elements. These elements are the integrated part of the building's form which is extensively used with a variety of decorations from the early stage of development until the colonial period. As the style matured it became less in volume and quantity.

The walls of the houses are found as load-bearing brick masonry. Usually, the thickness of these walls varies from 15 to 20 inches. Walls are usually finished with lime plaster both inside and outside. The overall color impressions of both interior and exterior walls are white because lime or chuna is used for surface treatment. Stucco and other ornamentations are applied to highlight the surface of the buildings.

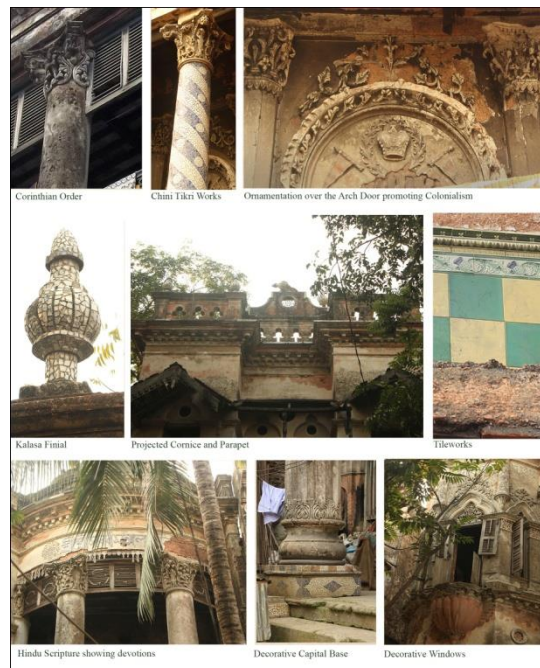

Figure 07, Architectural Elements at Houses (*Source:*

Different types of arches have been used in these houses. The most common types like a semi-circular arch, segmented arch, trefoil arch, multi-cusped arch, and flat arch etc. are found in the study area. Sometimes the exterior elevation is relieved with flat-arched openings. Above the openings, the entablature is mostly decorated with scroll floral and foliage works at the houses of Tarok Chandra Saha and Gopi Chandra Saha.

A variety of column types such as round and square shaped pillar, pilasters, pier, and clustered pier are found in classical character with their full ornamental features, like base, shaft, and capital.

Flat Roof construction system had been introduced during the colonial period where rafters and beams were used to cover the span in the houses. It is popularly known as the *Ganga-Yamuna* system. Generally, the rafters are made of steel I- section joist (Figure 07). The timber purlins are placed upon the rafters to support the roof tiles and lime concrete. The top floor cornice is enclosed with an ornamental parapet wall. Pediment or crest, kalasha finials give the buildings an elegant appearance.

The antiquity buildings of Birulia are basically built on high moulded, arched or niche decorated plinth. Some of the most common are in some cases, the entablature is framed by using flat moulding bands

or rectangular panels treated on the façade. The floor levels are defined externally with projecting cornice. Modillions and dentils are used to support ornate cornices.

Inner houses are also decorated with high-quality ornamental features, for example, most of the floors have colored net cement or mosaic finish. Round shaped ventilators are designed with cast iron floral works which are served on top of the wall surface.

The wooden doors and windows are ornamented with various colors of floral, foliage and geometric patterns. Blind windows and doors under decorative plaster is a common element. The merchants added a great variety of attractive ornamental features, such as cast iron, colored glass, wooden screens, chinitukri, marbles, etc. Cast iron is used to ornate as well as to protect a by the elements like the railings of the veranda, crest, Oculus, ventilators, ceilings, etc.

7. Zoning and Spatial Arrangement

Some of the merchant houses at Birulia contain the concept of zoning which is *kachari* (outhouse) and *andar* (inner house). The *kachari* or *baithak khana* or the outer house are always kept separated both physically and conceptually from the *andar* (inner house). Tarok Chandra Saha house has significantly two buildings for this purpose. The *kachari* or outer house areas are defined as the formal or public part of the house. The courtyard located within this part acts as public courts which possess more accessibility and less privacy. The inner house is identified as the private zone of the contained courtyard houses.

The service court is usually placed at the rear; this follows the layout of the rustic houses surveyed. The backyards are mainly used as services areas. A continuous veranda running around the court set the access primarily from the court to the veranda and secondly veranda to rooms. Stairs are well connected with the verandah for vertical circulation.

Environment and culture clearly influenced the design. The layout pattern of the houses also reflects cultural beliefs and prejudice of the Merchants. Religion and culture have been an integral part of the domestic architecture of Bangladesh. The main religions practiced in this region are Hinduism, Islam, Buddhism, and Jainism. All of which favored the inward, defensive courtyard form in their philosophies of dwelling design.

8. Conclusion

It is apparently evident from the study that, Birulia was once a very vibrant settlement and a witness to the uprising of a merchant class at the late eighteenth century and the beginning of nineteenth-century linked with the socio-political condition of Bengal influenced by the colonial structure and ethos. Though the houses were influenced by European houses, their adaptability in zoning and function turned them into our houses suitable for this climate and context. They are the fusion of occidental form with oriental nature of spaces.

This paper conducted a comprehensive analysis interpreting the merchant houses in their context. The study has its limitations due to the scarcity of documented materials and written history. The original owners left the settlement to the oblivion. Birulia needs attention from the scholars and there is scope for developing conservation restoration, management to rejuvenate the area.

9. Acknowledgments

This paper was developed from the unpublished undergrad thesis of B.Arch program of Bangladesh University of Engineering and Technology in September 2015 and the course Tutors were Professor Dr. Zebun Nasreen Ahmed, Professor Dr. Farida Nilufar, Professor Dr. Md. Ashikur Rahman Joarder, Ar. Patrick D Rozario, Ar. Tasneem Tariq and Ar. Md. Tahajibul Hossain at Department of Architecture, Bangladesh University of Engineering & Technology, Dhaka, Bangladesh.

10. References

Ahmed, B., 2014. *The Adaptive Re-use of Panamnagar*. B.Arch Thesis BRAC University Journal

- Ahmed, I., 2006. *A Participatory Approach to Conservation: Working With Community to Save The Cultural Heritage Of Panamnagar*. BRAC University Journal, (3) 2, 25-33
- Imam, S.R. & Mamoon, M., 1993 *Architectural Conservation in Practice*. Architectural Conservation in Bangladesh, Asiatic Society of Bangladesh, 41-67
- Israt, A. S. 2013 *Zamindar Houses of the Colonial Period: General Delineation of House Form, Spatial Organization and Design Considerations, a Case Study in Dhaka city*, Nakhara: Journal of Environmental Design and Planning, 9, 91-104.
- Mowla, Q.A. Panam Nagar: Conservation and Management for Posterity, 1, 13-15
- Rahman, M. and Haque F.A., 2001. *Multiple Courtyard Mansions of Dhaka: Form and Context*, TDSR Volume XII Number II
- Shaikh, Z.U., 2013. *Architectural Heritage at BIRULLA. Working with Heritage: An Exhibition*, 10–11
- Shaikh, Z.U. & Rahman, M., 2009. *Twenty Five Buildings-frozen museum of Panam Nagar, Old But New, New But Old: Architectural Heritage Conservation*, UNESCO, 280-323
- Zaman, F. 2013 *A study on Archaeological remains of Birulia*. An unpublished M.Phil. thesis submitted to the Department of Archaeology, Jahangirnagar University.

Samarawickrama, Sumanthri, et al (eds), 2018, "Sustainability for people - envisaging multi disciplinary solution": *Proceedings of the 11th International Conference of Faculty of Architecture Research Unit (FARU), University of Moratuwa, Sri Lanka, December 08, 2018* Galle pp. 325-332. ©

IMPLEMENTING BUILDING ENERGY EFFICIENCY RETROFITS (BEER) IN HOTEL BUILDINGS: A CASE STUDY OF SHALLOW RETROFIT

M.F.F. FASNA¹ & SACHIE GUNATILAKE²

University of Moratuwa, Moratuwa, Sri Lanka

¹fasna.fm2013@gmail.com, ²sachie.gunathilake@gmail.com

Abstract

Currently, there is a decisive need around the world to retrofit existing buildings to have higher energy performance. Compared to the significant potential for energy conservation in existing buildings, still the level of implementation of Building Energy Efficiency Retrofits (BEER) is comparatively low. The absence of a clearly defined process for ensuring the delivery of BEER; lack of proactive guidance for project teams to ensure that they make the right decisions to achieve the desired Energy Efficiency (EE) outcomes; and execution of BEER projects in ad hoc basis have been identified as some of the key reasons limiting EE improvements over the long term. Hence, this paper is aimed at developing an initial level decision-making process by incorporating the key decisions to be made and key activities to be performed, during each stage of the BEER decision-making process. The study is limited in its focus to existing hotel buildings, due to their level of energy consumption and potential for conservation. Using a case study, the study derived a total of twelve key decisions to be made and twenty-eight key activities to be performed throughout the decision-making process, based upon which an initial level decision-making process is developed. It is hoped that the findings of this study could facilitate the practitioners in the hotel sector to properly undertake and execute BEER projects.

Keywords: *Building Energy Efficiency Retrofits (BEER); decision-making process; existing hotel buildings.*

1. Introduction

The building stock in the world consumes about 30-40% of the energy (Friege and Chappin, 2014) and releases one third of the total Greenhouse Gas (GHG) emissions (Ruparathna et al., 2016). Since in the building sector, existing buildings encompass the largest segment of the built environment (European Climate Foundation, 2013) and represent the greatest opportunity for Energy Efficiency (EE) improvements (Xing et al., 2011), the enhancement of EE in existing buildings is crucial to attain a timely reduction in global energy usage (Liang et al., 2015; Ma et al., 2012) and GHG emissions (Liang et al., 2015). Within this context, Building Energy Efficiency Retrofits (BEER), provides a useful way to improve the EE of high-energy-consumption buildings (Xu et al., 2015). Simply, BEER are aimed at reducing the operational energy use in buildings through building envelope improvement and mechanical systems upgrades (Xu et al., 2015).

Still existing buildings are slow embrace BEER projects (Friege and Chappin, 2014; Liang et al., 2016), compared to their saving potential (Hendron, 2013). Main reasons for this reduced level of implementation of BEER are: absence of a clearly defined process for ensuring the delivery of BEER, lack of proactive guidance for project teams to ensure that they make the right decisions at the right time to achieve the desired EE outcomes (Gultekin et al., 2014), and execution of BEER projects in ad hoc basis without a systematic decision-making process (Hall, 2014). Hence, it is clear that informed decision-making is crucial for improving the energy performance of existing buildings (Ruparathna et al., 2016) as well as to propagate the benefits of retrofits (Swan and Brown, 2013). In terms of research, however, so far little focus given towards exploring the decision-making aspects of the BEER including the identification of activities to be performed and decisions to be made in the process (Ruparathna et al., 2016). Therefore, this paper is aimed at deriving the key decisions to be made and key activities to be performed in each stage of the BEER projects. The findings are used to propose an initial level decision-making process which could support the effective adoption and implementation of BEER in existing buildings.

Among the existing buildings, this study has limited its focus to hotel buildings due to their level of energy consumption (Sri Lanka Energy Managers Association [SLEMA], 2009; Xu et al., 2013) and saving potential (SLEMA, 2009). Identification of ‘lack of personnel and internal expertise’ as a key reason for many BEER projects to remain unimplemented in existing hotel buildings (Xu and Chan 2011), has insisted the need for a suitable support tool that can be used by the practitioners in the hotel sector in successful adoption and implementation of BEER. Thus, among the available to approaches to implement BEER projects (i.e. led by in-house team or ESCO) (Ma et al., 2012), in this study the focus was limited to in-house led scenario.

2. Decision-making process of BEER

BEER projects should be approached in a systematic manner to achieve maximum benefit out of those projects (Sustainable Energy Authority of Ireland [SEAI], 2015). Despite the existence of large number of BEER decision-making models/tools (Xu et al., 2013), still some authors highlight a lack of systematic process for identifying, determining and implementing BEER projects (Crilly et al., 2012). Similarly, review of literature disclosed that most of the attempts made by the authors so far to derive a systematic approach for BEER projects have resulted in deriving only key stages of the project while only very few have come up with a comprehensive process for BEER projects (for e.g. Ma et al., 2012). This discloses that still there is limited underpinning of decision-making regarding BEER (Friege and Chappin, 2014), which further insist the vitality to come up with decision-making process for the adoption and implementation of BEER projects. Hence, in this level a conceptual decision-making process for BEER projects was developed as shown in Figure 1.

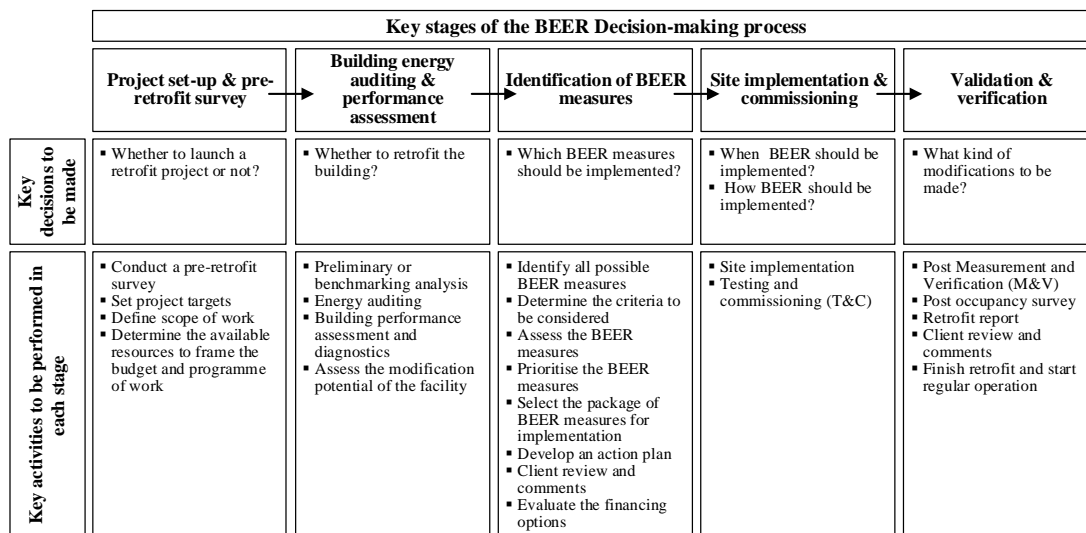

Figure 1: Conceptual decision-making process

Since among the available processes for the adoption and implementation of BEER projects, the process suggested by Ma et al. (2012) appears to cover all the key stages and found to be promising, this same process has been used as the basis for developing the conceptual decision-making process of BEER projects. According to them, the overall process of a building retrofit comprises of five major stages: namely, project setup and pre-retrofit survey; building energy auditing and performance assessment; identify possible retrofit measures or options; site implementation and commissioning; and validation and verification, as depicted in Figure 1.

In the decision-making process of BEER projects, several vital decisions to be made (Zundel and Stieß, 2011) and various activities to be performed (Mondrup et al., 2014). Similarly, the developed conceptual decision-making illustrates both key decisions to be made and key activities to be performed in each of the aforementioned five stages. The activities to be performed under each stage of the BEER project as illustrated in Figure 1 were derived mainly based on the findings of Ma et al. (2012), Hendron (2013), and Mohammadpour et al. (2016), while the decisions to be performed under each stage were elicited

by compiling the findings from Liang et al. (2016), Duah et al. (2014), Ma et al. (2012), and Hendron (2013).

Despite the development of this conceptual decision-making process, still a gap remains as to practicality of this developed process i.e. how these decisions and activities are carried out in practice in the hotel sector, which will be elicited in this study via empirical investigation from an in-house led scenario's perspective.

3. Research methodology

Case study strategy is being selected for this study, wherein the study focused on conducting a single case study, by realising the vitality to spend sufficient time in investigating the decision-making aspects i.e. what decisions were made, and what activities were performed in each stage of the project. During case selection priority was given for the BEER projects that have received the Sri Lanka National Energy Efficiency Awards by believing that such cases would facilitate in deriving the best practices followed by the organisations while retrofitting the facilities.

The selected BEER project for this study was a shallow retrofit project, focused on fine-tuning or improving the management of building's energy systems (i.e. installed VSDs for pumps, motors, blowers in AHU etc., replaced magnetic ballasts with electronic ballasts, replaced incandescent or conventional fluorescent lamps with CFL and LED), and was resulted in energy cost reduction of around 700 – 800 kWh per day.

In total six (06) semi-structured interviews were conducted with the respondents selected on the basis of their level of involvement in the decision-making process of the selected BEER project, which provided good insights into the decisions to be made and activities to be performed in each stage of the process. The details of the respondents are presented in Table 1.

The structure of the interviews intended to facilitate the respondents to specify any details that they considered relevant. Code based content analysis using NVivo computer software was used to analyse the qualitative data collected through semi-structured interviews. During data analysis, each of the interviews were individually coded and analysed under the principles of grounded theory to ensure that the emergent nature of the research was retained.

Table 1: Details of the respondent

Respondent code	Profile of the respondent	Roles played	Years of experience
R1	Chief Engineer	Facilities Manager, Energy Auditor	30
R2	Senior Foreman	Electrical Engineer	36
R3	Foreman	Electrical Engineer	15
R4	Cost Controller	QS/Cost Consultant	08
R5	Chief Technical Advisor- Energy	Industry Institution	25
R6	Assistant Manager	Supplier	05

Findings from the case study analysis are discussed below.

4. Case study analysis

Case study analysis disclosed several key decisions to be made and key activities to be performed in a BEER project led by in-house team. These derived decisions and activities could be fitted within the five stages of BEER decision-making process identified by Ma et al. (2012). Figure 2 presents the proposed initial level decision-making process developed based on case study findings, clearly illustrating: in the first level, twelve (12) key decisions to be made; and in the second level, twenty-eight (28) key activities to be performed during each stage of the process. It is necessary to point out that in

Figure 2, the activities to be performed are presented in the chronological sequence in relation to each stage. The key findings are further discussed in the following sections.

4.1. PROJECT SET-UP AND PRE-RETROFIT SURVEY

This is the initial stage of a BEER project and includes all the activities to be performed in a BEER project to initiate the project. In this case, at first the need of retrofitting was realised by the Facilities Manager (FM) through the routine performance assessment process where energy consumption of the hotel is monitored and evaluated over the past consumption data. This has led him (i.e. FM) to decide ‘whether to launch a retrofit project or not’. Then, the project targets were set based on FM’s rough understanding of the hotel’s saving potential. Afterwards, the parties to be involved in the project were pre-determined along with rough idea on roles that should be performed, as it was perceived that this would be useful in setting up the project team in the subsequent stage.

4.2. BUILDING ENERGY AUDITING AND PERFORMANCE ASSESSMENT

This is the second stage of the process which is focused on clearly identifying the saving potential of the facility with the intention of selecting the suitable systems for retrofitting. In this stage, initially an in-depth audit was conducted by the FM with the intention of clearly identifying the saving potential of the facility. Then by presenting the audit findings, FM has made the top management aware of the need of retrofitting.

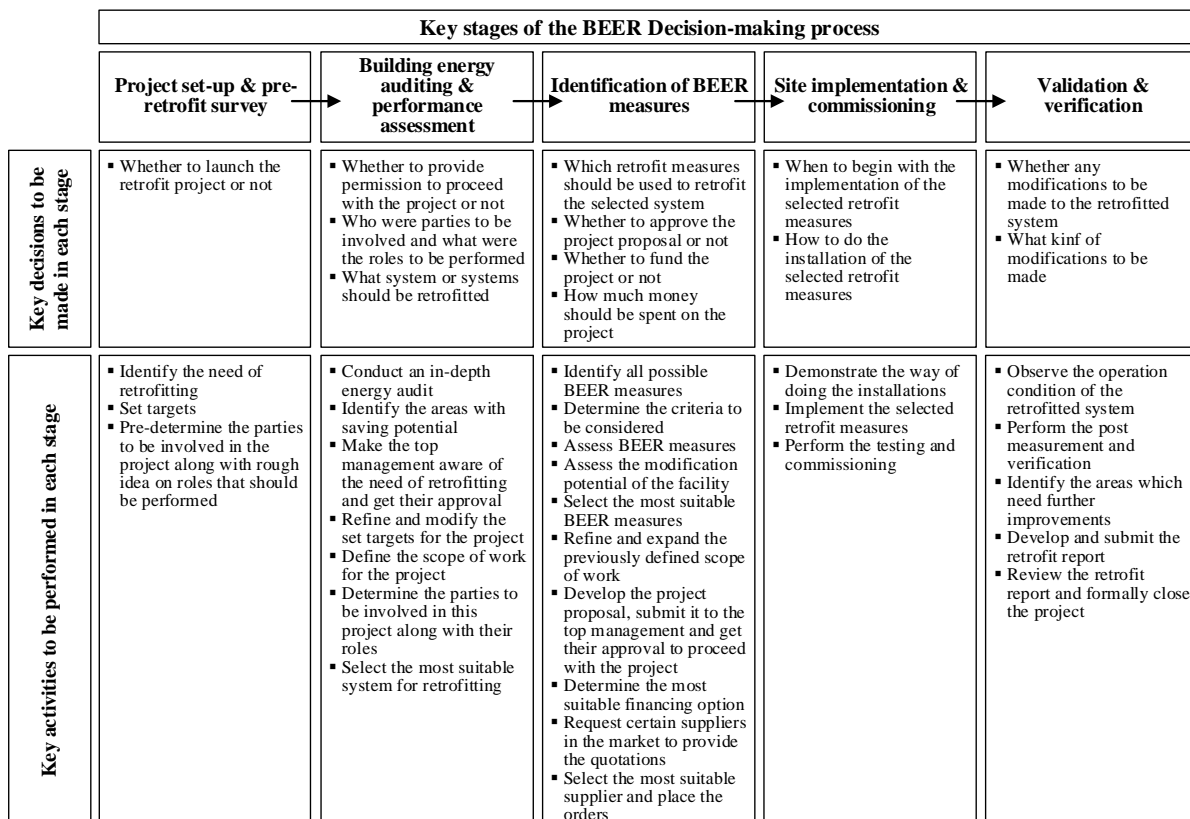

Figure 2: Proposed initial level decision-making process

Findings disclosed that the key decision the top management had to make, mainly after making them aware of the need of retrofitting was ‘whether to provide permission to proceed with the project or not’. Since in this case, a clear saving potential was visible through the audit findings, the top management had granted the approval to proceed with the project. Afterwards, in this case based on the findings of the audit, the set targets were refined and modified. Then the scope of work of the project was defined, based upon which the parties to be involved in the BEER project along with their roles were clearly determined. Respondent R1 had disclosed that ‘who were parties to be involved and what were the roles to be performed’ is a key decision to be made in this stage mainly after defining the scope of work as it facilitates to avoid the ambiguity in the functions to be performed as well as ensure the proper execution

of the tasks. Following this, the parties involved in the project had to finalise their decision with regard to the systems that should be retrofitted. Thus, by considering the level of efficiency of each system in terms energy consumption, each system's contribution to electricity cost, amount of energy cost reduction that could be gained through retrofitting, and impact of each system's operation on guests' comfort, the most suitable system for retrofitting was selected.

4.3. IDENTIFICATION OF BEER MEASURES

This case had the practice of identifying all the possible retrofit measures after selecting the most suitable system for retrofitting. Then these identified retrofit measures were assessed in terms of different criteria i.e. attainable energy saving, needed potential investment cost, payback period, ROI, uncertainty in achieving the predicted level of saving, and time needed for implementation, based on which the most suitable retrofit measures were selected. Afterwards, in this case, the previously defined scope of work was refined and expanded to suit the selected retrofit measures. Then a project proposal was developed mainly including, inter alia, the selected retrofit measures, refined scope work, total budgeted cost for the project, and the key benefits that could be gained through the implementation of selected retrofit measures (i.e. potential saving, emission reduction etc.).

This developed project proposal was then submitted to the top management to obtain their approval wherein the top management had to decide 'whether to approve the project proposal or not', 'whether to fund or not', if yes, 'how much money should be spent on the project' as evident from the case study analysis. Since in this case the top management was very much satisfied with the submitted project proposal mainly the project payback, they had decided to fund the project using internal funds. Afterwards, this case had to select the most suitable supplier for the project for which they have requested the certain suppliers in the market to provide quotations. This was necessitated in this case due to their lack of enough knowledge on the level of credibility of the suppliers. Finally, the orders were placed in a timely manner to avoid project delays.

4.4. SITE IMPLEMENTATION AND COMMISSIONING

In this stage, initially this particular case has made two main decisions i.e. 'when to begin with the implementation' and 'how to do the installations', mainly with the intention of minimising the interruptions caused to the hotel operation or guests. Since the selected BEER project for this study was a shallow retrofit project, adopting measures that are relatively easy to install and have low upfront cost, the respective stakeholders of this case had decided to proceed with the implementation of this project using in-house staff. Since some of the in-house employees did not have enough skills and experience with the implementation of similar systems, the assistance of equipment supplier was obtained where he was involved in demonstrating the way of doing installations to in-house staff.

Then the in-house staff were involved in implementing the selected retrofit measures and subsequently did the Testing and Commissioning (T&C) to ensure the proper functioning of the retrofitted systems.

4.5. VALIDATION AND VERIFICATION

After the successful implementation and commissioning, the FM of the property was involved in observing the operation condition of the retrofitted system to reassure the proper functioning of the retrofitted systems mainly with the intention of minimising the guest complaints. Then, the post Measurement and Verification (M&V) was conducted wherein the project team was involved in: observing the current energy consumption pattern against the previous consumption data; reviewing the project results other than energy conservation and thus determined the level of success of the project. Subsequently, the FM had to decide 'whether any alterations to be made to the retrofitted system' to enhance the performance of the system based on his involvement during the post M&V, and was involved in identifying the areas that need further improvements. Finally, a retrofit report was developed incorporating the project findings, which was in turn reviewed by the top management, and took measures to close the project.

5. Discussion of the findings

Though conducting a pre-retrofit survey to identify the operational problems of the facility is identified as an activity to be performed in the stage of project set-up and pre-retrofit survey (Ma et al., 2012), the analysis disclosed that this activity was not being performed during this particular project as they had a very good understanding on the operational issues of the facility.

Findings revealed that setting targets for the project during this stage was similar to the view of Mohammadpour et al. (2016). Though defining scope of the work is identified as an important activity to be performed in the stage of project set-up and pre-retrofit survey (Ma et al. 2012), in this case the scope of work was defined in the stage of building energy auditing and performance assessment. In literature, determining available resources to frame the budget and programme of work was highlighted (for e.g. Ma et al., 2012), while in practice only the availability of needed manpower to proceed with project was pre-determined in this stage.

Although 'whether the building should be retrofitted or not' is highlighted as a decision to be made in the stage of building energy auditing and performance (Liang et al., 2016; Ma et al., 2012), this decision was not performed by this case, as they had strong commitment and desire to proceed with this project. Hendron (2013) has highlighted that doing a preliminary analysis before an audit, would provide an indication of the total saving potential. However, this was not needed under this case, as they had already realised the saving potential via the routine performance assessment process.

In this case, FM had decided to directly do an in-depth audit rather than doing a walkthrough audit, as he already had a rough understanding on the saving potential and wanted to better capture energy conservation opportunities of the facility in detail. This appears to be align with those of Ma et al. (2012) who disclosed that for a particular retrofit project, the most suitable type of energy audit should be selected based on the amount of details and level of accuracy required.

Though conducting building performance assessment and assessing the modification potential of the facility were identified as activities to be performed in the stage of building energy auditing and performance assessment (Ma et al., 2012), this selected case did not perform these activities. This was because, the chief engineer of the hotel had obtained the required information relating to the performance of the facility through both routine performance assessment process and energy audit which did not necessitated to conduct a building performance assessment. Conversely, it was not required to assess the modification potential as it was a shallow retrofit project and aimed at doing only minor alterations to the existing systems. However, respondent R5 had highlighted the vitality of performing this activity in the attempt of deriving the most suitable retrofit measures. Hence, this was incorporated in the proposed decision-making process (Refer Figure 2).

As per Duah et al. (2014), the most suitable retrofit measures for a BEER project should be determined based on the results of both building performance assessment and energy auditing. Nonetheless, this particular case had selected the most suitable system for retrofitting based on audit results, and afterwards only focus was given towards identifying the suitable retrofit measures.

Though prioritising the BEER measures based on the relevant energy-related and non-energy-related factors (Ma et al., 2012) was identified as an activity to be performed to derive the most suitable BEER measures, no any efforts were taken in this case to perform this activity.

Ma et al. (2012) have put emphasis on the development of an action plan to notify the client about the selected BEER measures. Equally, this particular case had developed a project proposal after determining the suitable BEER measures as well as refining the previously defined scope of work, in which the latter is a novel activity derived through case study analysis. According to Hendron (2013), prior to move on with the implementation of the selected BEER measures, the available sources of financing should be evaluated to determine the most suitable financing option, which was not needed under this case, as it was internally funded.

As has been highlighted by Ma et al. (2012), this case had implemented the selected retrofit measures and had performed the T&C during the stage of site implementation and commissioning. Besides, in

this case prior to begin with the implementation, FM had taken efforts to demonstrate the way of doing the installation to the staff by involving the supplier and thereby disclosed that if an organisation decides to proceed with project implementation using its in-house team, necessary efforts should be taken to provide the required training for the in-house employees by conducting demonstration programmes.

During the validation and verification stage, this case was involved in deciding ‘whether any modifications to be made to the retrofitted system’, and if yes ‘what kind of modifications to be made’ in which the latter was similar to the findings of Hendron (2013).

As per Ma et al. (2012), after the implementation and commissioning, it is crucial to verify the saving from the project by conducting post M&V. Similarly, this activity was performed in this case as well. Analysis disclosed that in this case the FM’s involvement during the performance of post M&V had facilitated him in identifying the areas that may need further improvements, which is parallel to the view of Panthi et al. (2017).

Though the performance of a post occupancy survey is highlighted as a crucial activity in terms of assessing the level of satisfaction of the stakeholders (Ma et al., 2012), no such survey was conducted in this case. As per the authors, after conducting an occupancy survey, a formal report (referred to as retrofit report) should be developed including the key findings of the project that is to be reviewed by the client in turn. Similarly, this particular case was also involved in developing a retrofit report.

As a whole from the above discussions, it is clear that among the derived decisions and activities, some are consistent with the literature findings with varying extent (completely or to some extent), while some are newly derived through the analysis. Besides, some activities highlighted in the literature are not performed in the actual project context (Refer Figure 1 and 2).

6. Conclusions

Aim of this study was to develop an initial level decision-making process to support the effective adoption and implementation of BEER in existing hotel buildings. The research was carried out through the combination of a critical literature review and execution of a case study. Using literature findings, initially a conceptual decision-making process was developed, which was in turn refined based on empirical findings. By employing single in-depth case study, this study derived twelve (12) key decisions to be made and twenty-eight (28) key activities to be performed during each stage of the shallow retrofit project under in-house led scenario (Refer Figure 2). It is hoped that the findings of this study would facilitate the practitioners in effective adoption and implementation of BEER in existing hotel buildings in way an expert might. Further research could be focused on deriving a comprehensive decision-making process for the adoption and implementation of BEER project, by using this developed decision-making process as a basis. Besides, this developed initial decision-making process could also be refined and validated by another case study as a further work.

7. Acknowledgment

This work was supported by the Senate Research Committee of University of Moratuwa, Sri Lanka under Grant SRC/LT/2017/18.

8. References

- Crilly, M., Lemon, M., Wright, A. J., Cook, M. B. and Shaw, D. 2012, *Retrofitting Homes for Energy Efficiency: An Integrated Approach to Innovation in the Low-Carbon Overhaul of UK Social Housing*, Energy & Environment, 23(6-7), 1027-1055
- Duah, D. Y., Ford, K. and Syal, M. 2014, *Expert knowledge elicitation for decision-making in home energy retrofits*, Structural Survey, 32(5), 377-395
- European Climate Foundation. 2013, *Assessing Europe’s Building Stock*, Available from: <https://europeanclimate.org/bpie/>
- Friege, J. and Chappin, E. 2014, *Modelling decisions on energy-efficient renovations: A review*, Renewable and Sustainable Energy Reviews, 39, 196-208

- Gultekin, P., J. Anumba, C. and M. Leicht, R. 2014, *Case study of integrated decision-making for deep energy-efficient retrofits*, International Journal of Energy Sector Management, 8(4), 434-455
- Hall, S. 2014, *Development and initial trial of a tool to enable improved energy & human performance in existing commercial buildings*, Renewable Energy, 67, 109-118.
- Hendron, B. 2013, *Advanced Energy Retrofit Guide Practical Ways to Improve Energy Performance - Grocery stores*. Available from National Renewable Energy Laboratory (NREL) web site: <https://www.nrel.gov/docs/fy13osti/54243.pdf>
- Liang, X., Peng, Y. and Shen, G. Q. 2016, *A game theory based analysis of decision making for green retrofit under different occupancy types*, Journal of Cleaner Production, 137, 1300-1312
- Liang, X., Shen, G. and Guo, L. 2015, *Improving Management of Green Retrofits from a Stakeholder Perspective: A Case Study in China*, International Journal of Environmental Research and Public Health, 12(11), 13823-13842
- Ma, Z., Cooper, P., Daly, D. and Ledo, L. 2012, *Existing building retrofits: Methodology and state-of-the-art*, Energy and Buildings, 55, 889-902
- Mohammadpour, A., Anumba, C. J. and Messner, J. I. 2016, *Integrated Framework for Patient Safety and Energy Efficiency in Healthcare Facilities Retrofit Projects*, Health Environments Research & Design Journal, 9(4), 68-85
- Mondrup, T. F., Karlshøj, J. and Vestergaard, F. 2014, *Building Performance Simulation tools for planning of energy efficiency retrofits in 10th Nordic Symposium on Building Physics* Nordic Symposium on Building Physics, Lund University
- Panthi, K., Das, K. and Abdel-Salam, T. 2017, *Sustainability and cost assessment of coastal vacation homes for energy retrofits*, Built Environment Project and Asset Management, 7(2), 185-198
- Ruparathna, R., Hewage, K. and Sadiq, R. 2016, *Improving the energy efficiency of the existing building stock: A critical review of commercial and institutional buildings*, Renewable and Sustainable Energy Reviews, 53, 1032-1045
- Sri Lanka Energy Managers Association (SLEMA). 2009, *Energy management guide*, Sri Lanka Sustainable Energy Authority
- Sustainable Energy Authority of Ireland (SEAI). June 2015, *Unlocking the Energy Efficiency Opportunity*, Available from <https://www.seai.ie/resources/publications/Unlocking-the-Energy-Efficiency-Opportunity-Summary-for-Policymakers.pdf>
- Swan, W. and Brown, P. 2013, *Retrofitting the Built Environment*, Salford: Wiley
- Xing, Y., Hewitt, N. and Griffiths, P. 2011, *Zero carbon buildings refurbishment—A Hierarchical pathway*, Renewable and Sustainable Energy Reviews, 15(6), 3229-3236
- Xu, P. & Chan, E. H. 2011, June, *Barriers to implementing energy performance contracting (EPC) mechanism into hotel buildings retrofit in china in Management and Innovation for a Sustainable Built Environment MISBE 2011*, Amsterdam, The Netherlands, June 20-23, 2011. CIB, Working Commissions W55, W65, W89, W112; ENHR and AESP
- Xu, P., Chan, E. H. and Lam, P. T. 2013, *A conceptual framework for delivering sustainable building energy efficiency retrofit using the energy performance contracting (EPC) in China*, Journal of Green Building, 8(1), 177-190
- Xu, P., Chan, E. H., Visscher, H. J., Zhang, X. and Wu, Z. 2015, *Sustainable building energy efficiency retrofit for hotel buildings using EPC mechanism in China: analytic Network Process (ANP) approach*, Journal of Cleaner Production, 107, 378-388
- Zundel, S. and Stieß, I. 2011, *Beyond profitability of energy-saving measures—attitudes towards energy saving*, Journal of Consumer Policy, 34(1), 91-105

Samarawickrama, Sumanthri, et al (eds), 2018, "Sustainability for people - envisaging multi disciplinary solution": *Proceedings of the 11th International Conference of Faculty of Architecture Research Unit (FARU), University of Moratuwa, Sri Lanka, December 08, 2018* Galle pp. 333-340. ©

URBAN WATER BODY DEVELOPMENT FOR RECREATIONAL PURPOSES IN SRI LANKA: A comparative study of public perception and willingness to pay

RATNAYAKE. R¹, WICKRAMAARACHCHJI. N² & WATTEGE. P³

¹Department of Town and Country Planning, University of Moratuwa, Katubedda, Sri Lanka

¹rangajeewar@uom.lk, ²naduniwick@gmail.com, ³wattage@port.ac.uk

Abstract

This study explores public perception and their willingness to pay for open water area recreational development in two distinct locations: Diyatha Uyana, Sri Jayewardenepura Kotte and Beach Park, Matara in Sri Lanka. A total number of 600 questionnaire surveys were carried out with users and non-users of the recreational areas in two locations. The monetary value of urban waterfront development was estimated by the Contingent Valuation Method (CVM) using payment card approach. Enjoying peace and relaxation, taking children to play and breath clean air was mentioned as the most important aspects of open water body in Diyatha Uyana area. In Beach Park, the most important activities were chatting or gather with friends and enjoy the natural landscape. More frequent visits occur to enjoy peace and relaxation, breath clean air and enjoy the natural landscape. In both cases, almost all the participants were agreed upon conserving open water body areas in urban settings. Willingness To Pay (WTP) was significantly associated with job and gender in Diyatha Uyana. It yielded a monthly average payment of Rs. Rs.476.93 per month for another five years. In Beach Park, participant's education level, have a child, housing type and time lived in the area were significantly associated with the WTP values. The monthly average WTP was Rs.211.53 per month for another five years. There were 81 zero bids in Diyatha Uyana while the same for Beach Park was 20. The limited budget was the main reason for not willing to pay in Diyatha Uyana. This program was not important to people in Beach Park and it was the reason for not willing to pay. In Sri Lanka, current urban development practice mainly promotes water body development in the Colombo Metropolitan area. The findings of this study argue that water body based planning initiatives are also useful for regional centres and such investments can be justified. Further, this paper is significant as there was no comparative CVM study had been carried on water body development in Sri Lanka.

Keywords. *Urban open recreational area, Valuation of Ecosystem, Willingness to pay*

1. Introduction

Promoting healthy lifestyle practices through city planning techniques has become famous around the globe (De Silva et.al,2017) as more and more concerns raised on decreasing physical activities as a direct cause of health problems. Provide sufficient open spaces for the citizens to engage in physical, social and recreational activities has become an indicator of the livability and the sustainability of a modern city (Chieura, 2004; Jim & Chen, 2006; Ratnayake, 2013; Ratnayake,2017; Butt, A., Ratnayake, R., & Budge, T. (2016). Following the planning concepts of healthy living, Sri Lanka has started the revitalisation of urban water bodies in recent history. Whistle the program gained public attraction and political attention, it lacks studies on estimating the monetary value of urban water body recreational facilities. Valuation of ecosystem services by attaching a monetary value to such services is more effective means of highlighting the importance of these natural resources and also a tool to justify the development projects on a common ground (Hanemann, 1994; Wickramaarachchi, Ratnayake, & Wattage, 2017).

This study aims to assess the monetary value and the willingness to pay (WTP) of users and non users for recently revitalised two open water bodies in two different provinces of Sri Lanka by using the state preference approach. The stated preference research techniques come under the environmental, economic valuation approach and commonly use in estimating the monetary value of non-economic goods such as greenery, water bodies, and parks. In this family of approach, the Contingent Valuation Method (CVM) has been increasingly used in valuing environmental goods (Lo & Jim, 2010; Wickramaarachchi, Ratnayake, & Wattage, 2017) including non-use values (Wattage & Mardle, 2008).

In this study, we have used a comparison of two WTP studies to find out regional differences in preferences over open water bodies using the same questionnaires. This would give us an indication of how utility differences in two distinctive regions would influence the WTP for similar environmental commodities. Both locations are an identical situation of city areas, yet economic activities are somewhat different mainly due to the regional differences.

2. Study areas and Methods

2.1 STUDY LOCATION 1- DIYATHA UYANA, SRI JAYEWARDENEPURA KOTTE

Two study sites have been selected for the purpose of the study: Diyatha Uyana in Sri Jayewardenepura Kotte area (Hereafter known as Diyatha Uyana) and Beach Park in Marata MC area (Hereafter known as Beach Park) in Sri Lanka. Sri Jayewardenepura Kotte (SJK) is the legislative capital of Sri Lanka, located 8km southeast to the commercial capital of Colombo. Currently, a municipality governs and has developed into an urban area featuring a number of urban characteristics. SJK is a planned city with a number of government building including the Parliament of Sri Lanka and ministerial buildings. Despite the urban development of the area, SJK has still contained lagoons, swamps marshy lands and paddy fields. In terms of the demographic characteristics, this municipality has a population of 107,925 living in an area of 17 km². Age distribution of the population shows 70.3% of the population is in 15-64 year age group while 18.3% in 0-14 year age group and 11.4% of the population over 65 of years. The research site of Diyatha Uyana and surrounding areas are situated in SJK. It was established in 2012 under the guidance and close supervision of Urban Development Authority and the Secretary of Defense. The area sits between the Parliament complex and the Diyawannawa Oya. The marshy land on the banks of Diyawannawa Oya has been converted into parks with walking tracks, children's play areas, restaurants and small shops.

“Beach Park” is located in the Matara Municipal Council (MC) area. It is a major regional city on the coast of Southern Province, located 160 km away from the commercial capital of Colombo. It is the main commercial hub and the administrative capital of Matara region. It was gravely affected by the Asian tsunami in December 2004. Matara historically belongs to the area that was known as the Kingdom of Ruhuna, which was one of the three kingdoms in Sri Lanka. In the 16th and 18th centuries, Matara was ruled by the Portuguese and the Dutch respectively. Matara, as the commercial center of Sri Lanka's South, consists of high buildings with many business activities where many reputed companies from Colombo having their branches in the city. Matara's main tourists' attractions are its ramparts, Dutch architecture, a well-preserved fort, its street life and the beach area.

In terms of the demographic characteristics, similar to SJK area, Matara MC area has a population of 114,970. Considering the ethnic identities, Sinhalese are the majority ethnic group with 95% of the population. Age distribution of the population indicates that 65.1% is in 15-64 year group while 24.9% in 0-14 year group and remaining 10.0% is over 65 years. In Matara district total employed population is reported as 281,241. The research site “Beach Park” area has been developed to provide recreation, relaxation, refreshment, entertainment and physical wellness to all visitors irrespective of their sex, age and class. It spans a length of nearly one kilometre and has become a very popular leisure resort at Matara, particularly during weekends and public holidays. Many trip goers including school children and tourists also stop over at this beach park for a break and for partaking of meals.

The comparison of the two parks has used CVM to estimate WTP for preservation and management of the open water body recreational areas in two sites. User and non-user perspectives and attitudes on the development and conservation of open water bodies were also measured. Both studies were used a questionnaire-based approach to assess the economic value of non-market goods. CVM uses three different formats and their variations when eliciting monetary value: Dichotomous choice with and without follow-ups, open-ended, and payment card approach (Venkatachalam, 2004, Wattage & Mardle, 2008). Previously, both dichotomous choice and open-ended payment card approaches have been commonly used in assessing the economic value (Lo & Jim, 2010). However, both methods face practical limitations. The dichotomous method seeks participants' willingness or unwillingness (saying “yes” or “no”) to pay for a chosen amount. Even though this question is easy to understand by the participants, it requires a large sample size and also it restricts having an actual preferred value of the respondents. The open-ended method provides a better variety of participants' preferred value. However, it requires participants' understanding of the bidding system. Payment card approach has been emerged as a hybrid of these two approaches and has been adopted in recent studies (Jim & Chen,

2006). The current study used both open-ended and dichotomous without follow-ups approach.

The design of the questionnaire is important in contingent valuation studies (Tyrvaainen & Vaananen, 1998). The questionnaire starts with a brief introduction explaining the aims of the survey. The first section of the questionnaire explored the respondents' level of participation in different activities in surrounding areas of Diyatha Uyana and Beach Park. First, eight groups of questions seek the importance of open water body for the users and non-users in different activities. Next question recorded the frequency of participation in the above eight activities. Final question under section one explored the challenges when using the open water body. Section two explored respondents' perceptions of conserving open water bodies. The first question asked whether conservation is important for the users and non-users. Next two sets of debriefing questions were used depending on the response to question 4, i.e., *Do you think the conservation of open water body is important to you?* If the answer was yes, they were given a scaling question with eleven statements to rank the importance of conservation of open water bodies. The negative respondents were also given a scaling question with nine statements to rank the negative effects of conserving open water bodies.

The WTP questions started with a hypothetical statement mentioning the reduction of public open spaces in both locations. Respondents were recommended to consider their financial circumstances before filling these questions. The respondents were asked to state their WTP for conservation and development of open water body of a given amount (Rs.1000.00 per month). This amount was selected as an equal average amount of normal monthly fee for a Gymnasium in this area. Then an open-ended question was given to participants to bid their maximum payment. After stating their WTP, positive bidders were presented with an open-ended question to know the motives of their action. Non-positive bidders (Rs 0) were presented another open-ended question to see the rationale behind choosing not to pay for the open water body revitalizing program. The questionnaire ends with 12 questions gleaning respondents' socio-economic characteristics. Such data helped to assertion whether socio-economic status affects the WTP. A total of 600 people were chosen for the survey in both locations. The simple random sampling procedure was used in selecting the sample. Ten university students were recruited to conduct the survey in August 2017 in Diyatha Uyana while the Beach Park study was conducted in July 2018. The survey was carried out on the site and also at neighbourhood houses. The data were analyzed using SPSS software. Linear regression models were constructed to identify the factors associated with the stated WTP.

3. Results

3.1 SOCIOECONOMIC CHARACTERISTICS OF RESPONDENTS

A total number of 600 questionnaires were completed by face to face interviews or by the respondents themselves in both locations. Socio-economic profile shows the variation of participants of the study. This may have some impact on the stated WTP values. Reflecting the Age difference of the sample, more than fifty percent of the respondents of the Beach Park was under 30 years bracket while more than sixty percent of Diyatha Uyana respondents were in 30-40 age group. In terms of income, nearly half of the participants fall within the Rs 50,000-100,000 monthly income bracket in Diyatha Uyana, but in Beach Park, it reduces to 9.2 percent.

3.2 IMPORTANCE AND CHALLENGES OF THE USE OF URBAN WATER BODIES

The survey gathered information on the importance of open water bodies, the frequency of uses and challenges faced by users and non-users. In general, visits to open water bodies are prompted by different activities. Participants were asked to rank the importance of the open water body against nine statements on a Likert scale. The aggregate score is calculated by summing the weights given starting from -2 for strongly disagree, - 1 for disagree, 0 for neither agree or disagree, 1 for agree and 2 for strongly agree. The results show the differentiation of the perspectives on the importance of the open water body in the two different locations. Provide peace and relaxation ranked as the most important aspect of the open water body among Diyatha Uyana participants, chat or being with friends was ranked as the highest important aspect in Beach Park (*Table 1*). Chat or gather with friends was ranked as the 6th at Diyatha Uyana may reflect the very busy lifestyle in the area and also may reflect the less social interactions among the urban dwellers. Exercise or stroll was the second most important activity at Beach Park, which is one of the major objectives of the developing these parks. Moreover, lack of such facilities can be observed in outside the Colombo. Take children to playgroup is the next important activity which is obvious due to the lack of such facilities in the area. Lastly, biking was least important

at both locations. Biking may be a good exercise, however, the lack of infrastructure and the danger of riding in main roads prevent people using them.

Table 1 The importance of open water body in Diyatha Uyana and Beach Park

Categories	DU		BP	
	Score	Rank	Score	Rank
Exercise or stroll	114.4	4	88.7	2
Breath clean air	115.4	3	86.8	4
Chat or gather with friends	98.3	6	118.7	1
Take children to play group	126.4	2	87.7	3
Biking	-63	9	10.4	9
While away time	67.7	8	79.6	5
Enjoy the natural landscape	97.3	5	56.1	8
Add an economic value to the area	73.4	7	73.7	6
Enjoy the peace and relaxation	148.6	1	69.0	7

Most frequent visits were happened to enjoy the peace and relaxation, breath clean air and to enjoy the natural landscape in Diyatha Uyana (*Table 2*). This reflects the users and non-users desire for tranquillity in the middle of the busy urban lifestyle. However, most frequent visits were happened to chat or gather with friends, enjoy the natural landscape and while away time in Beach Park. While the enjoy peace and relaxation was the top-ranked participating activity in Diyatha Uyana, it was ranked as the second least participated activity in the Beach Park. This may be due to the difference of the lifestyles of the two selected locations.

Table 2 How often do you participate in the following activities – Diyatha Uyana and Beach Park

Categories	DU		BP	
	Score	Rank	Score	Rank
Exercise or stroll	184.2	4	162.7	5
Breath clean air	196.6	2	157	6
Chat or gather with friends	169.7	6	214.9	1
Take children to playgroup	179.2	5	162.9	4
Biking	34	8	90.5	8
While away time	159.9	7	164.6	3
Enjoy the natural landscape	185.6	3	185.6	2
Enjoy the peace and relaxation	220.8	1	151.3	7

The study is also analyzed information on the challenges of using Diyatha Uyana and Beach Park. This knowledge could be used to inform park designing and planning authorities to overcome existing weaknesses of this and similar parks. Inadequate parking spaces (28.3%) and sporting facilities (26%) were the most mentioned difficulties faced by participants in Diyatha Uyana. Too far from home (44.8) and the inadequate seats (42.7) were the major challenges faced by the sample population in the Beach Park. The findings of this study can be useful in proposing open water body development in urban areas to develop, as some (44.8%) mentioned that the Beach Park is too far from home. People tend to travel some distances to visit the Beach Park. Another key challenge is finding a suitable parking space (28%) in Diyatha Uyana, which could have avoided if it was considered at the planning stage of the park.

Under the *other* category, around 38 % of participants have mentioned issues related to the maintenance as an obstacle in using Diyatha Uyana. Fewer trees (27%), poor sanitation facilities (19%) and lack of shade (7%) were the most mentioned issues under other categories. Public concern about their safety has to take into consideration as it was mentioned few times under the other category. Some people indicated their concern about gang behaviours, drug problems as a primary concern on their security. Too many people, inadequate lighting and sports facilities are among the few challenges faced by the users in the Beach Park.

3.3 CONSERVATION OF OPEN WATER BODY

The survey seeks respondents' attitudes towards conserving open water bodies in urban areas. Almost all the participants (99%) agreed upon the conservation of open water body areas in their neighbourhood in Diyatha Uyana. The motivations behind their attitudes were measured using eleven debriefing questions as shown in *Table 3*. In Diyatha Uyana, people have encouraged outdoor activities and allowing more contact with nature. This indicates that people seek more places for outdoor activities and to contact with nature to relax in the midst of their busy lifestyles. Many respondents were encouraged to save open areas thinking on environmental benefits.

Table 3 Importance of conservation in Diyatha Uyana and Beach Park

Categories	DU		BP	
	Score	Rank	Score	Rank
Encourage outdoor activities	326.4	1	282.9	1
Increase the property value of the area	291.4	7	274.3	2
Enhance aesthetic quality	304	4	272.9	4
Present wildlife habitat	211.2	11	206.8	11
Good for public health	277.2	9	266.9	5
Strengthen community spirit	307.1	3	253.2	7
Reduce air pollution	281.3	8	230.8	10
Purify air and environment	295.1	6	239.7	9
Cools the atmosphere	296.7	5	245.8	8
Allow more contact with nature	310.5	2	256.4	6
A place for relaxing or whiling away from home	247.8	10	273.3	3

Average scores =- 0=Not at all, 1=Slightly, 2= Somewhat, 3= Very, 4= Extremely Important

People of the Beach Park area also appreciated the outdoor activities as the top value of the conservation of the park which is similar to the Diyatha Uyana. As expected, this would reflect in the increase of property value which is a motivational factor for conserving and protecting such assets. Although people in Diyatha Uyana has placed the lowest score for the park as a place for relaxing or while away from home, people in Beach Park considers it as the third most important attribute for conservation. Finding wildlife in Beach Park is not possible; hence, people considered it the least important aspect of conservation.

4. Willingness to pay

The survey question 7 was targeted to measure household's WTP to support the development and conservation of urban water body program in both Diyatha Uyana and Beach Park. In this hypothetical scenario, people usually express their WTP for the subject to their income and other constraints in their family life. First, people were asked whether they are willing to pay a given amount of Rs.1000.00 monthly using a closed-ended WTP format in both locations. In Diyatha Uyana, roughly about 67 percent ($n=201$) of respondents showed their support for the program by saying "yes" as the answer. There was 33 percent of ($n=99$) zero bids for the WTP. Next, respondents were asked to indicate their perceived maximum amount of payment using open-ended WTP format. The mean WTP of households was Rs.446.93 monthly, which will amount to Rs. 5,363.16 per annum, suggesting that people are willing to pay a notable amount to develop and conserve open water bodies. Mean WTP in Beach Park was Rs. 211.53 per month which will amount to Rs. 2538.36 per annum. Multiple Linear Regression (MLR) model was used to estimate the factors affecting the respondent's WTP. The model R^2 value is very low (0.140), which usually vary between 0 and 1. R^2 is a statistical measure which describes how close the data are to the fitted regression line. It is also known as the coefficient of multiple determination in MLR. In some fields, it is entirely expected that R^2 values will be low. For example, any field that attempts to predict human behaviour, such as this study, typically has R^2 values lower than 50%. Human behaviour is simply harder to predict. The F value of the model is 3.775 which is good indicating the regression equation is good to explain the relationship between the WTP value and

the associated explanatory variables. As indicated in F test (or global test), the entire model for Diyatha Uyana is highly significant at $\alpha = 0.01$ (or 1%) level as the significant value of $0.003 < 0.01$. A F statistic is a value derive from running an ANOVA test or a regression analysis to find out if the means between two populations are significantly different. It's also similar to a t statistic from a t -test; A t test will tell if a single variable is statistically significant and an F test will tell if a group of variables are jointly significant.

ANOVA model is significant at 1% level as the significant value of F test is 1% level as significant value $0.003 < 0.01$. As indicated in coefficient table, some variables are significant and some are not, according to the t test. Among the other independent variables gender variable is significant at 1% ($0.001 < 0.01$) level and the job variable is significant at 10% ($0.067 < 0.10$) level. For every one-unit change in gender, the log odds of admission (versus non-admission) increases by 0.002. The expected sign for all independent variables chosen are positively contribute towards the WTP values except the age. Variables of age, income and being a member of an environmental group are however not significant.

ANOVA model and the estimated F value, 2.922 shows that the entire WTP equation is significant at 1% level as the sig value $0.004 < 0.01$. The global test shows the equation is good to explain the relationship between the WTP and explanatory variables. The coefficients estimated show the relationship between the WTP value and the individual explanatory variables.

Among the estimated β values education, have a child, time lived in the area variables are significant at 10% levels, as the sig values are smaller than 0.10 ($0.073 < 0.10$; $0.088 < 0.10$; $0.093 < 0.10$). Housing type is significant at 5% level as the relevant sig value, $0.049 < 0.05$. Unfortunately, all other variables used in the model are not significant. However, all the signs of the estimated significant model parameters are positive indicating that all variables are positively influencing the WTP values except the variable of time lived in the area. It is significant and negative implying that more time living the area influence for paying lower WTP value.

Motivation to pay or not to pay

Under question 9 it was aimed to understand the motivations behind the willingness to pay or not willingness to pay. It is important to know why exactly some people do but others do not willing to pay. First, participants were asked to mention *why would they pay that amount?* Findings indicate peoples' need for such places providing a green light for the policy makers and planners to build more open areas in urban settings. This reflects in almost half the sample in Beach Park and 45% of the sample in Diyatha Uyana ranked this program is important to them. People in Diyatha Uyana (44%) and 21% in Beach Park believe that it is their responsibility to protect open spaces. This reflects in their WTP amounts in both places. Some in both places believe that they want to contribute to a good cause. Participants were also asked the reasons behind their choice of zero willingness to pay for the water body development. Budget constraint was the major reason for the choice of not willing to pay in Diyatha Uyana while it was not that important in Beach Park. In overall sample, 27% of Diyatha Uyana and 7% of Beach Park were voted against the WTP.

5. Discussion

The survey results of both locations suggest people's strong desire for developing and conserving open water bodies in urban areas. This finding can be used to justify the planning decisions and also expenditure used upon developing urban water body recreational areas in cities. The importance and the occurrence of visiting open water bodies showed an overlapping ranking indicating people's high desire for having an attachment to the natural environment. The three top ranks for visiting open water bodies were related to acquiring environmental benefits in Diyatha Uyana and Beach Park. This may due to the reduction of open places in Sri Jayewardenepura municipal area and the Beach Park area of Matara with the rapid urbanization. With the busy lifestyle and the reduction of open spaces in a neighbourhood may have restricted the attachment to nature recently, however, the community and open water bodies have started to re-generate this behaviour. This behaviour pattern is somewhat related to the western people's motivations for visiting open green spaces. However, this is different from the findings from Hong-Kong. The changes of Sri Jayewardene Pura land use show the reduction of water bodies and marshy land. According to 2010 data of land use patterns show that this area consists 10.4% marshy land and 2.1% lakes which are very sensitive with eco-diversity. On the other

hand, the land area of Beach Park was secured by the location of the main Matara Hambantota road in one side and by the sea on the other side. The survey results in emphasis the need of developing and conserving open spaces in urban areas.

No parking places is a common issue faced by the users of both urban facilities. The increase of car ownership and peaceful environment after the civil war has accelerated people's mobility. The increase of public transportation would reduce the pressure on providing parking spaces. Lack of availability of open spaces seems to be an issue for the participants of the survey in both locations. There can be neighbourhood small potential places which have been neglected because of the more attractive urban recreational areas. Localizing some open recreational areas in neighbourhoods will reduce the pressure on city level places like Diyatha Uyana. Future urban recreational planning can use landscape ecological approach to maximize the spatial, social and environmental benefits (Jim & Chen, 2006). Overall, lack of infrastructure facilities was mentioned as obstacles in using Diyatha Uyana and surrounding recreational area. A requirement of more sporting facilities indicates people's increasing consciousness on health and wellbeing. This reflects the answers given to question one and two.

The findings of this study show the WTP for open water body recreational areas is high among the users and non-users of this study. It is significant for a developing country with people who have limited experience in applying a monetary valuation to eco-service systems. Currently, there is no entrance fee for open water body recreational areas in the country. Therefore, this research indicates that even people use these facilities for free for years, in-return they have a moral feeling to pay for the conservation of eco-service systems. The mean value of WTP in Diyatha Uyana is half of the amount usually people pay for an indoor physical exercise center in Sri Lanka. The value people pay in Beach Park was less than one-fourth of the charge of a physical exercise center. Budget constraint is also a key factor in determining the WTP. This phenomenon was also demonstrated in the results in two case studies. Diyatha Uyana average income was around Rs. 143080 which allows the sample respondents to pay a higher amount as WTP. The WTP amount was Rs.476.93 per month. The average income in Beach Park was Rs. 17223, consequently the WTP was Rs. 211.53. Budget constraint is one key factor in deciding the WTP. This study found that income and job had a significant positive influence on WTP for Diyatha Uyana. This is more compatible with some studies around the world regardless of the economic development of the country (Jim & Chen, 2006). This indicates that still Sri Lankan people consider recreational and amenity enjoyment as a superior good. However, education, have a child, housing type and time lived in the area showed a significant association with the WTP in Beach Park. The findings revealed that the moral and ethical considerations are not considered in valuing environmental amenities by the participants of both locations. This should be given more consideration when making policy decisions in future regarding enforcing fees for the use of natural resources. However, Tyrvaenen and Vaanane's (1998) study on the urban forest in Finland revealed that the income does not have any significant impact on people's WTP. Nonetheless, key factor of determining WTP is the budget constraint which makes us plan for a situation whereby income increases of poor people through employing them in natural resource areas. For the additional income, people live in the area could participate in activities geared towards environmental conservation. Eco-tourism is one such activity.

6. Conclusion

CVM studies are not very common in using for policy studies in Sri Lanka. The idea of applying a monetary value for the environmental good seems to be unusual for some participants which make some difficulty in fieldwork. As a new concept, it takes some time for the participant to understand the hypothetical situation. The describing hypothetical situation for participants to understand clearly is also a big challenge in carrying out a CVM survey. Some people might have thought of actual payment and could have given a lower amount regardless of their actual willingness (Wattage, & Mardle, 2008). Therefore, careful consideration should be given in drafting the survey and should give special emphasis to highlight the hypothetical situation in the survey. Training survey team is vital to getting reasonably good field data. Questionnaire design is also a challenge to capture real situation and creating a hypothetical situation to get real WTP value. Adopting a monetary value for eco-service systems could provide a justification for policy makers and planners. Development plans can be incorporated with public views and monetary value. By understanding people's motivation and incorporating those into planning decisions (Ratnayake & Butt, 2018) in return would attract more support in maintaining and conserving rather neglecting eco-service systems, thinking or criticizing

them as a government project. Finally, the current study provides a green light in conducting more CVM studies for valuing not only water body recreational developments in the country but also for the other environmental goods such as forests, biodiversity, eco-tourism and water resources. More and more economic valuations on urban open spaces would influence the policy and planning decision in the country. Therefore, it is important to conduct this kind of studies and then the people also would use to adopting an economic value for environmental goods.

7. References

- Brefle, W. S., Morey, E. R., & Lodder, T. S. 1998, Using contingent valuation to estimate a neighbourhood's willingness to pay to preserve undeveloped urban land. *Urban Studies*, 35(4), 715-727.
- Butt, A., Ratnayake, R., & Budge, T. (2016). Planning education and inter-cultural collaboration: awareness, innovation, reflection and preparation for practice. *Bhumi, The Planning Research Journal*, 3(1).
- Chieura, A. (2004). The role of urban parks for the sustainable city. *Landscape and Urban Planning*, 68(1), 129-138.
- De Silva, C. S., Warusavitharana, E. J., & Ratnayake, R. (2017). An examination of the temporal effects of environmental cues on pedestrians' feelings of safety. *Computers, Environment and Urban Systems*, 64, 266-274.
- Hanemann, W. M. 1994, Valuing the environment through contingent valuation. *The Journal of Economic Perspectives*, 8(4), 19-43.
- Rahim, K. A. 2008, *Contingent Valuation Method*. Paper presented at the Regional Training Workshop: Economic Valuation of the Goods and Services of Coastal Habitats, Thailand
- Ratnayake, R. (2017). Sense of safety in public spaces: university student safety experiences in an Australian regional city. *Rural Society*, 26(1), 69-84.
- Ratnayake, R. (2013). Environmental features and sense of safety. *WIT Transactions on Ecology and the Environment*, 179, 377-388.
- Ratnayake, R., & Butt, A. (2018). Encounters with the unfamiliar: international planning education. *International Planning Studies*, 23(1), 51-64.
- Salazar, S. d. S., & Menendez, L. G. 2007, Estimating the non-market benefits of an urban park: Does proximity matter? *Land Use Policy*, 24, 296-305.
- Shang, Z., Che, Y., Yang, K., & Jiang, Y. 2012, Assessing Local Communities' Willingness to Pay for River Network Protection: A Contingent Valuation Study of Shanghai, China. *International Journal of Environmental Research and Public Health*, 9, 3867-3887.
- Wattage, P. and Mardle, S. (2008) Total economic value of wetland conservation in Sri Lanka identifying use and non-use values, *Journal of Wetland Ecology and Management*, Volume 16, Pages 359-369.
- Wickramaarachchi, N., Ratnayake, R., & Wattage, P. (2017). Willingness to pay for open water body recreational facilities: A case study at Diyatha Uyana. Paper presented at FARU international research conference, University of Moratuwa, Sri Lanka. 8-9 December 201

Samarawickrama, Sumanthri, et al (eds), 2018, "Sustainability for people - envisaging multi disciplinary solution": Proceedings of the 11th International Conference of Faculty of Architecture Research Unit (FARU), University of Moratuwa, Sri Lanka, December 08, 2018 Galle pp. 341–345. ©

FORM DEVELOPMENT OF CLAY MODULE FOR OPTIMIZE EVAPORATIVE COOLING WITH WIND FLOW

LIYANARATHNE. B.L.S.W¹, RANASINGHE. W.M.N.D² & HALWATURA R.U³

^{1,2}Department of Integrated Design, University of Moratuwa, Sri lanka

³Department of Civil Engineering, University of Moratuwa, Sri lanka

¹sandeepani.wasana@gmail.com, ²dilshaniranasinghe80@gmail.com, ³Rangikauh@gmail.com

Abstract

Evaporative cooling is one of most important passive cooling systems which is used since ancient times. As a passive cooling system direct evaporative cooling is the basic method. There are most of evidences in use of wetted clay material in evaporative cooling method. Mashrabya and wetted clay conduits used in wind towers are the proofs on this passive cooling system. Clay exhibit excellent properties on evaporative cooling as a porous material. Porous ceramics exhibit properties such as high permeability, low bulk density, high surface area, and low thermal conductivity. There are more possibilities on enhancing the evaporative cooling. The research focused on the form development which multiplying the cooling efficiency. Provide a large surface area to air touching, access to easy air flowing and making a speed for air flow are the archived aims which are multiplying the cooling effect in the research. Various forms have tested in the research with the smoke flows as air flow and identified best form. And the form has developed with the literature which is about clay form development. Close ended form of clay has identified as more efficient on the evaporative cooling. This basic form has a possibility to develop as a sustainable product design for people. The formed product changes the situation of Natural wind or created wind flow as a chilled air by the evaporative cooling in zero energy. In a warming world, heating energy demands should reduce while cooling energy demands rise. Further investigations of the form development respond for this circumstance as a design solution.

Keywords: Form Development, Air stream, evaporative cooling, passive technique

1. Introduction

In a warming world, heating energy demands should reduce while cooling energy demands rise. (Mishra, Loomans, & Hensen, 2016). Cooling demand of the world has increased on the circumstance of global warming. Evaporative cooling is one of prevalent method in the world as a passive cooling technique. Evaporative cooling is a heat and mass transfer process that uses water evaporation for air cooling, in which large amount of heat is transferred from air to water, and consequently the air temperature decreases. (O Amer, Boukhanouf, & Ibrahim, 2015)

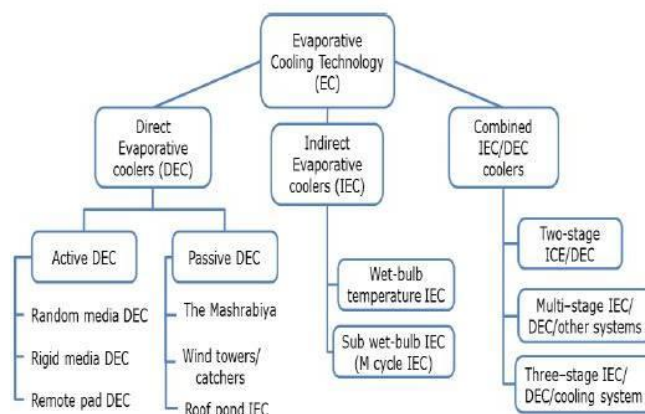

Figure 1, classification of evaporative cooling (Source; Ouf, R.Ibrahim, H. G.Amer, O.Boukhan,2015)

In hot climates, ancient Greeks and Babylonians were used wet mats overhanging doors and windows and water filled clay jars on balconies to capture a cool breeze into the living spaces. (Omar Amer, 2017) They used simple methods to cool their inner environment depend on the evaporative cooling basics. Mashrabya is a traditional Islamic architectural element which is used as a cooling technique. It is wooden screens/windows provides shad, protection from the sun and allows breezes to flow through into the building for cooling purpose. Mashrabiya system coupled with porous water-jugs to provide evaporative cooling effect for a dwelling and cooling water inside jugs for water drinking. (O Amer et al., 2015)

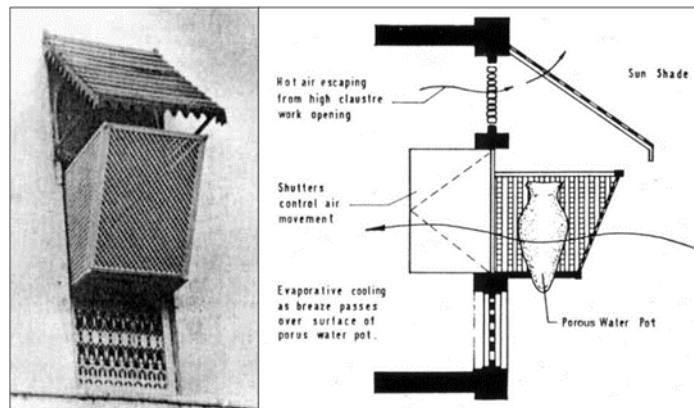

Figure 2, Mashrabya (Source; Ouf, R.Ibrahim, H. G.Amer, O.Boukhan,2015)

Wind tower is a example in usage of direct evaporative cooling technique. Wind towers with wetted columns consist of unglazed ceramic conduits stacked lengthwise on top of one another or thick dampers. Water is uniformly sprayed on the surface of the column, dampening the entire column. (Dehghani-Sanij, Soltani, & Raahemifar, 2015) And also air spraying systems and water filled clay jars have used in wind catchers to cool the air-stream

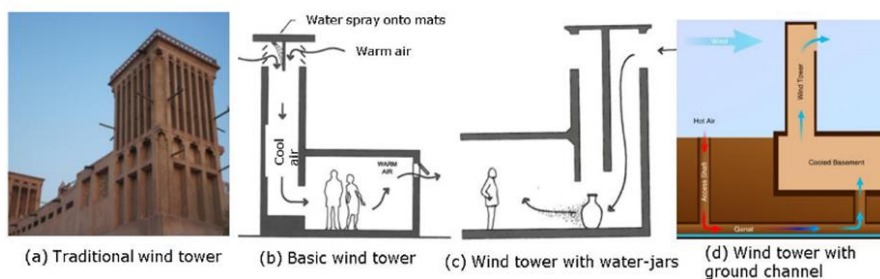

Figure 3, Wind tower (Source; O Amer et al., 2015)

These passive direct evaporative cooling systems were mostly used in regions which was in cooling demand. Properties of the clay material has maintained the capacity of evaporative cooling. In general, porous ceramics exhibit excellent mechanical properties, chemical and abrasion resistance, and thermal stability. Cooling is a function of porosity, configuration, and water supply pressure. A high surface area is preferred because the evaporative surface area is crucial to the evaporation rate. (Emdadi et al., 2016) Most of the ancient direct evaporative cooling applications emerge with the clay material property. Ancient designers mainly focused on the material quality but not on-air flowing space.

The research investigates the space which is covering by the air stream causes to evaporative cooling. Path of airstream defined by the research to enhance the cooling effect exclusive of clay material quality.

2. Methodology

The research mainly focused on the problem which is facing contemporary world. The literature review identifying the circumstance of global warming and Historic simple passive techniques used against the problem. Material quality and the usability of evaporative cooling technique investigates. Specific

requirements and elements of the passive direct evaporative cooling has identified by these preliminary studies and literature review. The study conducted on the space usage of airstream in the evaporative cooling application. In the form development stage various shapes has tested by the air streams. And finalize a better form according to the experiments and air stream observations to develop a new design on clay material for passive direct evaporative cooling.

3. Form Development.

3.1. PRELIMINARY STUDIES

Main Historic Applications of “Passive direct evaporative cooling” has used as preliminary studies in the research. Mashrabya and wind towers are the main passive direct evaporative cooling techniques according to O. Amer, R. Boukhanouf, and H. G. Ibrahim. These couple of building elements highly considered on the airstream. Air movement (velocity) influences the performance of an evaporative cooling system. Consequently, configurations that stimulate high air mass flow (velocity) and have large surface areas for seepage flows to navigate have high cooling rates. (Emdadi et al., 2016). The preliminary studies are deeply investigating the air movement on these elements and how the surface area influenced to cool the air stream.

3.1.1 Mashrabya

Mashrabya is a passive direct evaporative cooling technique which is used in ancient Islamic regions. It is some kind of natural ventilating system. They build a separate partition to arrive air stream to indoor with clay water jar. The air stream makes a contact with the outer surface of water jar when reach to inner enclosed space. It makes airstream cool through evaporative cooling technique. That is the basic theory of the mashrabya building integrated system.

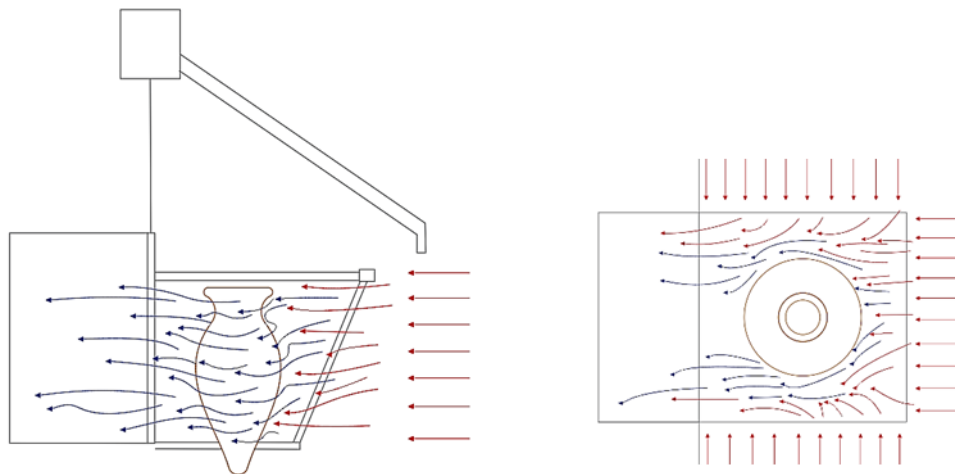

Figure 4, Airstream operation of Mashrabya (side view, top view)

The form of clay jar makes 360° contact with air stream. Although fully surface area opened to the air stream, only the nearest air stream makes coolness depend on the form. Open spherical form diverging path to the air stream. The form maintains the speed of air stream with spherical form. Divergent way which maintain the open spherical form is one of negative quality identified in the case study. It dissipates the air velocity without cooling.

3.1.2 Wind tower

The wind tower, also called wind catcher is a traditional Passive cooling technique of buildings, existed hundreds of years ago in the Middle East and Iran, known as “Burj al hawaa” the air tower. A capped tower with one face opening or multi-face openings at the top of tower, the tower is placed on the roof of a dwelling. Wind towers/catchers could be divided according airflow patterns inside the tower into: downward airflow towers and upward airflow towers. (O. Amer, Boukhanouf, & Ibrahim, 2015). Wind towers are the building elements to make an airstream path to inner enclosed space. Some of them are modified with evaporative cooling technique to make the wind cool.

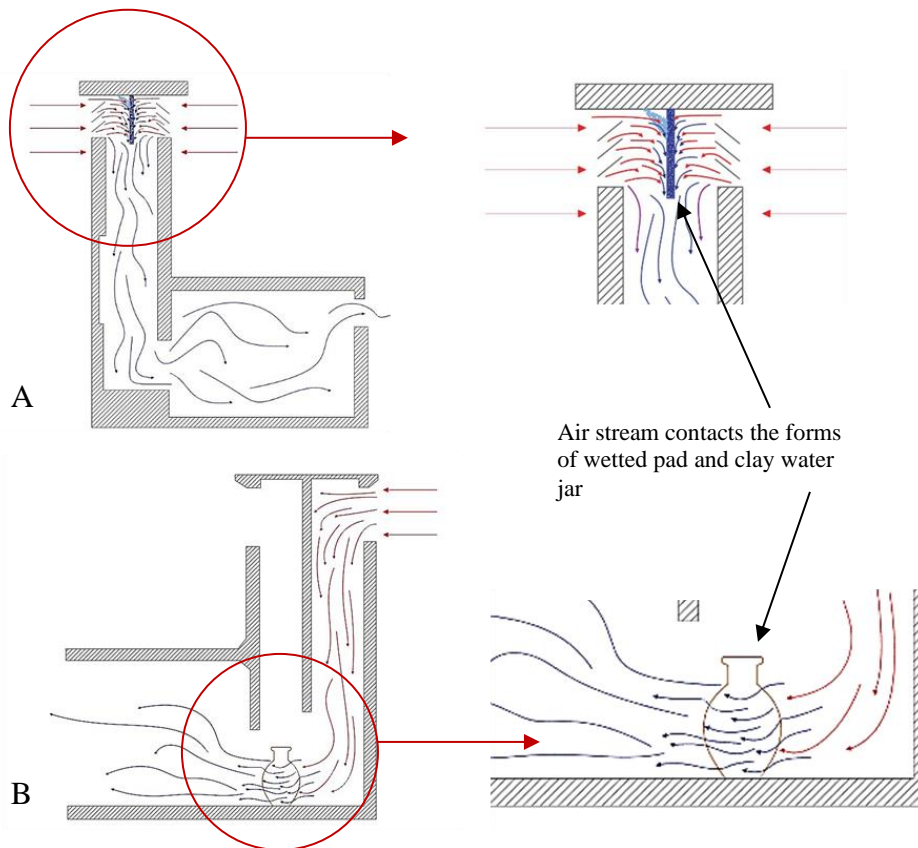

Figure 5, Airstream operation of wind

First wind catcher makes air stream cool with wet pads. Air stream straightly impact with wet pads and it makes the path to air stream. It decreases the probability of airstream which enter the tower without cool. Rigid form opposes the speed of air stream. Second one works same as the Mashrabya.

3.2. FORM EXPERIMENTS- AIR FLOWING IN SPACE

According to the research findings air stream is on of most considerable facts in passive direct evaporative cooling technique. The air flowing pattern influence the cooling effect coupling with material quality. Touching large surface area and maintain the speed of airstream are the main requirements of form development. Studied couple of cases consist with basic two forms as open spherical and straight to make a path for airstream.

The research is based on the different types of form analysis based on Straight, curve forms. (A,B,C,D,E) These experiments to identify the best formation to fulfill the requirements of provide large surface are and maintain air velocity.

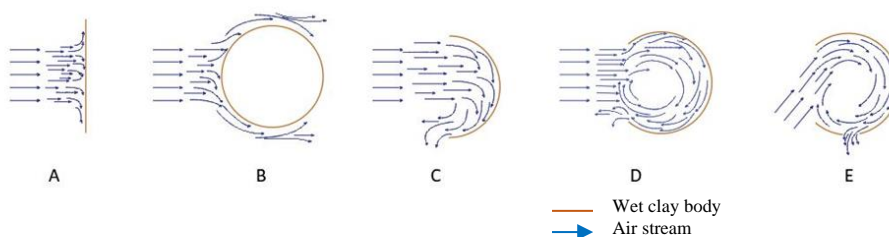

Figure 6, Airstream experiments on various forms

A is a straight wet module. It contacts airstream properly. But the form opposes the speed of air stream as an obstruction. It same as the first type of wind towers evaporative cooling element.

B is a form which works same as Mashrabya and second type of wind towers cooling pot. It also makes a good contact with the airstream and create an air path divergently. Air speed is maintaining by the spherical form.

C form make half rotation for the air stream with maintaining the air speed. There is a possibility to develop the form with continuing convergent rotation.

D is a close ended form which continuing the air stream in convergent path. Continuous rotation makes high surface area to touch the air stream. And it maintains the air speed as well.

E is a development stage of the form D. The efficiency of the form has tested by the incline the arriving air stream. It repeats the rotation in the form by contacting more surface area.

4. Results and Discussions

According to the investigation air stream mostly influenced to the enhance efficiency of evaporative cooling. Provide high surface area and maintain the speed of airstream are the main requirements for airstream in efficient evaporative cooling. The research identifies a basic form after the experiments on various forms. Close ended spherical form fulfills both requirements according to the experiments. Efficiency of the form has enhanced with changing the path of arriving airstream.

The basic form which makes a path to airstream in evaporative cooling technique has revealed by the study. It adduces the possibility of develop an efficient passive cooling system for sustainable world. Form based product design can develop for the any kind of ventilator as a passive cooling unit.

4. Conclusion

Air stream is a highly considerable fact in the passive direct evaporative cooling systems. Main ancient examples of Mashrabya and wind towers are highly considered on the wetted media of evaporative cooling system. The study identifies the operation of airstream on these basic forms and the defects of action in air stream for efficient evaporative cooling. Clay body is a better media in evaporative cooling technique. Finally, the research identifies a competent form to make a path for airstream of direct evaporative cooling system. Close ended spherical form with angular entering of air stream is the best basic method according to the experiments. Efficiency of the evaporative cooling is effect by the air stream integrated with mechanical and chemical properties of the clay body. The basic form convinces the possibility of developing a form based passive direct evaporative cooling system. There is a requirement in sustainable solutions in all the problems in the world. Global warming is one of considerable problem in near future. The research makes a path for product design sector to develop a zero-energy clay module to optimize cooling as a solution for highest cooling demand.

5. References

- Amer, O. (2017). A heat pipe and porous ceramic based sub wet-bulb temperature evaporative cooler: a theoretical and experimental study. Retrieved from <http://eprints.nottingham.ac.uk/43343/>
- Amer, O., Boukhanouf, R., & Ibrahim, H. (2015). A Review of Evaporative Cooling Technologies, (November 2014). <https://doi.org/10.7763/IJESD.2015.V6.571>
- Amer, O., Boukhanouf, R., & Ibrahim, H. G. (2015). A Review of Evaporative Cooling Technologies. *International Journal of Environmental Science and Development*, 6(2), 111–117. <https://doi.org/10.7763/IJESD.2015.V6.571>
- Dehghani-Sanij, A. R., Soltani, M., & Raahemifar, K. (2015). A new design of wind tower for passive ventilation in buildings to reduce energy consumption in windy regions. *Renewable and Sustainable Energy Reviews*, 42, 182–195. <https://doi.org/10.1016/j.rser.2014.10.018>
- Emdadi, Z., Asim, N., Yarmo, M. A., Shamsudin, R., Mohammad, M., & Sopian, K. (2016). Green material prospects for passive evaporative cooling systems: Geopolymers. *Energies*, 9(8). <https://doi.org/10.3390/en9080586>
- Mishra, A. K., Loomans, M. G. L. C., & Hensen, J. L. M. (2016). Thermal comfort of heterogeneous and dynamic indoor conditions d An overview, 109, 82–100. <https://doi.org/10.1016/j.buildenv.2016.09.016>

Samarawickrama, Sumanthri, et al (eds), 2018, "Sustainability for people - envisaging multi disciplinary solution": *Proceedings of the 11th International Conference of Faculty of Architecture Research Unit (FARU), University of Moratuwa, Sri Lanka, December 08, 2018 Galle* pp. 346–353. ©

EXPERIMENTAL INVESTIGATION ON THE OPTIMAL LIFTING HEIGHT OF A SELF-COMPACTING IN-SITU CAST MUD-CONCRETE LOAD-BEARING WALL SEGMENT

F.R. AROOZ¹, K.L.T.H. PERERA², MADUJITH SAGARA CHANDRA³ & R.U. HALWATURA⁴

Department of Civil Engineering, Faculty of Engineering, University of Moratuwa, Sri Lanka

¹rizznaz@gmail.com, ²tharinduharshika@gmail.com, ³madujithsagara123@gmail.com, ⁴rangikauh@gmail.com

Abstract

Initial objective of this research is investigating the optimum lifting height of a wall segment of self-compacting in-situ cast Mud-Concrete load bearing walls. It is a novel walling technique which has been developed through series of research process in Sri Lanka. Thus, identifying the possible construction height of a Mud- Concrete wall without reducing the strength is very important when introducing a novel material to industry and popularizing the technique among public. A questionnaire survey was conducted among 400 construction workers to identify the comfortable pouring height of an in-situ cast wall segment prior to design the formwork and it was found as 1200mm height. Using the results, 1200mm x 1200mm (height x width) and 150 mm thick of Mud-Concrete wall was casted and drilled after 28 days to test the compressive strength of cored samples along four different heights of the wall. According to the results obtained, increasing the height of the Mud-Concrete wall does not reduce the compressive strength of the wall. Therefore, study concludes that, there is no height restriction in construction of a Mud-Concrete wall. However, 1200mm of comfortable lifting height is consider as the optimum lifting height of a wall segment and used the results in modular formwork fabrication.

Keywords: *Optimum lifting height, In-situ cast load bearing walls, Mud-Concrete, Self-compaction, Compressive Strength, Cored samples*

1. Introduction

The earthen building technologies have been used worldwide for thousands years because of the simple construction technologies, local environmental friendly material usage (Ma et al., 2016), (Van Damme and Houben, 2017), (Fay et al., 2001), economic affordability (Omar Sore et al., 2018), (Arrigoni et al., 2017), thermal comfortability (Allinson and Hall, 2010), (Allinson and Hall, 2012), (Hall and Allinson, 2009) and low embodied energy consumption (Morel et al., 2001), (Christoforou et al., 2016), (Galán-Marín et al., 2015). Most importantly use of local materials and in-situ constructions are resulting to eliminate the transportation cost and associated CO₂ emissions in earthen technologies. Though earthen architecture is popular due to its sustainable norms and using as building material in low cost residential development projects the popularity is limited due to the lack of scientific base in earthen construction comparing to the other prevailing construction technologies which are exist (Bernat Masó et al., 2016). Thus proper scientific base and corresponding standards must develop to popularize the earthen technologies to use confidently and compete with other contemporary construction materials.

Mud-Concrete (MC) is such a novel and sustainable construction technology which introduced through series of research process recently (Arooz et al., 2017b), (Halwatura, 2016). The concept of MC is to develop a composite material similar to concrete out of soil (Arooz and Halwatura, 2017). There are two types of masonry units could develop through MC technology. First one is Mud-Concrete Block (MCB) (Halwatura, 2016), (Arooz and Halwatura, 2017) and the second one is in-situ cast Mud-Concrete load bearing wall (MCW) (Arooz and Halwatura, 2016), (Arooz et al., 2017a), (Bandara et al., 2016). In this research our focus is to discuss about the self-compacting in-situ cast Mud-Concrete load-bearing walls (MCW). MC is self-compacting material which develop with 20% optimum water of the total dry mix (Arooz and Halwatura, 2017). The best mix design of MCW was found as 45% gravel (4.75mm <gravel < 31.5mm), 50% sand (0.425mm <sand <4.75mm) and 5% fine (fine < 0.425mm) with minimum 4% cement (Arooz et al., 2017a). After identifying the mix design, it is important to identify the optimum construction technology for newly developed material. Thus, identifying the

optimum construction height of a wall segment is most important to enhance the workmanship and standardize the construction technology.

The optimum construction height of an in-situ cast wall can be affected by different factors such as segregation of material when increasing the wall height, the workmanship available at the site, the techniques use for handling and fixing formwork/mould of the wall, etc. Whilst introducing a new in-situ cast load-bearing walling material, it is important to check the strength variation with the height of the wall. Similarly, this optimum construction height of the wall will govern the speed of the construction process. As recorded in literature, the testing of optimum lifting height of Stabilized Rammed Earth (SRE) wall was done in two (02) methods (Lombillo et al., 2014),(Ciancio and Gibbings, 2012). First one is moulding sample from the same mixture of casted wall and testing the compressive strength variations of the block or cylinder moulds. Second one is core the casted wall and get the cored sample to check the compressive strength variations. Recorded results depict that moulded samples are almost two times stronger than the cored samples of SRE. Horizontally cored samples are slightly stronger than the vertically cored samples of SRE. Ciancio and Gibbings assume this difference may be occurred due to the intersection of coring samples with ramming lines (Ciancio and Gibbings, 2012). However, the main objectives in this research is to investigate comfortable, optimum lifting height of MCW. Thus, the two main methods (qualitative and quantitative) were adopted to achieve the said objectives in the study.

2. Materials and methods

2.1. METHOD 01: QUESTIONNAIRE SURVEY

A questionnaire survey has been conducted among the 400 sampling of construction workers (especially concrete workers in different sites) to identify mainly the comfortable lifting height of pouring concrete to a wall or a column. Simultaneously, the questionnaire was focused to identify the issues in placing the concrete to a wall or a column and the practical issues occurred in assembling and disassembling the formwork systems.

2.2. METHOD 02: CORE SAMPLE TESTING

a. Finding the existing particle size distribution of used sub-soil samples

Gravelly laterite soil was used to commence the investigations. Soil samples were obtained from a homogeneous layer; 600mm-900mm below the top of the soil to get the good composition of soil and to avoid the organic particles in the soil samples. Three (03) random air-dried soil samples were used to conduct the sieve analysis tests to understand the existing particle size distribution of the soil while minimizing the errors. Liquid limit, plastic limit and plastic index were obtained by conducting Atterberg limit tests (Table 1). The average values of gravel 40.85%, sand 47.49% and fine 1.66% was available in existing soil samples (Figure 1). Then the soil was developed up to the achieved best mix design of MCW.

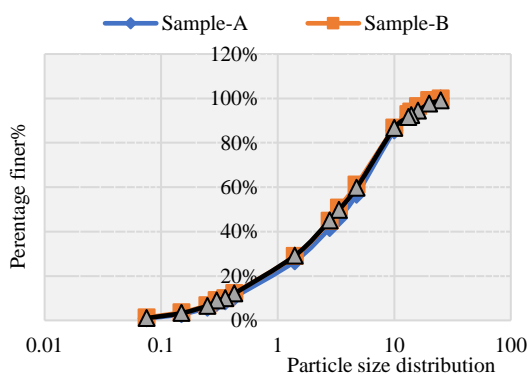

Figure 41, Particle size distribution of

b. Developing the soil and casting the wall specimen

Table 1, Physical properties of selected virgin soil

Properties	Values
Liquid limit	35.99%
Plastic limit	21.78%
Plasticity index	14.95%
Dry density (soil gravel)	1600 -1800 kg/m ³
Wet density (soil gravel)	1800 - 2100 kg/m ³

The sieve analysis results were used to develop the virgin soil up to the achieved best mix by adding needed gravel and sand while keeping the 5% fine content in the total mix. Four (4%) percent minimum cement quantity was used in geo-polymerization of MCW. Wall specimens were cast in optimum segment size (obtained results of the questionnaire survey were used) of 1200mm height, 1200mm width and 150mm thickness for the purpose of core testing. Table 2 shows the needed total soil quantity and the added gravel and sand to cast a single wall segment.

Table 2, Needed soil quantities for one wall segment and developing the soil according to the best mix of Mud-Concrete wall

Total weight of the mix to cast a one wall segment – size 150mm(thick), 1200mm(width), 1200mm(height) (To keep 5% fine from the total weight of the mix)							641.3 kg
Added cement (4% of the total weight of the mix)							25.65 kg
Sample No: (ex.)	Sample weight of the soil (kg)	Existing proportions and weight			Proposed proportions and weight		
		Gravel	Sand	Fine	Gravel	Sand	Fine
W1	275	40.85%	47.49%	11.66%	45%	50%	5%
		112.34kg	130.59kg		288.58kg	320.65kg	32.07kg
Added gravel to keep the 5% fine in the mix (kg)							176.25 kg
Added sand to keep the 5% fine in the mix (kg)							190.05 kg

Formwork was removed after 24 hours and curing procedure was started soon after formwork dismantling. Wall specimen was cured for 14 days using wet gunny bags at room temperature (± 25 °C Temperature, $\pm 75\%$ Relative humidity).

c. Core cutting and compressive strength testing of cored samples

Wall specimen was cored using a core cutter machine to check the compressive strength of cored samples after 28 days (Figure 2 and Figure 3). The diameter of core specimen should be at least 94mm to determine the compressive strength in load bearing structural members (ASTM, 2004). Because the preferred minimum core diameter is three (03) times the nominal maximum size of the coarse aggregate (ASTM, 2004). The core locations were marked on the wall in different heights prior to take the samples (Figure 2). The blade of the core cutter machine kept perpendicular to the wall surface while obtaining cored samples from the MC wall in different heights (Figure 3). The faces of some samples were damaged due to the practical issues occurred while drilling the MC wall (Figure 4). Therefore, a capping had to be applied on each faces of the cored samples to make the faces even and flat (Figure 6).

Obtained core samples were stored in separate plastic bags (seal to prevent moisture loss) and kept at ambient temperature and protected from without exposing to direct sunlight. A 5mm thick capping was applied to maintain flat surface from both ends (ASTM, 2004). Cores were crushed using an electronic load testing machine (Figure 5). Calculate the compressive strength of each specimen using the computed cross-sectional area based on the average diameter of the specimen. Then compressive strength of the cored samples extracted in different heights along the MCW was plotted to see the compressive strength variation. The preferred length of the capped or ground specimen should between 1.9 and 2.1 times the diameter. If the ratio of the length to the diameter (L/D) of the core exceeds 2.1, reduce the length of the core so that the ratio of the capped or ground specimen is between 1.9 and 2.1. Core specimens with length-diameter ratios equal to or less than 1.75 require corrections to the measured compressive strength (Table 3). A strength correction factor is not required for L/D greater than 1.75. A core having a maximum length of less than 95 % of its diameter before capping or a length less than its diameter after capping or end grinding shall not be tested (ASTM, 2004).

Table 3, Correction factors for L/D Values

Ratio of Length to Diameter (L/D)	Strength correction factor
1.75	0.98
1.50	0.96
1.25	0.93
1.00	0.87

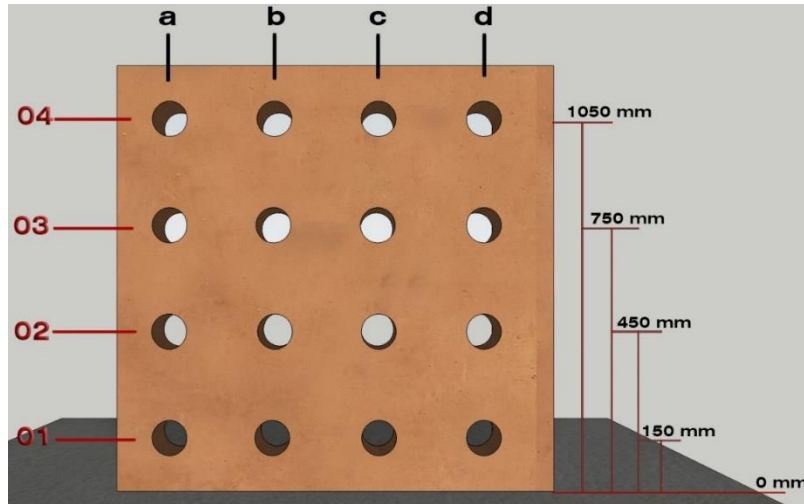

Figure 42, Cored locations along the MC wall



Figure 4, MC core samples



Figure 3, Obtaining MC core samples



Figure 5, Applied capping on both side of MC sample



Figure 6, Checking the compressive strength of MC sample

d. Compressive strength testing of moulded samples

Same MC mix (which is used to cast the MC wall) was used to cast the 150mm x 150mm x 150mm MC blocks to check the dry compressive strength of moulded samples. Six (06) similar samples were cast and cured for 14 days using wet gunny bags at room temperature ($\pm 25\text{ }^{\circ}\text{C}$ Temperature, $\pm 75\%$ Relative humidity). Dry compressive strength of the blocks were tested after strength gain in 28 days.

3. Results and discussion

3.1. QUESTIONNAIRE SURVEY

According to the results analyzed of survey conducted among construction workers at different construction sites (Figure 7), it was found that 90% of workers are comfortable with 1200mm (4'-0") of concrete pouring height to a wall or a column (Figure 8). Further, 5% of the workers are comfortable with 1500mm (5'-0") pouring height and the rest of 5% of the workers are comfortable with 900mm (3'-0") pouring height. Thus, it was understood the correct physical ergonomics are more important to optimize the construction methodologies and introduce labour free methodologies effectively.

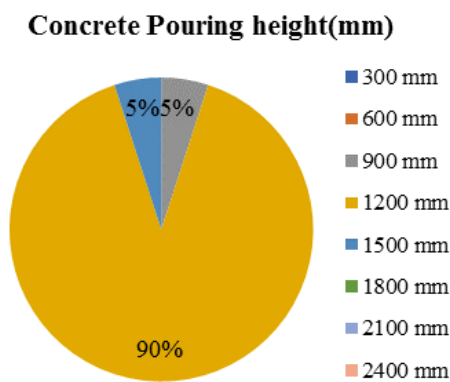

Figure 7, Worker's preferences on concrete pouring height

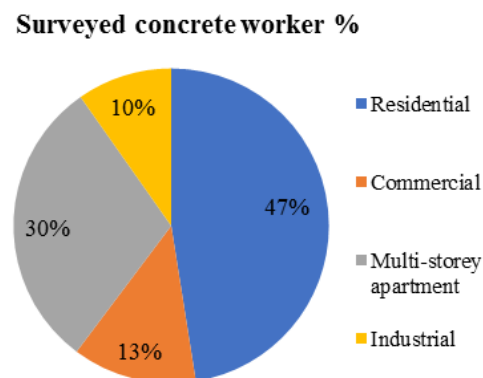

Figure 8, Survey carried on different construction sites and surveyed percentage of workers

Though, the comfortable height was found as 1200mm (4'-0"), it was doubtful whether the needed strength could achieve within this 1200mm height in MCW segment. Therefore, it was urging to fill this gap between the comfortableness & the structural capability in practical aspects. Maximum construction height of a wall segment should not reduce the strength of the wall in total construction process. Hence the core testing was conducted to check the behaviour of compressive strength of core samples extracted along MC wall to identify the most optimum lifting height of a MCW segment.

3.2. CORE SAMPLE TESTING

Table 4, Obtained compressive strength values for cored samples taken from different heights through Mud-Concrete load bearing wall

Core Number	wall height(mm)	Compressive strength(N/mm ²)
01/a	150	1.38
01/b	150	1.50
01/c	150	-
01/d	150	1.45
02/a	450	1.38
02/b	450	-
02/c	450	1.59
02/d	450	1.44
03/a	750	1.45
03/b	750	1.53
03/c	750	1.40

03/d	750	-
04/a	1050	1.35
04/b	1050	1.55
04/c	1050	1.36
04/d	1050	1.50

Results show that increasing the height of the wall does not reduce the compressive strength of the MCW (Figure 9 and Table 4). Therefore, there is no height restriction for constructing a MC wall segment. Thus, the required total wall height can cast once, since there is no height restriction in achieving the strength of the wall. But considering the comfort of the workers, the size of optimum size of a MC wall segment was finalised as 1200mm (4'-0") in construction. Correspondingly this data was forwarded to use the formwork fabrication and optimisation in the next level of the research.

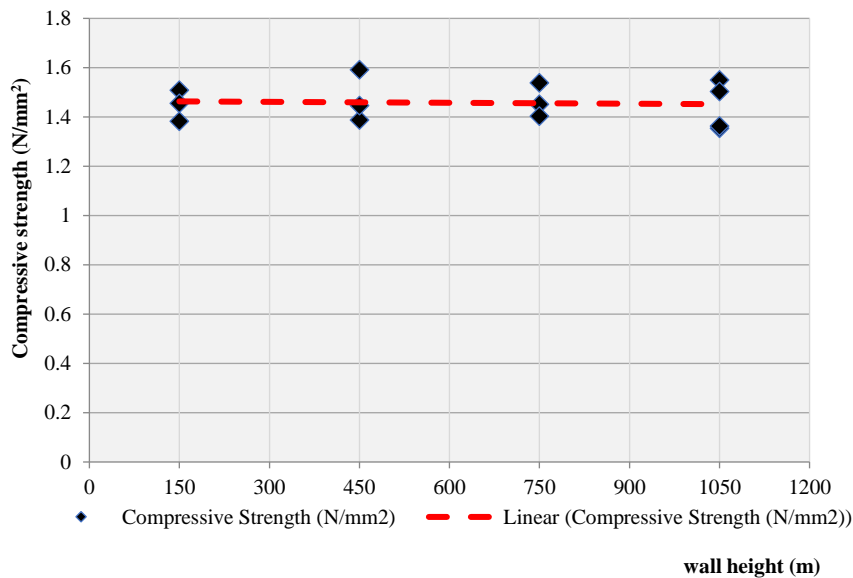

Figure 9, Behavior of the compressive strength variation along the height of the Mud-Concrete load bearing wall

3.2. MOULDED SAMPLE TESTING

Table 5, Average dry compressive strength values of moulded samples and comparison of average values of cored samples

Dry Compressive Strength (N/mm ²) of MC with 4% cement							
S:01	S:02	S:03	S:04	S:05	S:06	Average Values of moulded samples	Average values of cored samples
3.05	3.10	3.02	3.0	3.15	3.03	3.05	1.45

Table 5 shows the average compressive strength values of MC moulded samples. The values depict that compressive strength of moulded samples are always greater than the compressive strength of cored samples. Further the results confirmed that MC moulded samples are stronger than MC cored samples more than two times. MC cored samples are giving less compressive strength, because bonding between the gravel particles are getting weaker due to cutting and vibration in coring process.

4. Conclusion

Identifying the optimum height of a MCW segment is important to reduce the repercussion in construction. Because this optimum construction height of the wall will govern the speed of the construction of the wall and quality of the overall work presented at the end. The optimum construction height of a wall can be affected by different factors such as segregation of material by increasing the wall height, the workmanship available at the site, the techniques use for handling and fixing formwork/mould of the wall and etc.

The experiment results confirmed that moulded MC samples are stronger than the cored MC samples. Further, the results demonstrated that increasing the height of the MCW does not reduce the compressive strength of the wall. Therefore, there is no height restriction for constructing an in-situ cast MC wall segment. But then again the comfortable height of pouring concrete to formwork was found as 1200mm (approx.4'-0") through the questionnaire survey conducted among 400 construction workers in different construction sites. Therefore, the formwork to cast a one wall segment was optimized up to 1200mm height. Since there is no height restriction, the total wall height (1200mm – height of a one wall segment) can be casted at once without proposing any joints.

5. References

- Allinson, D., Hall, M., 2012. Humidity buffering using stabilised rammed earth materials. *Proc. Inst. Civ. Eng. - Constr. Mater.* 165, 335–344. <https://doi.org/10.1680/coma.11.00023>
- Allinson, D., Hall, M., 2010. Hygrothermal analysis of a stabilised rammed earth test building in the UK. *Energy Build.* 42, 845–852. <https://doi.org/10.1016/j.enbuild.2009.12.005>
- Arooz, F.R., Babilegedara, T.D., Halwatura, R.U., 2017a. Effect of Aggregate Percentage on Compressive Strength of Self-Compacting In-Situ Cast Mud - Concrete Load Bearing Walls, in: CFP17B72-PRT. Presented at the 3rd International MERCon 2017, IEEE, University of Moratuwa, Sri Lanka, p. 48.
- Arooz, F.R., Halwatura, R.U., 2017. Mud-Concrete Block (MCB): Mix design & Durability characteristics. *Case Stud. Constr. Mater.*
- Arooz, F.R., Halwatura, R.U., 2016. Self-Compacting in-situ cast Mud-Concrete load bearing wall system. 18762.
- Arooz, F.R., Udawatha, C., Halwatura, R.U., 2017b. Community empowerment through Mud-Concrete technology Sustainable building techniques to revitalise the war victim communities in Batticaloa, Sri Lanka, in: World Sustainable Built Environment Conference 2017, Hong Kong. Presented at the World Sustainable Built Environment Conference 2017, Hong Kong, Construction Industry Council and Hong Kong Green Building Council Limited, Hong Kong.
- Arrigoni, A., Beckett, C., Ciancio, D., Dotelli, G., 2017. Life cycle analysis of environmental impact vs. durability of stabilised rammed earth. *Constr. Build. Mater.* 142, 128–136. <https://doi.org/10.1016/j.conbuildmat.2017.03.066>
- ASTM, I., 2004. ASTM C42/C42M-04-Standard Test Method for Obtaining and Testing Drilled Cores and Sawed Beams of Concrete1.
- Bandara, D.M.H., Arooz, F.R., Halwatura, R.U., 2016. Effect of Gravel size on strength of Mud-Concrete, in: Civil Engineering Research Symposium-2016. Presented at the CERS-2016, Faculty of Engineering, University of Mortuwa, pp. 62–65.
- Bernat Masó, E., Gil Espert, L., Escrig Pérez, C., 2016. Textile-reinforced rammed earth : experimental characterisation of flexural strength and toughness. *Constr. Build. Mater.* 106, 470–479. <https://doi.org/10.1016/j.conbuildmat.2015.12.139>
- Christoforou, E., Kylili, A., Fokaides, P.A., Ioannou, I., 2016. Cradle to site Life Cycle Assessment (LCA) of adobe bricks. *J. Clean. Prod.* 112, 443–452. <https://doi.org/10.1016/j.jclepro.2015.09.016>
- Ciancio, D., Gibbins, J., 2012. Experimental Investigation on the Compressive Strength of Cored and Molded Cement-Stabilized Rammed Earth Samples. *Constr. Build. Mater.*
- Fay, R., Owen, C., Treloar, G.J., 2001. Environmental assessment of rammed earth construction systems. *Struct. Surv.* 19, 99–106. <https://doi.org/10.1108/02630800110393680>
- Galán-Marín, C., Rivera-Gómez, C., García-Martínez, A., 2015. Embodied energy of conventional load-bearing walls versus natural stabilized earth blocks. *Energy Build.* 97, 146–154. <https://doi.org/10.1016/j.enbuild.2015.03.054>
- Hall, M., Allinson, D., 2009. Analysis of the hygrothermal functional properties of stabilised rammed earth materials. *Build. Environ.* 44, 1935–1942. <https://doi.org/10.1016/j.buildenv.2009.01.007>
- Halwatura, R.U., 2016. Mud Concrete Block. 17616, EO4C 1/100, B28B, B28C.
- Lombillo, I., Villegas, L., Fodde, E., Thomas, C., 2014. In situ mechanical investigation of rammed earth: Calibration of minor destructive testing. *Constr. Build. Mater.* 51, 451–460. <https://doi.org/10.1016/j.conbuildmat.2013.10.090>
- Ma, C., Chen, B., Chen, L., 2016. Variables controlling strength development of self-compacting earth-based construction. *Constr. Build. Mater.* 123, 336–345. <https://doi.org/10.1016/j.conbuildmat.2016.07.017>
- Morel, J.C., Mesbah, A., Oggero, M., Walker, P., 2001. Building houses with local materials: means to drastically reduce the environmental impact of construction. *Build. Environ.* 36, 1119–1126. [https://doi.org/10.1016/S0360-1323\(00\)00054-8](https://doi.org/10.1016/S0360-1323(00)00054-8)

- Omar Sore, S., Messan, A., Prud'homme, E., Escadeillas, G., Tsobnang, F., 2018. Stabilization of compressed earth blocks (CEBs) by geopolymer binder based on local materials from Burkina Faso. *Constr. Build. Mater.* 165, 333–345.
<https://doi.org/10.1016/j.conbuildmat.2018.01.051>
- Van Damme, H., Houben, H., 2017. Earth concrete. Stabilization revisited. *Cem. Concr. Res.*
<https://doi.org/10.1016/j.cemconres.2017.02.035>

Samarawickrama, Sumanthri, et al (eds), 2018, "Sustainability for people - envisaging multi disciplinary solution": *Proceedings of the 11th International Conference of Faculty of Architecture Research Unit (FARU), University of Moratuwa, Sri Lanka, December 08, 2018 Galle* pp. 354–366. ©

THE EFFECTIVENESS OF STREET CHARACTERISTICS FOR CREATING A CITY IMAGE; A study of Galle road, Colombo

PERERA D.D.S.¹ & COOREY S.²

Department of Architecture, University of Moratuwa, Colombo, Sri Lanka

¹shiomala1993@gmail.com, ²sbacoorey@gmail.com

Abstract

The "Image" of the Asian city is associated with its street character, forms and patterns and it is distinctively different from its Western counterpart. The "Streets" play a dominant role in the formation of a city's unique identity. With the changes taking place in the urban development the street characteristics are undergoing significant changes having impact on the city image and its uniqueness. This study explores the importance of street character for enhancing the city image. Segments of streets along Galle Road, Colombo are investigated to observe the street characteristics and street users' perceptions on city image. Doorstep and street corner interviews were conducted among a random sample group. Findings revealed the most significant street characteristics such as width of the road, façade identity, visual exposure, functionality, boundary characteristics, physical form, activities, scale, visibility, height, unique shape, variation of setbacks, the sound, smell and greenery as important for enhancing and preserving the city Image.

Keywords: Asian city, street characteristics, city image

1. Introduction

When one thinks about the city, the element that first comes to mind is the 'street' (Jacobs, 1961). According to Strom (2007), streets create a direct network and link between the urban residents and city landscape (as cited in Cheng et al., 2017). Thus, Gehl and Jahn (2002) describe the street as an essential channel in an urban context that creates a network for movement. As discussed by (Lynch, 1960) path is a main element of the city. He defined path may be streets, walkways, transit lines, canals, railroads. Therefore, streets are part of the city and influencing the building up of the city image interconnecting all other elements of the city. Appleyard, Donald (1981) and Yeung, H. Wei Chug, Victor Savage, (1996) shows, that streets can be considered as the showcase of the city. It creates a perception and first impression about the city in the visitor's mind. Streets which are very attractive become popular adds to the city image. These types of streets demonstrate the positive characteristic of cities. (as cited in Hartanti et al., 2016).

Urban environment has grown in a less reasonable way since the beginning of the 20th century. More consideration has been paid to urban design in terms of functional aspects neglecting the real requirement of the inhabitant. Application of such concepts has resulted in disappearing the meaning, identity and character of 'street as a place'. As well as these facts caused to create gray streets and other isolated places, therefore early social bonds of the society were fractured. It has created human centered community. Therefore, "people in modern cities experiencing a feeling of isolation and loneliness, lack of social ties and hostility to community" (Jacobs 1961, Ton kiss 2005)

An imageable street of the city can be changed quietly but a great street will lose its identity and significance it has attained so far once changed and thus creates a negative impact on the image of the city. Similarly it also changes the perception of the person of the image of the city. (as cited in Hartanti et al., 2016) Always new street developments are followed by the growth of the city. Thus, new activities and attractive places are developed within it. Therefore, people can obtain many opportunities through the different street environments, hereby increasing the city image.

The rapid haphazard growth of the Urban environment has resulted in neglect in the meaning, identity and character of 'street' as a 'place' creating gray streets and isolated urban spaces. Therefore, "people in modern cities experience a feeling of isolation and loneliness, lack of social ties and hostility to community" (Jacobs 1961, Ton kiss 2005). The major cause is related to the lack of awareness and disregards of what constitutes architectural integrity and character of streetscapes among inhabitants and also professionals who are responsible for design, construction and maintenance of the urban context. Compacted haphazard developments, illegal construction, and disregard for Architectural integrity have caused chaos in urban streets of Colombo depriving its users of comfortable and pleasing streets for human activity. It is also damaging the image of the city.

Hence this paper aims to explore the important street characteristics for enhancing city image, the street characteristics that needs to be preserved and enhanced, based on the perceptions of the street users. Such study will lead to understanding the critical indicators for preserving street quality and city image, informing professionals on how cities are to be developed while sustaining and restoring the qualities that are critical for sustaining city image. The study is limited to a study of segments of Galle Road in Colombo; but a wider range of street zones varying in street types would be more beneficial to make inferences for the whole city of Colombo.

2. Literature Review

2.1. CITY IMAGE

Many factors contribute to making a successful and unique city image. Kevin Lynch (1960) identified three components of the environmental image: identity, structure and meaning. (Refer Table 1)

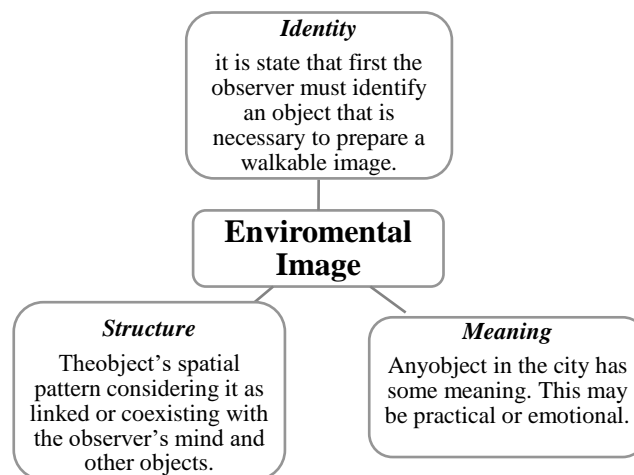

Table 1, Components of Environmental Image (Source: by Author)

Legibility: According to the Kevin Lynch (1960), Legibility is a factor that contributes towards the city image and visual quality within the city. Cities are easily identified by means of using districts, landmarks and pathways and thus can easily grouped into an over-all pattern. Hence, legibility or clarity cannot be provided a proper or definite meaning yet stands as an important property of attractive city. Legibility has a special importance when considering the size, time and complexity of the environment in an urban scale.

Imageability: According to Kevin Lynch (1960), physical qualities of the city create characteristic of identity and structure in the mental image. It can be identified as the 'imageability'. Thus, imageability of the physical objects of the city creates a higher opportunity in making a strong image in any observer's mind. Shape, color and arrangement of the physical object are also direct impacts to the mental image formed of the environment in the city. They help to create different identifications and a strong structure for the mental image.

2.2. MAIN ELEMENTS THAT IMPACT ON CITY IMAGE

Kevin lynch grouped these features into five main elements. (Refer Table 2). They are considered as the main part of the skeleton of the urban image of the city (Bentley, 1985).

Element	Descriptions
Paths	<ul style="list-style-type: none"> - A channel that is used for the observer's customary, occasionally and potentially movements. - Connect and arrange other environmental elements in the city. - If major paths lack of identity and consists a more confused structure, then the overall city image becomes difficult to perceive and thus will face various issues. <p>Ex: streets, walkways, transit lines, canals and railroads</p>
Edges	<ul style="list-style-type: none"> - Linear elements within the city are rather secondary and are nor used nor considered as a path by the user. - Act as the boundaries between two phases /linear breaks in a country or act as barriers which are penetrable and may conceal one region from another. - Adjacent orientation rather than organize axes. - Plays a role in holding generalized areas in the boundaries of a city together by either a wall or through water. <p>Ex: shores, railroad cuts, edges of developments, walls.</p>
Districts	<ul style="list-style-type: none"> - Demonstrate unique identification of the city. - Perceived by the observers as "inside of" while noted as those that carries a particular common identity amongst them. - Always consists an identifiable inside form. - Can be used as a reference from outside if seen from out of boundaries to the observer.
Nodes	<ul style="list-style-type: none"> - City consists of points or strategic spots where people can enter. - People travel through these intensive foci. - Being the reductions of some usage or physical character. - Some are focal and essence points in the city. - Identified as symbols of the city. - Considering overall nodes can be identified as the core. <p>Ex: Main junctions stop used as a break in transportation, a crossing or convergence of paths moment of shift from one structure to another, markets squares</p>
Landmarks	<ul style="list-style-type: none"> - Different types of points unlike nodes. - Do not enter the within them but identify them from an external space. - Have typical and different angles and distances and most of the elements' tops are small. - Help to find directions and thus act as symbols in the city. - Identified as local and are only visible to the restricted localities and are of convinced styles. - Increasing the value of the identity and structure, of the image of the city. <p>Ex: Some different shapes of buildings, signs, stores, mountains, Isolated towers, golden domes and grate hills</p>

Table 2, Five Main Elements of the City (Source : by Author)

2.3. STREET CHARACTERISTICS AND CITY IMAGE

Several street characteristics are defined by many scholars as important for establishing imageability. Such characteristics are summarized below. (Refer Table 3)

Physical Street Characteristics		
• Form	-	Lynch, K (1960)
• Shape	-	Lynch, K (1960), Appleyard(1981)
• Building Line	-	Worskett(1969)
• Building Height	-	Worskett(1969), Tugnuff&Robertson(1987)
Social Street Characteristics		
• Activities	-	Lynch, K (1960)
• Functions	-	Lynch, K (1960)
Visual Street Characteristics		
• Arrangement of Elements	-	Appleyard(1981), Rapoport A.(1987), Tucker (2004), Cullen(1961), Worskett(1969)
• Colors	-	Appleyard(1981), Cullen(1961)
• Textures	-	Tucker (2004), Cullen(1961)
• Pattern/ Style	-	Cullen(1961, Kropf(1996)
• Materials	-	Worskett(1969), Tugnuff&Robertson(1987)
Landscape Street Characteristics		
• Landscape Features	-	Appleyard(1981), Marcus & Francis(1998)
• Tree Canopy	-	Marcus & Francis(1998)
• Sky Line	-	Worskett(1969)
• Visibility	-	Lynch, K (1960)
• Surrounding Environment	-	Lynch, K (1960), Appleyard(1981), Rapoport A.(1987), Tucker (2004), Cullen(1961), Marcus & Francis(1998)

Table 3, Street Characteristics (Source: by Author)

3. Methodology

3.1. CASE SELECTION CRITERIA

Segments of Colombo – Galle Main road is selected for the case study as it connects to many streets, by roads, lanes in the city of Colombo. The area was divided into five zones within 1km distance based on a 10-minute walking distance. The study was repeated in the 5 selected zones namely: zone A, zone B, zone C, zone D, zone E (Refer Figure 1)

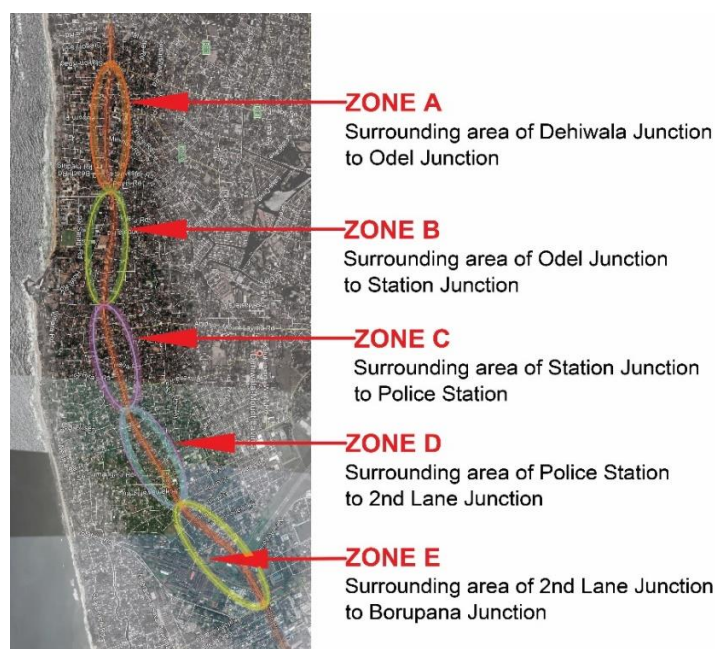

Figure 1, Case Study Area (Source: by Author)

3.2. DATA COLLECTION TOOLS

The views and memories about the local area in which they live in was explored using "doorstep" interview method. In addition, "Street Corner" Interviews were done to explore the perceptions of visiting population - street users on their views, memories of the street. The Data gathered were based on their perceptions on city image (streets, edges, nodes and landmarks). Further to the interview systematic observations were done to record the street characteristics of the five selected segments of the streets. The observations in all 5 segments were mapped.

4. Analysis and Discussions

4.1. MEMORABLE PATHS

Zone A - Kawdana Road has a considerable increment of width than other paths and the narrowness is smaller when compared to Auburn Side and Dudley Senanayaka Mawatha. The old buildings around the Kawdana Road also creates an impact in making the area memorable than others. It affects visually

The observed street characteristics are width of the road, surrounding environment and function.

Zone B - When considering the Wattarappala road, the width of it seems to be wider than other streets thus creating a more comfortable space for the users of the road. As it allows easy accessibility and more suitable space when considering the anthropometric characteristics as well. Further it was noted that it doesn't demonstrate a narrowness like Pinthaliya road, which was noted as a more insecure place due to its narrowness.



Figure 43, Entrance of the Wtarappala Road
(Source: by Author)



Figure 44, Entrtance of the Pinthaliya Road
(Source: by Auther)

The observed street characteristics are width of the road and visibility.

Zone C - In this section, The Templer's road and around that road demonstrates a very busy condition due to the situation of the public market in Mount Lavenia as well as the landmark for the bus halt of 255- Mount Lavenia- kottawa route, near that road.

Pirivena road is a memorable one. The main reason for this also was further noted as the constant use of the road by the students and members of the Engineering faculty in Rathmalana as well as the existence of the Pirivena at the close proximity. This area also depicts a satisfactory dimension in the road providing a wide space for both pedestrians and the vehicles.

The two religious statues alongside of the St. Rita road mainly has impacted in making memorable place. That statures are made spiritual feelings. Bandaranayake Mawatha isn't highlighted much because it is a narrow road which is small in width situated near the Police station.

The observed street characteristics are width of road, surrounding environment, visibility and activities. The existence of places for Religious significance as well as important community-commercial buildings such as the market has impact on memorability among the users.

Zone D - The Aththidiya road consists a wider pathway than other paths. Those characteristics also can be seen in Chakindarama road. In other paths there is an average width and a rather narrowness.

Situating next to the Maliban factory and among few medium sized and non-compacted buildings, spreading in a large area and existing of a color light can cause to being memorable of the width of main street near Aththidiya road. The increase of the width of the main street near the Aththidiya road also impacts to making the Aththidiya road memorable.

The observed street characteristics are width of the road and arrangement of elements.

Zone E - Even if , the Kadawala Mw has a rather wide pathway it has not become an effective reason to be memorable. The area consists of complex and compacted commercial buildings. From which a continuous building façade has been created around this path. Therefore, Kadawala Mw will be more memorable within the area. Similarly, the new airport road was identified as a memorable pathway because of the increase of the width. The situation of Rathmalana airport beside the Kothlawalapura Road is less memorable because of the narrowness of the road. Those reasons also create an impact to being memorable. Thus, comparatively the 5th lane is not highlighted, as the height of the buildings situated alongside is less but those located in the 4th lane is higher and has created a better impact in people's memory.

The observed street characteristics are width of road, functions, activities and surrounding environment.

Width of road, surrounding environment, functions, activities – in terms of commercial or religious significance, arrangement of elements and visibility are observed street characteristics of the all Zones.

4.2.MEMORABLE EDGES

Zone A - Mount- Lavinia Cemetery Boundary is linear boundary, use of greenery which is visually appealing to the passersby, creates a unique feeling which is less harsh and more aesthetically appealing to any pedestrian or motorist, entirely different view to the user when compared to cemeteries in the early days which had only a simple barbed wire or a short wall as a boundary that easily created the “eerie” feeling within a passerby making the space unwelcoming and more of negative atmosphere thus not allowing the passersby to walk peacefully and breaking down the continuity of the building façade.



Figure 45, Mount Lavinia Cemetery Boundary (Source : By Author)

The observed street characteristics are linear patterns, soft landscape features, surrounding environment.

Zone B - The tree line situated near the boundary wall near the court complex has become the most prominent edge. It plays role of noise barrier. This has created a shady area giving a tranquil atmosphere while preserving the dignified atmosphere of the court. This is the only area which includes greenery in a noticeable quantity in the neighborhood.



Figure 5, Boundary wall of Mount Lavinia Court Complex (*Source : by Author*)

Comparatively discussing it can be identified that though the boundary wall of St. Tomas College works as an edge, its memorable percentage has reduced due to its untidiness and unattractiveness.

The observed street characteristics are soft landscape features and tree canopy.

Zone C - Though the edges in zone C cannot be identified clearly the narrow linear edge opposite the Vision Care was suggested as one that demonstrates a boundary characteristic enhanced with its simple landscape with short green bushes creating a rather “cool” vibe.



Figure 6, Front View of the Vision Care (*Source : by Author*)

The observed street characteristics are arrangement of elements, soft landscape features.

Zone D - Fence of the Maliban factory is linear and demonstrates a boundary characteristic. The fencing that allows visual connection to the expanse of open space and greenery has played a major role in creating a significant impact in people’s minds.

The observed street characteristics are linear pattern, landscape features and visual connectivity.

Zone E - The tree line in the center line of the main street is identified as a significant edge. This consists trees of massive size which are enhanced by the carpets of grass underneath it. The road is divided into two parallel lines and thus demonstrates a boundary characteristic.



Figure 7, Tree Line middle of the Street (*Source : by Author*)

The boundary wall in Rathmalana airport is another highlighted edge in this zone. This acts as a long linear graphic wall thus, it has become an edge with a unique identity which stands out and instantly is perceived by those passing it. Boundary walls of technical college and Timber Corporation are long and linear yet are not easily identified separately as well as lacks attractiveness. This is due to the fact that both walls consist of the same characteristics in visual height and color.



Figure 8, Open Space in Front the Airport (Source : by Author)

The observed street characteristics are arrangement of elements, linear patterns, landscape features, and materials.

Surrounding environment, soft landscape features, linear pattern, arrangement of elements, tree canopy are observed street characteristics of all Zones in the study.

4.3.MEMORABLE NODES

Zone A - The most functional surrounding junction is observed along the Kawdana road. This is due to the fact that this junction was found to be one of the most memorable junctions compared to others. Most of the people in this area use this junction as a “village junction” thus it has developed the area near Kawdana Road as a commercial area or if stated in simple terms it has attained an identity of a typical junction in a village known as a “Handiya”. This junction stands out as a very busy area as many people uses the Kawdana Road as a shortcut. All other junctions are less noticeable because they are much more narrow roads when compared to the Kawdana Road.



Figure 9, Area of the Kawdana Road Junction (Source : by Author)

The observed street characteristics are the function and activities in terms of land use types such as active commercial activity.

Zone B - The building facade alongside the Wattarappala road junction consists of rather small buildings. There is considerable variation in building façade, and a considerable amount of open space is created. Above factors have also created an impact to the Wattarappala road to be the most memorable among many junctions. This junction has become very busy due to the frequent use of motorists. Situation of almost all other memorable paths mentioned above can be a reason for being memorable.

The observed street characteristics are surrounding environment, visibility, building height and functions.

Zone C - The Templer’s road junction and Station junction around that road demonstrates a very busy condition due to the situation of the public market in Mount Lavenia as well as the landmark for the bus halt of 255- Mount Lavenia- kottawa route, near that road. A vehicle congestion can be seen because of the color light at the Templer’s road junction.



Figure 10, Templers Road Junction
(Source : by Author)



Figure 11, Station Road Junction
(Source : by Author)

The observed street characteristics are surrounding environment, activities and functions.

Zone D - The Aththidiya road junction has become the most memorable one due to be a very busy junction and being a three-way junction made by well using the space. The dimensions of this junction have also created a prominent image to it within those who see it. The aroma of the freshly baked biscuits is experienced near the Maliban factory, which is the main reason for this junction to be in many people's memory.

The observed street characteristics are smell of surrounding environment, visibility and functions.

Zone E - The junction that's situated near the Kadawala Mw has become popular as Belekkade junction due to the existing situation within this junction that has turned out to be more of a daily market area. Therefore, this junction always demonstrates a busy condition crowded by the residents as well as those regular outsiders. It should be taken into consideration that the characteristic created in this area with the small boutique type shops and compacted nature has also contributed in making this a memorable junction. Thus, it has stood out as one of the most memorable locations in the zone.

The airport junction which has connected to the new airport Rd has become memorable due to the surrounding environment. Therefore, an open space has created around the area of airport which is also a reason to making the area memorable. This junction is also popular due to the situation of the Kothalalwala Defense University and Telecom.



Figure 12, Kadawala Mawatha Junction
(Belekkade Handiya) (Source : by Author)



Figure 13, New Airport Junction
(Source : by Author)

The observed street characteristics are surrounding environment, activities and functions.

Surrounding environment, functions, activities, visibility and building height are observed most dominant street characteristics of the all Zones in the study. These street characteristics are directly influence to the create memorable nodes.

4.4. MEMORABLE LANDMARKS

Zone A - The cemetery as a memorable landmark, in present, the cemetery has picturesque, attractive landscaping with flowers and those highlights the cemetery as a more appealing place. This also effects the emotional bond between people and cemetery in a positive way. This is further enhanced by the quiet and calm environment around the cemetery.

Arpico Super Centre on the other hand depicts a more memorable space than the cemetery discussed above. The main reason for that was observed as the color of the building, and the volume and scale bring a specific look. Thus, it has become a memorable landmark in the area.



Figure 14, Entrance of the Mount Lavinia Cemetery (Source : by Author)



Figure 15, Building Form of the Arpico Super Center (Source : by Author)

The observed street characteristics are landscape features, surrounding environment, shape, volume, color, building height, visibility.

Zone B - The huge Mara tree in the middle of the three-way junction is highlighted as a prominent landmark, while providing a unique form at the junction by its shape, characteristics and color of flowers. The Mara tree due to its prominent features and height, is a well visible element to any person even from a 100m distance specially when looking towards Galle from the Colombo side it is easily noticeable and thus creates an instant welcoming impression in a passerby.

Mount Lavinia court complex has become a memorable element due to the tree line in front of it as discussed previously. This has emphasized the silent nature around the court complex.



Figure 16, The Mara Tree in the Odel Junction (Source : by Author)



Figure 17, Entrance of the Mount Lavinia Court Complex (Source : by Author)

The KFC building is also considered a memorable landmark due to the building structure, building faced variations and colors used. The outdoor gathering space near the KFC favors the characteristics that highlights this building.

It is also noted that the Dharmendraramaya temple was a place which was in the memory of majority of the people. It can be concluded that the Dakshinarama temple has become memorable due to the good visibility of the stupa to the road, the white color and the smell of incense sticks that bells from the temple.



Figure 19, Dharmendrarama Temple
(Source : by Author)



Figure 20, Building Form of the KFC Building
(Source : by Author)

The observed street characteristics are form, shape, color, building height, surrounding environment, visibility, tree canopy, landscape features and functions.

Zone C - The Buddha statue and the Christian statue which are situated alongside the beginning of St. Rita road have taken the spaces of higher percentage of people's memories due to the unique identity that the statues have added to the road. The "memory" of this is also enhanced by the religious statues.

Nawaloka Clinic Center has become the most outstanding building in that area due to its massive height, but attractive colors or a form cannot be seen in that. Except all these, commercial buildings such as McDonalds, Pizza Hut, Keels Super Center and Chinese Dragon have remained in people's memories due to their different colors and different forms. Sometimes the aroma around them has also impacted in making the place memorable as most of them are restaurants.

The observed street characteristics are building height, smell of surrounding environment, visibility and functions such as places of religious significance.

Zone D - Building form isn't the reason for the Maliban factory to be highlighted. But the garden and the lawn area opposite it has created a positive impact in identifying the building as a unique landmark. The aroma of the freshly baked biscuits is experienced near the Maliban factory, which is the main reason for this junction to be in many people's memory. In addition to that, the statues opposite to the Maliban factory also helps to enhance the area as a landmark. When considering the statues apart from the building, people don't identify the junction as a landmark due to the insufficiency of its scale.

In addition to that, even if the scale of the Buddha statue which is situated in Silva place is not large, it stands out as a prominent landmark as a Buddha statue and the white color also was identified as a reason to enhance this statue. But this is not visible directly to a person that walks in the street because Silva place is a narrow path which doesn't consist a wide road.

The Samsung building is a commercial building which is less memorable as a landmark because the height and the scale of it, is not in a considerable level as it blends with the other buildings around it when considering its height where as its blue color has created the significance in the building and thus highlighting it amidst the other similar buildings.

The observed street characteristics are color, arrangement of elements, smell of surrounding environment, visibility and functions.

Zone E - Rathmalana airport is highlighted in zone E also as a landmark because of its large scale and the inexistence of the huge buildings and trees which all in all creates an open area. In this area, along the edge of the center road divider line, there are no trees except only the lawn has been maintained. Therefore, a more open space has been created around the airport than other places. Impact of all these factors, has made the airport to a memorable place with a unique identity.

The massive Buddha statue which is situated near the station Rd in Belekkade junction to be one remembered by most of the passersby. Though there exists the Dharmendraramaya temple near this

statue it is not remembered by most people while the statue has captured all the attention of this particular place, because of its considerable height and scale. Apart from the buddha statue, the form of the “Pilima ge” also contributes in creating the memory within this area.

The blind school in Rathmalana has been noted as a prominent and well-known landmark in almost every person’s mind who passes the area. As it is a special school situated at the Rathmalana junction the knowledge of the speciality of the school also creates an awareness in specially the drivers minds when passing the area, making them drive more consciously thus subsequently turning into a memorable place known by many.

The Lanka Sathosa building which is a commercial building that consists of a large parking area in front of it which attracts the passerby though the building doesn’t have a strong attractive characteristic the open space amidst the other walls and building facades has implied a specific “change” along the road.



Figure21, Buddha Statue in the Belekkade Junction
(Source : by Author)



Figure 22, Building Form of Lanka Sathosa
(Source : by Author)

The observed street characteristics are form, shape, color, building height, landscape features, surrounding environment, visibility and functions.

Form, shape, color, building height, surrounding environment, visibility, tree canopy, landscape features and functions are observed most dominant street characteristics of the all Zones in the study. These street characteristics are directly influence to the create memorable Landmarks.

5. Conclusion

The study revealed several street characteristics associated with inhabitant’s memory of the city which is noted as important characteristics for sustaining the city image.

Road Width and Building Heights: open wider street scales, with good visual accessibility are memorable and important for creating a memorable street. Façade Identity: in terms of the treatment of facades such as physical form, scale, visibility, height, unique shape, variation of setbacks play an important role in the perceptions of street users. Functionality and Activities: Places of religious significance, communal significance and also commercial significance are important for lasting memory of pedestrians. Boundary characteristics: Street edges lined with trees, greenery and landscaping are the key characteristics for city image.

These characteristics were found to be the most significant characteristics of streets that enhanced their memory of streets and City Image. Thus, such characteristics need to be preserved, enhanced and considered in the development strategies of the City of Colombo. But this study is limited to study of segments of streets from Galle Road in Colombo. Further expanded studies of other parts of Colombo are required for confirming the above for the whole of the city of Colombo.

6. References

- Appleyard, D. (1980). Livable Streets: Protected Neighborhoods? The ANNALS of the American Academy of Political and Social Science, 451(1), 106–117. <https://doi.org/10.1177/000271628045100111>
- Bentley, I. (1985). Responsive environments: a manual for designers. London: Architectural Press.
- Cheng, L., Chu, S., Zong, W., Li, S., Wu, J., & Li, M. (2017). Use of Tencent Street View Imagery for Visual Perception of Streets. ISPRS International Journal of Geo-Information, 6(9), 265. <https://doi.org/10.3390/ijgi6090265>
- Hartanti, N. B., Martokusumo, W., Lubis, B. U., & Poerbo, H. W. (n.d.). The Quest for Urban Identity: Influence of Urban Morphological Development to the Imageability of Bogor City Streets, 10.
- Lynch, K. (2005a). The image of the city (Nachdr.). Cambridge, Mass.: MIT PRESS.
- Lynch, K. (2005b). The image of the city (Nachdr.). Cambridge, Mass.: MIT PRESS.
- MEETIYAGODA, L., & MUNASINGHE, J. (2009). Towards Great Streets: An Empirical Approach to Study a Streetscape, 01(02), 18.
- Tucker, C., Ostwald, M. J., & Chalup, S. K. (2004). A method for the visual analysis of streetscape character using digital image processing, 7.

Samarawickrama, Sumanthri, et al (eds), 2018, "Sustainability for people - envisaging multi disciplinary solution": *Proceedings of the 11th International Conference of Faculty of Architecture Research Unit (FARU), University of Moratuwa, Sri Lanka, December 08, 2018* Galle pp. 367-376. ©

IDENTIFICATION OF FUNCTIONALITY AND USABILITY ASPECTS OF TRADITIONAL PAATHRAYA' IN SRI LANKA

THILAKARATHNA. K.C.M.¹ & RANASINGHE. W.M.N.D.²

University of Moratuwa, Katubedda, Sri Lanka

¹chalana.madhuwantha@gmail.com, ²dilshaniranasinghe80@gmail.com

Abstract

Functionality and usability can be identified as main key factors under the field of Product design. Traditional products have survived for many years in the history of a particular region or culture. In the perspective of product design, traditional products have gone through stages of designing and tested continuously with actual context. Therefore, those traditional products can be identified as well-designed products even though there is no any particular person to identify as a designer for them. Sri Lankan culture is believed to be more connected with the nature and sustainable concept according to social scientists, historians, archaeologists and folklore explorers. `Paathraya` is a traditional identical product that used by Buddhist monks not only in Sri Lanka but in other countries also. Therefore, it has a psychological platform combined with its physical characters. *Paathraya* is known as alms bowl in English, *Patra* in Sanskrit, *Patta* in Pali and *Hatsu* or *Hachi* in Japanese. As Product Designer, researching about traditional *Paathraya* of Sri Lanka gives exposure to the design principles and elements, material identification, product functionality and usability. The Research is carried out as an ethnographic research. Empirical Data is gathered by observing Museum collections and *Paathra*, which are currently used, interviewing archaeologists, Buddhist monks, artisans, potters, designers, scientists, sociologists by experimentation and analysing chronological development of *Paathraya*. Secondary data are collected through books and journals to enhance the functions, interpretation and design theories. Research will be based on lay *Paathraya* to explore the importance of material, design and its usability. Research Findings are behaviour of the product in tradition and in practise, character, norms and the message it conveys. It was found that *Paathraya* provides knowledge to define functionality and usability with its physical and psychological character.

Keywords: *'Paathraya', Culture and Tradition, Functionality, Usability, Product Design*

Introduction

Traditional products have survived for many years in the history of a particular region or culture. In the perspective of product design, traditional products have gone through stages of designing and tested continuously with actual context. Therefore, those traditional products can be identified as well-designed products even though there are no designers are identified for those products. Designer Dieter Rams has said that a good design is innovative, making a product useful, aesthetic design, making a product understandable, honest, unobtrusive, long lived, consistent in every detail, environmentally friendly and as little as possible. (*Objectified*, n.d.). Therefore, most of the traditional products can be identified as good designs. When identifying traditional products, *Paathraya* can be identified as an iconic product. Sri Lanka also have a culture, which is in-cooperated and connected with *Paathraya*. Merely without being only a physical product, *Paathraya* is connected to the life style of monks, believes and psychology of people.

Functionality and usability aspects have been main parts of product designing from the beginning of professional product designing. Most of the theories regarding those aspects have been build up taking existing products as examples. However, products, which are much older, may have considered those aspects. With the globalization and industrialization, the countries experience products, which are alien to the culture, tradition and society. (UNESCO, 2018) Those products being alien and not suitable have and will create issues to that context. Therefore, it is important to explore and promote products, which are not alien to that context.

The world is having environmental disasters harming every living being in Earth. After understanding the consequences of harmful products and systems, world is moving towards a greener, eco-friendly and sustainable path. On a vision of making a better world and understanding mistakes through our past, it is very interesting to find out how traditional products have been used or still being used and what present and future product designers can extract from them. Adapting human life styles according to traditional products or adapting traditional products in to present human life style may solve most of the human issues in the present and in the future. Therefore, finding out how functionality and usability aspects are applied on products that have survived through the history, is important.

Functionality and Usability

There are three elements to concern when concerning a product with interaction. Those are Functionality (Product), Usability (Interaction) and Experience (User Experience). (McNamara & Kirakowski, 2006). Design considerations of different design fields may vary but in a broad view of understanding and analysing them, they all can be understood and categorized.

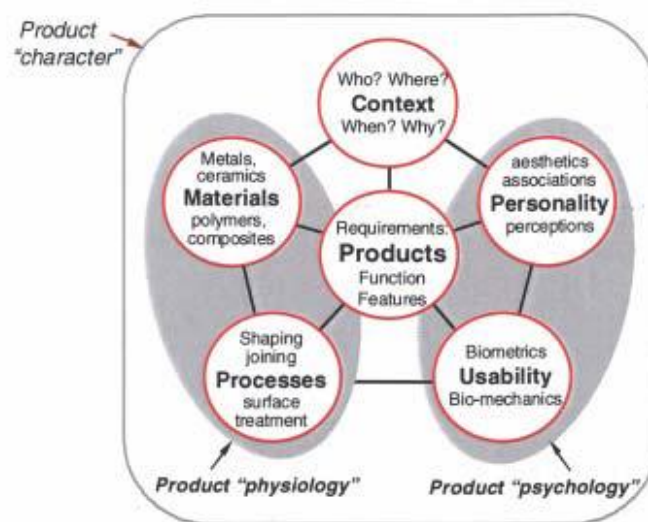

Figure 46-Elements of Products by (Source: Ashby & Johnson, 2003)

Object of Design is the relationship between the user and the product. (BÜRDEK) This enable us to think in a common design procedure view and separate design field views. Designers intention from designing a product, service, interface or any other modes of design outputs, is making it being used by the user ergonomically, in a user-friendly method, giving a pleasure to the user. Designer embed functions in a product, which will be usable to the user. Therefore, it is a relation between designer's intention, contribution and user's expectations.

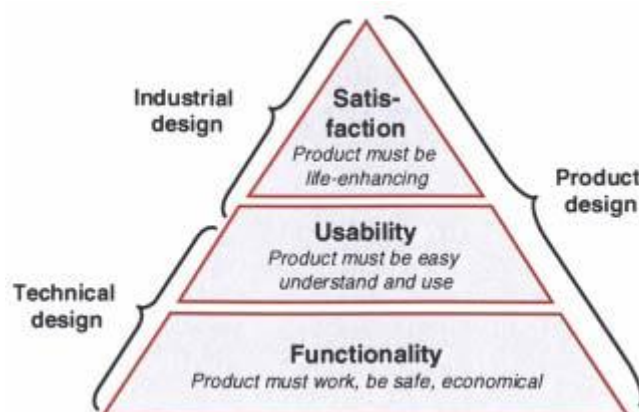

Figure 47- Main Considerations of Designing products (Source: Ashby & Johnson, 2003)

When designing a product, designers follow principles, elements and theories of design. Functionality and Usability can be found among many of those practices. In the paper (Kesteren, Stappers, & Kandachar, 2005) it compares and states the terminologies as stated by several other researchers regarding design elements. Those researchers are globally recognized resource persons regarding design.

Terminologies	By Roozenburg & Eekels	By Ashby	By Muller	By Ashby and Johnson
Function	Function	Function	Function	Function, Technical Functionality
Materials	Physical and Chemical Form	Materials	Materials	Materials (dimensions: engineering, use, environment, aesthetics, personality)
Shape	Spatial Form	Shape	Shape	Form
Manufacturing Process	Manufacturing Process	Process	Process/Work	Processes (joining, shaping, finishing)
Use	Use	-	Use	Use
Product Personality	-	-	-	Product Personality

Further they stated that those six elements of design combine with each other to perform special tasks. Accordingly, 'Function' is the aim of the product and the way it operates. The function of a product is the purpose it is made for. 'Use' is the designed interaction the user can have with the product.

Functionality can be defined this way: "The ability of an interface or device to perform according to a specifically defined set of parameters." (Clench, 2013) Supports (Spacey, 2017). A product's functionality enables product to address user needs. For an example, a watch's functions may be Alarm function, World time function, Compass function, Barometer function, Altimeter, Stopwatch function, Thermometer function, Airplane Mode, Tide graph function, Tachymeter, Phone Finder and Pairing. The purpose of using those functions can be varied to each user.

The simplest definition of usability is as follows according to the International Standardization Organization (ISO): "The extent to which a product can be used by specified users to achieve specified goals with effectiveness, efficiency, and satisfaction in a specified context of use."

Designers have explained the meaning of usability in different fields of design to cover different dimensions of people interactions with the product. Traditionally, user-centred design has tended to concentrate on usability. Traditional products also have embedded usability as ergonomics, cognitive, emotional, social and cultural aspects.

The differences between functionality and usability can be explained from this statement. 'simple way to think of the difference between functional testing and usability testing is that functional assesses whether or not the product works the way it should, whereas usability addresses whether or not the end user can access those functions and successfully use the product.' (Group, 2018). Most of the product developers explain the difference between Functionality and Usability as "Functionality = the what (features), Usability = The How (interactions)" (Short, 2016). Therefore, it is clear that Functionality and Usability may overlap each other in some occasions but they are two separate concerns under designing.

Reusing is another area, which comes under functionality and usability that reinvent the form and that creation. It is a way of understanding another perception or discovering other ways of that product's usability. Some may be multi-functional in a way of catering for all or some needs. Some products are designed as multi-functional, targeting a reuse, but some are not. User may find another ways to do things or other things to do with it.

Through all these understandings, it will be easy to define Functionality and Usability according to the study. Therefore, Functionality is defined and embedded in to a design by the designers, creators and

artisans of a product. Functionality will guide and show how every element in the product will work and how to use the product. Usability is more connected with the user. Designer may understand what the user actually need or the user may find any solution, which is defined for any other function. Those products will be as a design brief for a designer to create the best suitable design for that purpose. Functionality is how a designer expect a product to be used and Usability is how a product can be used in a number of ways. There are many evidences of unorthodox ways and uses of products. These factors are much important for the development of a product.

Identification of *Paathraya*

To explore the design elements such as functionality and usability, it is better to analyse a product as a reference. Charles and Ray Eames identified *Lotas* of India as simple, greatest and most beautiful among the objects they encountered on their visit to India. They have given a guideline to follow when designing reference to *Lotas*. (Eames & Eames, 1958) *Lotas* have been attached to the Indian culture and evolve as a perfect product design for that context. Likewise, *Paathraya* can be identified as a good product design. *Paathraya* expresses not only a story about that vessel but also a story of a culture, tradition and a life style. It can be identified as a magnifier, which can be used to get a clear and magnified view of life.

Use of Design Elements in *Paathraya*

Frequently, natural forms continued to be the ideal model for a particular purpose, with early artefacts made from metal or clay often shaped in forms identical to the natural models from, which they originated. In 1896, in an essay entitled 'Tall Office Building Artistically Considered', the American architect Louis Sullivan wrote: 'It is the pervading law of all things organic, and inorganic, of all things physical and metaphysical, of all things human and all things super-human, of all true manifestations of the head, of the heart, of the soul, that life is recognisable in its expression, that form ever follows function. This is the law.' (Heskett, 2002) It has been explained by taking animals' survival elements as examples. A vessel must be shaped for its purpose. Secondly, the shape must arise naturally from mode of manufacture and exhibit advantages of properties of clay. Thirdly, it should not interfere with its usefulness, appropriate in amount and character to the purpose and material it is made of. Fourthly, it should have a smoothened surface and elaborate refinements. (Coomaraswamy, 1979)

Manufacturing Process of *Paathraya*

The manufacturing methods of traditional earthenware vessels of Sri Lanka are mostly wheel throwing. Pottery wheel, which used is a hand wheel. It is wheeled by a person (mostly by the wife) and vessels, is formed by another person (mostly by the potter). Other methods, which have been to make pottery, are coil and pinch methods. Most of the vessels are fired at low temperature in a simply packed kiln. The industry has been affected by lack of raw materials, fuel problems and the treat from metallic vessels.

Through the techniques of manufacturing, the artisans have been able to achieve qualities required to the purposes of the vessels.

The main problem with pottery is that it is very fragile. While well-fired clay is virtually indestructible, if bumped or dropped it will shatter. Not only that, but also clay is very useful in keeping rodents and insects out and as it can be set directly into a fire, it is very popular.

Use of Design Elements to the Product Functionality

The anatomy of a vessel can be separated into three distinct parts: orifice, body and base. Other than the main elements, there may be a neck, collar, spout, lid and handles. In the context of *Paathraya* Orifice, body and base can be identified its main elements.

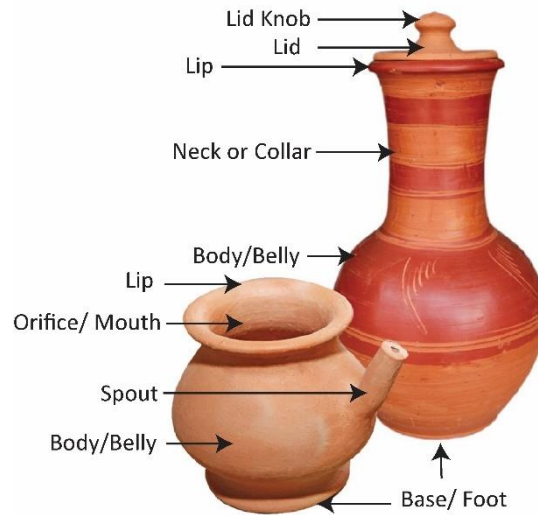

Figure 48- Elements of a vessel (Source: Author)

Orifice- The orifice is mouth of the vessel, and is subject to many different embellishments, mostly for functional use. The main function of the orifice is transferring the substances in and out. Pouring, handling, protecting and hanging are other functional factors. The opening is further divided into two categories:

Unrestricted: an unrestricted orifice is when; the opening is equal to or greater than the maximum diameter of the body. **Restricted:** contrarily, is when, the opening is less than the maximum diameter of the body.

Both restricted and unrestricted *Paathra* can be seen.

Body- The body is the area between the orifice (opening) and base (bottom). The maximum diameter of a vessel is usually at the middle of the body or a bit higher. Body is where the substance holding is done. Body is also known as the bell since it made to hold a considerable amount of substances.

Base- The base is the underside of the vessel. It is generally flat or slightly rounded so that it can rest on its own. *Paathraya* does not have a separate base but the underside of the body act as the base of the vessel.

Findings and Conclusion

'*koppaya*'(cup) – functions of these vessels are basically drinking and eating. It consist of unrestricted orifice and hemispherical body. The lip has been thinned. These vessels have been used to store grave goods as their secondary purpose. '*mandava*' or '*pingaana*'(plate) - these vessels have been used for the eating purposes. They consist of wide and unrestricted orifices. Keeping grave goods has been a secondary purpose of these vessels. '*Paathraya*' (bowl) is primarily for offering food for Sanga. It is a bowl with inverted flat lips, opened or restricted wide orifices and globular body. '*Thatiya*' is a dish with wide orifice, rolled lip and bottom with a foot ring. It has been used to eat food, cook food and cover other vessels.

A single vessel has multiple uses of functions and usability and vice versa. The main function of a single vessel may change through time.

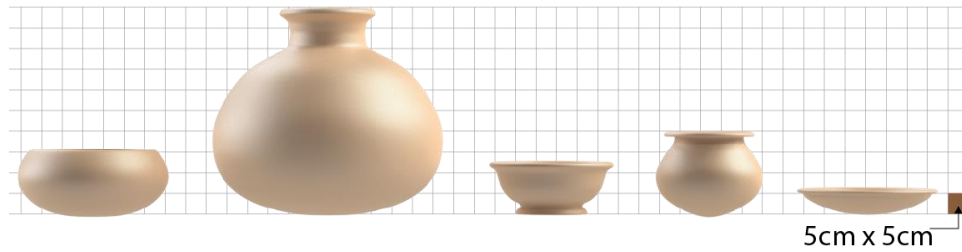

Figure 49- 'Paathraya, Kalaya, Mati koppaya, Muttiya and Kabala' (Source: Author)

Paatraya is a multi-functional product in the possession of Buddhist Monks. It is one of eight essential products ('*Ata Pirikara*') of Monks. '*Ata Pirikara*' are traditionally in Theravada; a bowl; a double robe; an upper robe; a lower robe; a belt (to fix the robe around the waist); a sewing needle – with thread (to mend his robes); a razor (to shave the head and the beard); a water filter (to use water without killing living beings). In '*Vinaya Pitakaya*', it has described what to use as a bowl, how to use it, when to use it and a detailed laws and customs related to the bowl. Iron bowl and Clay bowl are the only accepted bowls. There are three kinds of bowls. They are Large (high), Medium (middle) and Small (low) bowls. In ancient times, Monks have accepted one fourth of the volume of the vessel by uncooked rice. Monks used to live in forests kept all the robes inside the bowl and kept it away from the rain or the small animals like insects and mice. Thickness of the '*Paathraya*' may vary from 2.4mm to 7.4mm. Most of the murals found in Sri Lanka contain drawings of '*Paathra*'.

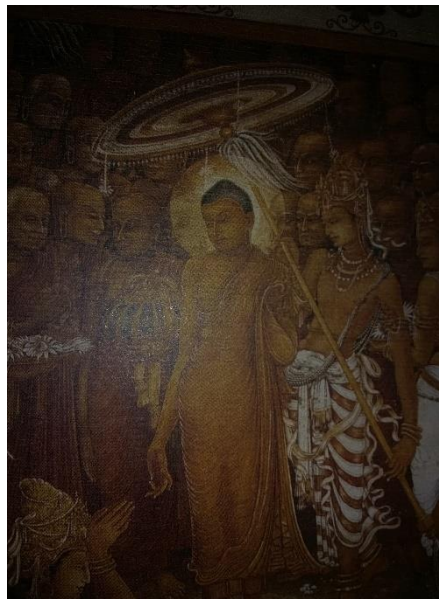

Figure 50- Mural depicting Lord Buddha (Source: Kelani Viharaya)



Figure 51- Lord Buddha with the 'Paathra' (Source: Kelani Viharaya)



Figure 52- Mural depicting Gods carrying 'Paathras' (Source: Ridee Viharaya)

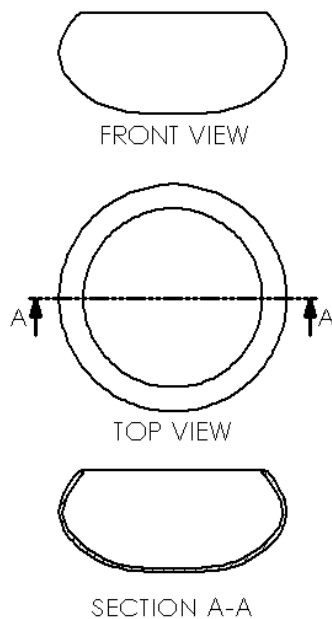

Figure 53- 'Paathraya' (Source: Author)

As Buddhism teaches that 'everything is not forever', *Paathraya* also damages and breaks. 'Kabala' has been a *Paathraya*'s reusing stage. After products' wide globular belly has been damaged, as the monks cannot use it as a bowl, 'Kabala' has been built from those. The word meaning of the 'Kabala' is 'old and broken'. It is used to bake 'Roti', bake spices and to put charcoal and use it as incense burner and a heat source.

Achieving thermal control, reducing weight, making the vessel ergonomically and producing a product that deeply connected to the people, culture and society has been mastered by the artisans or potters. Each vessel consist of enormous knowledge regarding product design with every theories and principles explained.

Paathraya shows clear evidences and examples for the definitions of functionality and usability. The qualities of the products have been achieved by the material, shape, form, thickness and usage. All the design theories and principles can be explained through traditional products and more theories and principles can be evolved

A multi propose vessel may be the best approach to a green product due to limited environmental impact with resource extraction, manufacturing, transporting, using and disposing.

The material itself has added a cultural and religious value to the product. The fragility of *Paathraya* intend the user to be more careful and patience. That is exactly the image of monks. The restrictions mentioned in '*Vinaya Pitakaya*' are stated to protect the product as well as the culture it creates. The product is minimalistic as the life should be according to the Buddhism. It is known as '*alpeechchathwaya*' in Sinhala Language.

Paathraya is a product, which should be hold with both hands or hold with the support of the body. Therefore offering of a *Paathraya* will be by both hands, which is an accepted behaviour. The orifice of *Paathraya* is covering the content inside, which makes others not to feel greed. *Paathraya* also build up the behaviour of being satisfied with what you have.

Paathraya has a globular body with no sharp edges. It makes *Paathraya* easily cleanable and handled. The three sizes of *Paathraya* makes the product ergonomically matching for any user and the quantity of the content is ergonomically designed.

Vinaya Pitakaya states that *Paathraya* should not be kept on a chair, bed, edge of out stage, uncleaned floor, even on lap or hanged by a stick. *Paathraya* and Buddhist culture is bonded to each other. Buddhist culture has been formed according to *Paathraya* than vice versa.

Paathra Thaliya is the robe used to carry *Paathraya*. It has been developed to hang *Paathraya* on a shoulder and carry it in front. *Paathraya* is covered by '*Siwura*' (robe) or hand. From a psychological perspective, it makes *Paathraya* prioritized and important. From that, a symbolic meaning is given to the people.



Figure 54- Holding of *Paathraya* (Source: www.you2repeat.com)

Paathraya is a universal product, which meant equality of every human being. Sangamiththa thero has brought '*Sri Maha Bodhiya*' to Sri Lanka in a *Paathraya*. *Paathraya* is an icon resembling equality, minimalistic lifestyle and calmness.



Figure 55- A large *Paathraya* being used in '*Aluth Sahal Mangalyaya*' (Source: www.lankatag.com)

Products should not be over designed. The history of *Paathraya* depict that it was and is the most suitable design for centuries of years. Therefore, any changes done to the vessel will be changing of a culture and tradition. If it is essential, it should be done with great care and proper rationale.

References

- Ashby, M., & Johnson, K. (2003). Art of Material Selection. *MaterialsToday*, 27.
- BÜRDEK, B. E. (n.d.). Objects : In between language. *OBJECTS & COMMUNICATION*, 42-51.
- Clench, M. (2013, October 23). *The Difference Between Usability and Functionality*. Retrieved from Everything is Content: <https://everythingiscontent.wordpress.com/2013/10/23/the-difference-between-usability-and-functionality/>
- Coomaraswamy, A. (1979). *Medieval Sinhalese Art*. New York: Pantheon Books.
- Cooper, E. (1984). *Ten Thousand years of Pottery*. Quarto Publishing Limited.
- Dalupotha, M. K. (2001). 'Game wagathuga'. Colombo: Fast Publishing(Pvt) Ltd.
- Dalupotha, M. K. (2001). 'Kethe Wagathuga'. Colombo: Fast Publishing(Pvt) Ltd.
- Dalupotha, M. K. (2003). 'Watapila'. Colombo: S.Godage and Sons.
- Deraniyagala, S. (1984). A Classificatory System for Ceramics in Sri Lanka. *Ancient Ceylon No 5*, 109-14.
- Dictionaries, O. (n.d.). *English Oxford Living Dictionary*. Retrieved February 02, 2018, from <https://en.oxforddictionaries.com/definition/tradition>
- Eames, C., & Eames, R. (1958). *The India Report*. Ahmedabad: National Institute of Design.
- Ellawala, H. (1969). *Social History of Early Ceylon*. Colombo: Department of Cultural Affairs.
- Europe, C. (2018, May 30). *Functionality examples*. Retrieved from CASIO: <https://www.casio-europe.com/euro/products/watches/functionality-examples/>
- Foundation, T. I. (2017, February 25). *Design Principles*. Retrieved from Interaction Design Foundation: <https://www.interaction-design.org/literature/topics/design-principles>
- GOODWIN, N. C. (1987). FUNCTIONALITY AND USABILITY. *Communications of the ACM*, 229-233.
- Group, Q. (2018, May 30). *Functional Testing vs. Usability Testing*. Retrieved from Qualitest: <https://www.qualitestgroup.com/white-papers/functional-testing-vs-usability-testing/>
- Hauffe, T. (1998). *Design*. Laurence King Publishing.
- Henrickson, E. F., & McDonald, M. M. (1983). Ceramic Form and Function: An Ethnographic Search and an Archeological Application. *American Anthropologist*, 630-643.
- Heskett, J. (2002). *Design- A very short introduction*. New York: Oxford University Press Inc.
- Ilangasingha, A. (2007). 'Game withthi'. *Helagosa*, 92-98.
- Jirousek, C. (1995). *Principles of Design*. Retrieved from Art, Design and Visual Thinking: <http://char.txa.cornell.edu/language/principi/principi.htm>
- Jordan, P. W. (1997). Human factors for pleasure in Product Use. *Applied Ergonomics*, 25-33.
- K.Arunasiri. (2007). 'Hela Karmaantra'. *Helagosa*, 184-185.
- Kesteren, I. v., Stappers, P. J., & Kandachar, P. (2005). Representing product personality in relation to materials in a product design problem. *Design Elements*, 2-5.
- Knox, R., & Paulusz, J. H. (1681). *A historical relation of the island Ceylon*. Colombo: Thisara Publishers LTD.
- Kumara, H. C. (2006, March). Industrial production in Sri Lanka before. *Sambhasha*, pp. 1-9.
- March, A. (1994, October). *Usability: The New Dimension of Product Design*. Retrieved from Harvard Business Review: <https://hbr.org/1994/09/usability-the-new-dimension-of-product-design>
- Martin, T. A. (1997). *USA Patent No. US 5908257 A*.
- McNamara, N., & Kirakowski, J. (2006). Functionality, Usability and User Experience: Three areas of concern. *Interactions*, 26-28.
- Merriam-Webster, I. (2018, June 29). *Dictionary*. Retrieved from Merriam-Webster: <https://www.merriam-webster.com/dictionary/earthenware>
- OneKind. (2016). *onekind.org*. Retrieved from Onekind: <https://onekind.org/animal-behaviour/personality/personality-in-primates/>
- Parsons, T. (2009). *Thinking: Objects-Contemporary approach to Product Design*. Lausanne: AVA Publishing.
- Project, S. o. (2013, October 01). *The Story of Solutions*. Retrieved from <http://storyofstuff.org/movies/the-story-of-solutions/>
- Rice, M. (1987). *Pottery Analysis*. Chicago: University of Chicago Publishers LTD.
- Rice-university. (1999-2017). *Animal forms and functions*. Retrieved from OpenStax CNX.: <https://cnx.org/contents/RFA7VJpM@8/Animal-Form-and-Function>
- Salvi, S. A. (2015, August 29). *Materials for kids and toys*. Retrieved from Slideshare: https://www.slideshare.net/SergioAntonioSalvi/sergio-antonio-salvi-materials-for-kids-and-toys-lecture-extract?qid=ff3ce5bb-21d6-4784-85d6-61ce17fbf401&v=&b=&from_search=2
- Short, V. (2016, July 20). *Functionality Vs. Usability: The 'Chicken or the Egg' Debate of UX Design*. Retrieved from atlantictb: https://www.atlantictb.com/blog/functionality_vs_usability_ux/
- Silva, N. D., & Dissanayake, R. B. (2008). *A Catalogue of Ancient Pottery from Sri Lanka*. Kelaniya: Postgraduate Institute of Archaeology (University of Kelaniya).
- Solan, W. R. (2009). *USA Patent No. US 20110008094 A1*.
- Somadeva, R. (2006). URBAN ORIGINS IN SOUTHERN SRI LANKA. *Studies in Global Archaeology* 5, 201-240.

- Spacey, J. (2017, February 03). *Design: Usability vs Functionality*. Retrieved from Simplicable:
<https://simplicable.com/new/usability-vs-functionality>
- Sparkes, B. A. (1996). *The red and the black. Studies in Greek pottery*. London and New York: Routledge.
- Staff, P. (2015, September 03). *History of the world in 52 packs*. Retrieved from PackagingNews:
<https://www.packagingnews.co.uk/features/history-of-the-world-in-52-packs-6-toothpaste-tubes-03-09-2015>
- NESCO. (2018, May 31). *Traditional craftsmanship*. Retrieved from UNESCO: <https://ich.unesco.org/en/traditional-craftsmanship-00057>
- Wickramasingha, M. (1934). *'Sathwa Santhathiya'*. Colombo: Sarasa (Pvt) Ltd.

Samarawickrama, Sumanthri, et al (eds), 2018, "Sustainability for people - envisaging multi disciplinary solution": *Proceedings of the 11th International Conference of Faculty of Architecture Research Unit (FARU), University of Moratuwa, Sri Lanka, December 08, 2018* Galle pp. 377–386. ©

IMPACT OF OUTDOOR LEARNING LANDSCAPE ON PSYCHOMOTOR SKILL OF PRIMARY SCHOOL CHILDREN

Cases from Colombo, Sri Lanka

PERERA B.T.S¹ & HETTIARACHCHI.A A.²

Department of Architecture, University of Moratuwa, Moratuwa, Sri Lanka,

¹btsperera@gmail.com, ²anishkah@uom.lk

Abstract

Integration of landscape design elements in school environments to develop learning and skills of children is a research area of increasing interest. Development of psychomotor skills is established as vital in the overall growth of a child's brain, leading to a well-balanced adulthood. In view of this, the current study looks in to the impacts of incorporating landscape elements in outdoor learning spaces on psychomotor development of primary school students in the local context. The investigation adapted a mixed method consisting both qualitative and quantitative approaches. Critical case-study approach was used to select the schools where incorporation of landscaping elements in outdoor teaching-learning environments is critically low. Data was collected from grade 3 students of three primary boy's schools (n=10 per each school, age: 7-10) located in Colombo. Layout maps, behavioral maps and a photographic survey were used to study the factors of outdoor learning spaces while a set of pre-determined activities of movement assessment battery for children (Movement ABC assessment) was adopted to assess the level of psychomotor skills namely speed, precision, co-ordination, strength, endurance, agility and grace. The research findings affirmed that the presence of landscape elements in outdoor learning environments have significant impacts on the psychomotor skill development of primary school students. Higher the landscape elements established within school premises (Case 1-100%, Case 2- 75%, Case 3- 38%), scores higher in psychomotor scaling (Case 1- 69%, Case 2- 55%, Case 3- 51% respectively). This research recommends to incorporate the concept of learning landscape in order to accelerate the development of psychomotor skills among school children. The study suggests re-thinking of the approaches in designing contemporary landscapes associated with learning spaces in order to uplift the quality of outdoor learning to make well balanced scholars through the education system of Sri Lanka.

Keywords: *Learning Landscapes, Primary School Children, Psychomotor Skills, MABC Test*

1. Introduction

1.1. RESEARCH BACKGROUND

An effective designer uses his professional ability creatively and meaningfully to produce designs conducive for the growth and well-being of respective users. When designing for children, utmost care should be taken by the designer to assist the development of a child educationally, socially and psychologically throughout the childhood ensuring fully-fledged and well balanced adulthood. The environment in which a child is being brought up is found to have direct influence on his/her development and later outcomes in life. Children usually spend half of their day at school where they get a wide array of learning experiences that mould their future. As established through literature, the school environment should be designed in such a way that the development of a child's cognitive, affective and psychomotor domains (Bloom, 1956) are catered to.

1.2. NEED OF THE RESEARCH

Studies on nature have proven its benefits on childhood mentality (Gibson, 1979) and skill development. Due to rapid urbanization the school environment has become denser with less presence of nature decreasing opportunity for outdoor learning. Incorporating the notion of 'Biophilia'; the human's intrinsic need to affiliate with nature (Wilson 1984), the playgrounds and outdoor spaces of elementary schools in international context are now being renovated into innovative play and learning

spaces, identified as 'learning landscapes'. With the introduction of dynamic landscape designs, equipment and a range of activities, these designs help students learn through play. However, the notion of learning landscape has been rarely incorporated in to outdoor learning environment in Sri Lankan context.

1.3. RESEARCH PROBLEM

In view of this, the current investigation probes in to the importance of incorporating learning landscape design elements to positively affect a child's psychomotor skill development being the least studied domain of bloom's taxonomy (Micklich, 2011) with reference to local context.

1.4. OBJECTIVES

The study questions the factors in outdoor learning landscapes which affect the psychomotor development in primary school children. It is attempted initially to identify the established parameters which affect psychomotor skill development of children in the learning process. As the principal objective, the study focuses on identifying the landscape elements which has a conducive effect on psychomotor skill development in outdoor learning landscape environments.

1.5. SCOPE AND LIMITATIONS

This investigation was limited to the study of outdoor learning process in three selected boys' schools of Colombo District. The research was executed only during the school hours and limited to assess selected psychomotor skills and child's relationship with the environment. The sample was limited to 10 male primary school children from each class aged between 7-10 years. Sample selection was done considering equal physical attributes, socioeconomic and family background of primary school children in order to avoid other contributing factors which can have an impact on psychomotor skill development. The study was focused only on outdoor landscape elements and their impacts on psychomotor skill development of primary school children.

2. Literature review

2.1. PRIMARY SCHOOL CHILD

The age from 6 - 11 is the critical stage of a child's development where they become more appreciative of what's happening in the nearby surrounding. According to Piaget's theory of cognitive development, children at this age group are at the concrete-operational stage in which they understand through logical thinking and categories (Siegler et al., 2012). Children in middle childhood are characterized by physical, cognitive and psychosocial domains (Eccles, 1999).

2.2. PSYCHOMOTOR DEVELOPMENT OF A CHILD

Bloom's (1956) taxonomy identifies three learning domains namely; cognitive, affective and psychomotor. The cognitive domain includes skills associated with remembering, recalling knowledge, thinking, problem solving and creating (Bloom et al., 1956). Affective domain deals with development of emotions and values leading to whole-person learning while the development of psychomotor domain includes acquisition of behavioral skills and executive skills (Micklich, 2011). Psychomotor development is the relationship between cognitive functions and physical movement. The adequate acquisition of fundamental motor skills (FMS) during early childhood has been considered as a crucial step in developing specialized and more complex motor skills later in life". Kokštejn, Musálek and Tufano (2018). In psychomotor learning research, attention is given to the learning of coordinated activity involving the arms, hands, fingers, and feet, while verbal processes are not emphasized. Psychomotor development comes as a sensory-perceptual-motor foundation and is an essential contributor for education and psychomotor re-education processes. As it works directly on the organization of sensation, perceptions and cognitions, it can be focused on previously planned and scheduled adaptive responses (Prado et al., 2016).

2.3. PSYCHOMOTOR ASSESSMENT METHOD

For the evaluation of psychomotor development, there are several batteries and tests, namely; the Motor Development Scale (MDS) which assesses psychomotor areas according to chronological age (CA) of the child and movement assessment battery for children (MABC). Some studies assessed psychomotor development in different clinical and social situations such as school deficiency, learning

difficulties, physical activeness, gender, age, socioeconomic status, virtual reality and obesity (Prado et al., 2016).

2.3.1 Movement assessment battery for children- MABC

The movement assessment battery for children (MABC) (Henderson, Sugden, & Barnett, 2007) is a tool highly recommended for testing the psychomotor skills of children. The M-ABC is a product oriented, norm referenced test designed to identify children aged 4–12 years with motor difficulties, clinical exploration, intervention planning, program evaluation and research (Henderson & Sugden, 1992). The M-ABC Test consists of eight items grouped in three sections namely, manual dexterity, ball skills and balance. Item content is differentiated according to the examinee's age where older the child, the more difficult the item will be. Accordingly, four types of tasks are formed corresponding to the four age groups, which the test is designed for: age group 1 (4–6 years), age group 2 (7–8 years), age group 3 (9–10 years), and age group 4 (11–12 years). The test items for age group 7-10 considered for the current investigation are presented in Table 1. According to the test manual, each child is individually tested and the testing duration is 20–40 minutes (Henderson & Sugden, 1992).

Table 1: Items of the Movement ABC test for 7-10 age group.

Tests within the particular motor components
Fine motor coordination (manual dexterity)
Placing pegs (time – seconds; averaged over hands) Threading lace (time – seconds) Drawing trail (number of errors)
Gross motor coordination (aiming & catching)
Catching with two hands (number of catches) Throwing beanbag onto mat (number of hits)
Balance (static & dynamic)
One-board balance (time – seconds; averaged over legs) Walking heel-to-toe forwards (number of steps) Hopping on mats (number of jumps)

2.4. CHILDREN AND LEARNING LANDSCAPE

The use of landscape as a term in science is relatively new. Landscape today, refers to not only a phenomenon described and analysed by scientific methods, but also a subjective experience which has perspective, aesthetical, artistic and existential meaning (Memlük, 2012). Landscape design is the art and science of organizing and enriching outdoor spaces through the placement of plants and structures in agreeable and useful relationships with the natural environment (Zanden and Rodie, 2008 cited in Nebraska Master Gardener Handbook, 1994).

It is established that learning landscape directly or indirectly assists in the learning process of a child, providing space for leisure, interacting with landscape components, as well as outdoor lessons and revisions which in turn produces a balanced personality. Learning landscape is being applied in various countries in order to gain a positive outcome of pupils. Studies show that landscape is open-ended and intrinsic. As a matter of fact, it can speak to the physical, emotional, social, and intellectual growth of a developing child (Herrington, 1997, p. 151). There are findings that this has been done on collaboration with a child's psychology and landscape Architecture to construct which self-skills. A study done by Herath and Hettiarachchi (2018) affirmed that learning landscape has a direct impact on the growth and development of cognitive skills of pre-school children. A natural learning environment supports each child's construction of his own knowledge of the world and his place in it (Stone, 1995, p. 104). A child's primary education directly influences the future of the child. Thus, during such a scenario, the location and the learning environment become a great influence. They give much attention on physical, social, cognitive and emotional growth of the child. Tones (1997) has arrived at four assumptions regarding the learning landscape.

1. Children learn through play and play is necessary for the child's development and growth.
2. Play is not limited to younger children, it is an important concept in adults' life- cycle.

3. To play outside is an important need because it offers opportunities not found anywhere else.
4. Play environments are educational areas

Campbell (2013) has identified six key components of learning landscape which facilitate a wide range of actions and reactions from children namely; active space, gathering space, experimental space, individual spaces and ecological space. Outdoor class rooms and gathering areas have found to improve children's recognition, problem solving, cooperation, communication and socialization.

3. Theoretical Framework

Theoretical framework forms the basis for the research design and analysis to assess the impact of landscape elements on psychomotor skill development in primary school children. Theoretical framework was derived from the established theories and the findings from scholarly research done on the connotation between outdoor learning landscape and skill development of primary children.

Table 2: Five key components of learning landscape - Campbell (2013)

Theme spaces	Associated skill development	Design components/areas
1. Individual	Self-discipline Creativity	Natural elements
2. Experimental	Questioning, Curiosity Observation, Empathy Creativity, Expression	Water wall, sound wall, exploration areas, rainwater harvesting system, habitat gardens,
3. Ecological	Nature, experience Perceptual Recognition Problem solving	Edible places, plant information box, thematic garden seasonal garden, wooded areas,
4. Active	Fine and gross motor Fitness Reduce stresses Balance Self-confidence	Dramatic Balancing and climbing logs, climbing wall, different topographical surfaces areas, running paths, adventure trail, maps and paths, cycling road, activity wall
5. Gathering	Cooperation and sharing Communication skills Socialization Problem Solving Sense of self experience	Dramatic play area, activity areas, mounds and hills, outdoor classroom, planting areas, nature trips camp grounds

The research being run totally based on local context, caused limitations in the landscape elements present, outdoor learning activities provided, time frame in hand and the research scope. For instance, some of the activities suggested by Campbell (2013) was found as unrealistic in the local context, thus neglected. It was attempted to extract suggested theme spaces which can be adapted to the local situation by examining the landscape elements present in the selected cases. Based on the Blooms taxonomy which defines the psychomotor skills to be developed, it was attempted to test selected motor skills which can be locally assessed namely; strength, endurance, coordination, precision, dexterity and grace. In deriving the theoretical framework, psychomotor skills related with the child activities were extracted from the MABC model.

Below table 3 shows the relationship with the selected activities from MABC, psychomotor skills derived from the blooms taxonomy and the landscape elements related with the motor skills which were filtered from the research done by chambell (2013).

Table 3 Derived theoretical framework from the literature

Activities - MABC	Measurement	Landscape element
Activity-1 Catching ball	Speed Precision Coordination	Clear distance, Topographical changes, Variety of materials, Scale
Activity-2 Throwing bean bag on to mat	Precision Coordination	Soft and hard landscape,

Activity-3 On board balance	Strength Endurance	Climbing wall, Topographical changes, Dramatic garden
Activity-4 Walking heel to toe forward	Speed Agility Grace	Clear distance, Topographical changes, Presence of a variety of materials, Scale, Tree log, Rock boulders

4. Research Methodology and Data Collection

Adopting a critical case-study approach, three local cases were selected where incorporation of landscape elements in outdoor teaching-learning environment is critically low. The case studies selected were from Colombo, representing a tight urban context characterized by relatively poor outdoor spaces, quality of landscape and similarity in cultural and educational backgrounds of the students. Primary children selected for the research were in ages 7-10 and with equal physical and socioeconomic attributes (10 boys from each school) namely; height, weight, health conditions, economic and family background. Psychomotor skills of primary children were assessed based on movement assessment battery for children (MABC) incorporating tests designed for 7-10 age group (Henderson & Sugden, 1992). Since research was based on landscape related activities, the tests adopted were limited to landscape related situations. The students were instructed to perform the given tasks as elaborated below and their performance was assessed through MABC.

Activity one - Catching ball: 5 attempts were given for each student to throw a ball towards a wall with the distance of 1.8m and their ability to catch the ball with or without any bounce was observed.

Activity two - Throwing bean bag on mat: Each child was given 10 attempts to throw a bean bag on a mat with the distance of 1.8m and their ability to aim at the target was observed.

Activity three - One Board Balance: Children were given 30 seconds to stand on one leg. Both legs were observed to check their psychomotor skills.

Activity four- Walking heel to toe forward: Each child was asked to walk on a line and their walking speed and associated psychomotor skills were tested.



Fig1: Activities were executed in order to discuss different psychomotor skills

4.1. CASE STUDY ONE

Children of this school are normally taken outside the classroom for co-curricular activities. As they were allowed to play with soil, plants and water, they automatically have built up close contacts with nature. They were allowed to perform a range of activities within and away from the classroom. The school comprises with spaces which are surrounded by trees and valleys which provide spaces for them to play. A large playground is located within the play area. Moreover, a colourful play area could be observed nearby. Accordingly, the children are given opportunity to play alone and in groups. They have made the surrounding a child friendly environment.



Figure 2: layout map with landscape elements-case study 1

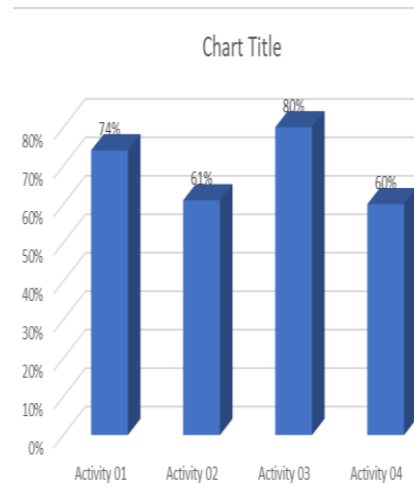

Figure 3: success rate of each activity-case study 1

As shown in layout plan (figure 2) buildings and landscape elements are well planned and organized. Different types of landscape elements such as sand, woods, seating and gathering places, walls with paintings, dramatic play area, habitat gardens, different topographical surfaces, running paths and large active play areas can be observed in outdoor environment. Compared to other case studies the school has well organized large outdoor spaces for primary children and the children are given opportunity to build up a strong connection with the outdoor environment. Except gathering and seating areas, all the outdoor play areas are open to the clear sky while the shading is provided when and where necessary. Outdoor learning environment is visually and physically well linked with the indoor learning environment without any separation. Use of both soft and hard landscaping was observed in case study one.

According to the data (figure 3) students of case study one show the highest success rate percentage for the activity three - one board balance (80%). This finding signifies that the psychomotor skills such as strength and endurance of selected group of students is higher compared to other skills. They were found to have the lowest average for the fourth activity- walking heel to toe forward (60%) indicating low levels in the skill development related to speed, coordination and agility.

4.2. CASE STUDY TWO

Student's connection with the outdoor landscape elements were found as relatively less in case two. School buildings are scattered all over the land. Students are allowed to perform activities within and away from the classroom. This school comprises with spaces which are surrounded by trees, and valleys which provide spaces for them to play. A play area has been formed in order for the students to run around. However the provided area is comparatively small. Some shady trees can be found around this area providing opportunity for the children to play alone and in groups. They have made the surrounding a child friendly environment to some extent.

As shown in layout plan (figure 4) buildings and landscape elements are scattered in land. Less variation of landscape elements in outdoor environment can be observed compared to case -1. Natural elements such as woods, seating and gathering places, dramatic play areas, habitat gardens, different topographical surfaces, running paths, edible spaces and active play areas were observed. Compared to case study- 1, the scale of the outdoor spaces for the primary children are less. But with this limited and scattered spaces, children have built up connection with outdoor environment to some extent. Most of the outdoor play areas are shaded, having a rich vegetation layer. Some Outdoor spaces are found to be separated from the indoor learning environment; e.g. dramatic play area. The outdoor environment has utilized hard landscaping mostly while soft landscape has been incorporated only to some extent.



Figure 4: layout map with landscape elements-case study 2

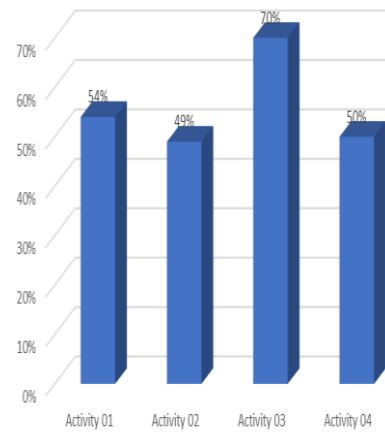

Figure 5: success rate of each activity-case study 2

In case study two, students demonstrated a highest success rate percentage for activity three - one board balance (70%) signifying high development levels in strength and endurance over other skills. Lowest average was observed for the second activity - throwing bean bag (49%) indicating less development in coordination and precision.

4.3. CASE STUDY THREE

Very less variety of landscape elements and lack of organized outdoor spaces were observed in case study three. Accordingly, the student's connection with the outdoor landscape elements is less. Though the school has rich open spaces, those are unorganized. School buildings are scattered all over the land. Within this circumstances, the students have not been able to build up strong connections with the nature to a greater extent. The teachers were found to focus mostly on indoor learning rather than outdoor activities. This school comprises of spaces which are surrounded by trees, and valleys which provide small spaces for the children to play. A play area and a running pathway has been formed for the students to run around in a clear area which is relatively large. Some shady trees can be found around this area where the children are given the opportunity to play alone and in groups to some extent. The school has mostly utilized hard landscaping for outdoor.

Landscape elements incorporated are not well planned and organized. On the other hand, the range of landscape elements incorporated in the outdoor environment is less. Only seating and gathering places, running paths and active play areas were observed in Case - 3. Though case- 3 has large outdoor spaces compared to other two case studies, they are not organized for the children's activities and their exposure to the outdoor environment is poor. Except gathering and seating areas outdoor play areas are open to the clear sky. A small area has been provided for the primary children and for their outdoor activities. Compared to the other schools, this school has the longest running pathway. Outdoor learning environment is visually and physically linked with the indoor learning environment but encouragement was not there from the landscape design.



Figure 6: layout map with landscape elements-case

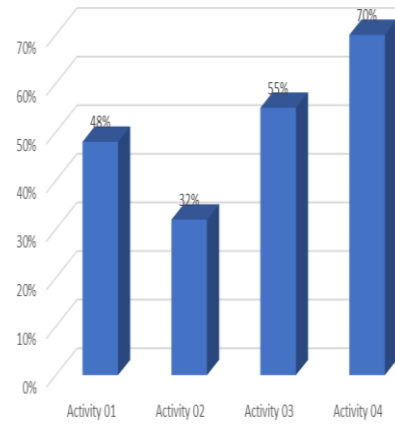

Figure 7: success rate of each activity-case study 3

Case-3 showed (figure 7) the highest success rate percentage for the fourth activity- walking heel to toe forward (70%) indicating high levels of children’s coordination, speed and agility compared to other psychomotor skills. They got lowest average for the second activity (32%) which was throwing the bean bag. It was observed that coordination and precision skills showed a poor development for this sample.

5. Analysis and Results

Table 4: Available Landscape element in case studies

Case study	Elements							
	E1	E2	E3	E4	E5	E6	E7	E8
01	Available	Available	Available	Available	Available	Available	Available	Available
02	Available	Available	Available	Available	Not available	Available	Available	Not available
03	Not available	Available	Available	Available	Not available	Not available	Not available	Not available

Available Not available

List of landscape elements

E 01	Dramatic play area
E 02	Active space
E 03	Gathering/seating space
E 04	Running path
E 05	Natural elements
E 06	Different topographical surfaces
E 07	habitat garden
E 08	Edible spaces

Table 5: Average scores for all activities and availability of landscape elements.

Case study	Landscape Elements								AVG. score for all activities	Availability of landscape elements tested
	E 1	E 2	E 3	E 4	E 5	E 6	E 7	E 8		
Case study 01	Available	Available	Available	Available	Available	Available	Available	Available	69%	100%
Case study 02	Available	Available	Available	Available	Not available	Available	Available	Not available	55%	75%
Case study 03	Not available	Available	Available	Available	Not available	Not available	Not available	Not available	51%	38%

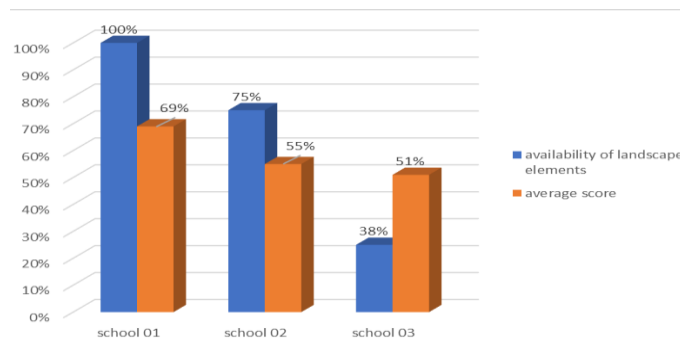

Figure 5: Final average scores and the availability of landscape elements

The research findings have been summarized in to final average scores for MABC tests conducted in comparison with the availability of landscape elements represented in percentages (figure 5). Case study one represented the highest variety in terms of the landscape elements and the extent of outdoor learning environment provided (100%). Validating the line of thinking, the results of case-1 demonstrated the overall highest average scores for three of the MABC tests. Similarly, case - 2 having the 2nd highest availability of outdoor landscape elements (75%) displayed 2nd highest MABC average score. Average test score was found to be the lowest in Case - 3 which was reported to have the least availability of landscape elements (38%). Average scores for all the MABC tests per each case has been further analyzed as follows (table 6).

Table 6: Average scores of MABC tests in case studies

	Activity 1	Activity 2	Activity 3	Activity 4	Average
Case study 1	74%	61%	80%	60%	69%
Case study 2	54%	49%	70%	50%	55%
Case study 3	48%	32%	55%	70%	51%

As per the findings (table 6) case study 01 demonstrates the highest average score for every activity, except activity 4; walking heel to toe forward. Case study 03 obtained the highest score for activity 4 supposedly due to the presence of clear long running pathways rather than the other two cases. Accordingly, it was revealed that clear and large outdoor spaces are supportive in developing speed, agility and grace. Re-affirming Campbell’s (2013) thinking, case studies having quality landscape elements have scored well in MABC tests. Accordingly, the study revealed a clear relationship between the level of exposure to landscape elements in the outdoor learning environment and the level of psychomotor skill development of primary school children

6. Conclusions and recommendations

As depicted by the findings, it can be clearly identified that case -1 has surpassed the other two cases having a variety of landscape elements within the premises leading to the highest average for psychomotor skills of children. The relationship was found to be slimier with reference to case -2 and case -3 which demonstrated a decrease in the development of psychomotor skills parallel with the lessening of the availability of landscape elements in terms of their availability, variety and usability in outdoor learning environment. Accordingly, the findings of the study establishes that there is an impact of outdoor learning spaces on children’s psychomotor skill development process.

It was further aimed on searching factors/elements of learning landscape having a contribution on primary school student’s psychomotor skills development focusing on the six key components identified by Campbell (2013) as a basis. The study confirmed five key spaces of learning landscape as conducive for primary learning namely; active spaces, gathering spaces, individual spaces, ecological

spaces and experimental spaces. The research affirmed that above five spaces help to develop the psychomotor skills such as speed, precision, coordination, strength, endurance, agility and grace. Concern about outdoor learning experiences in the education system is relatively low in local context compared to other parts of the world. As per the guidelines set by Chambells (2013), even an outdoor learning environment located in a tight urban context can be improved using landscape interventions to nurture child development. It is suggested to introduce natural elements like rocks, sand, plants to improve children's creativity and self-discipline. The method of developing psychomotor skills of primary school children through learning landscapes is rarely used in the Sri Lankan context. Thus, this research provides insights for Architects, Landscape Architects and designers to take the above mentioned factors into keen consideration when creating learning landscape spaces conducive for skill development of children.

With the limited time and resources this particular research was based on a small sample (n=10) of male children of primary schools who are in 7-10 age group. By adopting MABC, this research can be further developed to test the other age bands supposedly, 4-6, 7-8, 9-10, 11-12 with large samples. It is suggestive to conduct the study with female samples to test any difference in the levels of skill development. The study recommends to incorporate larger capacity in landscaped areas, diversity in landscape elements and its organization aligned with the curriculum and outcomes of primary learning as a strategy in developing psychomotor skills in Preschool children within local context.

7. Bibliography

- Acar, H. (2013). Landscape Design for Children and Their Environments in Urban Context. <https://doi.org/10.5772/55751>
- Bloom, B. (1956). Taxonomy of educational objectives. New York, 1. Retrieved from [https://scholar.google.com/scholar?hl=en&as_sdt=0,5&q=Benjamin+bloom+\(1956\)+bloom%27s+taxonomy](https://scholar.google.com/scholar?hl=en&as_sdt=0,5&q=Benjamin+bloom+(1956)+bloom%27s+taxonomy)
- Bloom, B., et al. (1956). Taxonomy of Educational Objective: The Classification of Educational Goals: Handbook 1: Cognitive Domain, David McKay Company, Inc.
- Campbell, H. (2013). Landscape and child development. Evergreen. Retrieved from https://scholar.google.com/scholar?hl=en&as_sdt=0%2C5&q=Campbell%2C+H.+%282013%29.+%3Alandscape+and+child+development.+Evergreen.&btnG=
- Eccles, J. (1999). The Development of Children Ages 6 to 14. Princeton University, Vol. 9(No. 2), 30–44. <https://doi.org/10.2307/1602703>
- Gibson, J. J. (1979). The Ecological Approach to Visual Perception. Boston: Houghton-Mifflin.
- Henderson, S., Sugden, D., Barnett, A., & Schulz, J. (2011). Structural validity of the Movement ABC-2 test: Factor structure comparisons across three age groups. Department of Psychology, University of Hertfordshire, UK, 32(4), 1361–1369.
- Herath, H.M.H. and Hettiarachchi, A.A. (2018). Impact of learning landscapes in developing cognitive of preschool students; cases from Kandy, Sri Lanka, IFLA World Congress Singapore 2018 - Biophilic Cities [e-Proceedings - Featured Speakers & Paper Presentations], p.p 57-69, Retrieved from <http://www.ifla2018.com/eproceedings>.
- Herrington, S & Lesmeister, C. (2007). The design of landscapes at child-care centres: Seven Cs. 2006, 31, 63–02.
- Keith, T. (1997). HEALTH EDUCATION RESEARCH. Oxford University, 12(2), 161.
- Kokštejn, J., Musálek, M and Tufano, J.J. (2018). Construct Validity of the Movement Assessment Battery for Children-Second Edition Test in Preschool Children with Respect to Age and Gender, Front Pediatr.; 6: 12. Memlük, M. (2012). Urban Landscape Design. Ankara University.
- Micklich, D.L. (2011). Examining the cognitive, affective, and psychomotor dimensions in management skill development through experiential learning: developing a framework Developments in Business Simulation and Experiential Learning, volume 38, P.P: 261 -272.
- Prado, M. T. A., et al. (2016). Analysis of psychomotor development and level of physical activity of children with extracurricular physical activities. Acta Fisiátrica, 23(4). <https://doi.org/10.5935/0104-7795.20160039>
- Siegler, R. (Ed.). (2013). Fractions: the new frontier for theories of numerical development. Department of Psychology. Retrieved from <http://www.psy.cmu.edu/~siegler/Siegler-et-al-2013.pdf>
- Stone, S. (1995). Childhood Education, 72(2). Retrieved from <https://www.tandfonline.com/doi/abs/10.1080/00094056.1996.10521856?journalCode=uced20>
- Wilson, E.O. (1984). Biophilia. Harvard University Press; Cambridge, MA, USA.

Samarawickrama, Sumanthri, et al (eds), 2018, "Sustainability for people - envisaging multi disciplinary solution": *Proceedings of the 11th International Conference of Faculty of Architecture Research Unit (FARU), University of Moratuwa, Sri Lanka, December 08, 2018* Galle pp. 387–393. ©

FROM HORIZONTAL TO VERTICAL: HABITUS TRANSFORMATION IN RESETTLEMENT OF UNDERSERVED COMMUNITIES TO HIGH RISE BUILDINGS

RANDIMA DE SILVA¹ & PRASAD BOTEJUE²

Department of Architecture, University of Moratuwa, Sri Lanka

¹randima.ds92@gmail.com, ²pbotejue@hotmail.com

Abstract

Housing... amongst the many discussions of architecture and sociology, there isn't a topic more timely and relevant. A main concern in the discussion, the urban poor living in long established underserved settlements, grow and spread by the day. To provide better living conditions and claim valuable real estate, many governments including Sri Lanka commonly adopt resettling the people to high-rise social housing. The success of this solution however is still debated upon. The process of resettlement involves changing the environment of the people from horizontally spread neighborhoods to the vertical towers. Social implications of the process could be observed in many precedents, yet the understanding about the transformation is limited. The study intends to critically look in to the social life of resettlers and see how the transformation happens. The broad concept of social life is narrowed down and analyzed through the concept of "habitus" and related theories. Mihidusenpura social housing in city of Colombo was selected as the case study to explore the transformation over 10 years. The study explores how each aspect is affected with time, what needs to be preserved and in conclusion how habitus can be manipulated using architecture and proper planning to create successful social housing.

Keywords: *home, neighborhood, housing, low income, habitus, transformation*

1. Introduction

Houses are a physical entity as well as a social and a psychological entity. It touches every human being in profound ways. (Adams, 1982). It is interesting to see how "low income" or "urban poor" is identified by the living conditions of the people, with housing as the benchmark. It is observed that the urban poor who exceed the minimum per annum income per family (US \$1,345 per annum) that benchmark the poverty in Sri Lanka (Department of Census and Statistics, 2011; Melbourne Institute of Applied Economic and Social Research, 2012). live in squalid conditions in low income settlements, otherwise known as slums.

Slums-watta in Sinhalese—occupy the central, northern and northeastern parts of Colombo. According to Sevanatha (Sevanatha) Slums in the inner city areas are the oldest low-income housing in Colombo. *The Watta Dwellers* (Silva & Athukorala, 1991) This identification with particular *wattas* remained strong amongst communities involved in this research. Strong community ties are evident amongst the watta residents and these results in forms of social control. The resettlement causes loss of these structures and strong ties. Residents in fact, do not want to leave their people behind and move. Especially the reports of Forced evictions show how people are traumatized and lose all the social, cultural and economic values because of being evicted and resettled. (Perera, Ganeshathasan, Samaraarachchi, & Ruwanpathirana, 2014)

In Colombo, government implements Land exchange and land sharing method and relocation method and provide multistory housing to slum dwellers in order to free up land. *Samaratunga, T. C. (2013)* The guidelines provided for the government agencies show that much attention need to be given in relocating (A guide on planning of condominium property and management, 2007), yet the process takes place only using physical and legal attributes such as voting rights, availability of an address etc.

The paper sheds light to the transformation of the social setting that takes place once a community is resettled and how this knowledge can be used to make resettlement of urban poor smoother and a

successful process. Subsequently architectural solutions are suggested to the identified situations.1.1 Objectives

- To study about the social values and relationships in underserved communities with the architectural setting.
- To study the social transformation after the relocation in to a high riser social housing.
- To understand what elements contribute to betterment of the social life and what has receded with negative impacts
- To compare and contrast the two situations and arrive in to conclusions about how to go beyond where we are today in social housing, in making policies and in architectural approach.

2. Theoretical framework

Social setting is a highly vague and a broad term. To define and quantify a society’s change and its transformation, the concept of Habitus by Pierre Bourdieu is used.

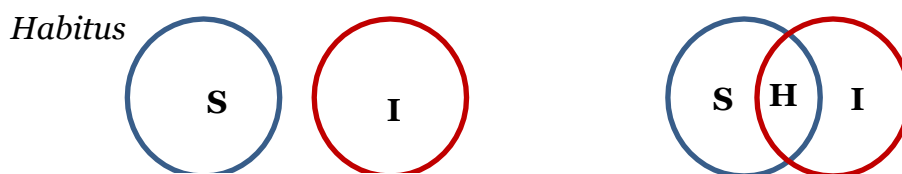

Figure 1 Habitus, agency and structure (Mallikaarachchi, 2003)

This figure shows that habitus is a common point between social structures and agent. Structures like rules, norms, regulations and the individual together create the way one would perceive the world. The importance of this concept is that it is described by Bourdieu as a genetic structure. It has a power of genesis and generation. (Bourdieu & Wacquant, 1992: 135) habitus could be thought of “as a sort of spring that needs a trigger and depending upon the stimuli and structure of the field [social setting], the very same habitus will generated different, even opposite, outcomes.” The research makes use of this generating power to see how habitus of the relocated people change after they have been moved.

2.1 RELATED THEORIES

Habitus is difficult to be discussed without discussing the theories that relate to it. The other two, much discussed theories put forward by Bourdieu are fields and forms of capital.

Fields are where people fight for social recognition and position, and habitus is what makes them use the right weapon in the right manner to win or just survive. The forms of capital are the weapons, or currency he uses to gain position and power in this field. Bourdieu (1997). (Grootaert, 2004.)

Table 1 Theory vs variables assessed in the cases

Theory	Variables
Fields Arenas where agents engage	Religion, Language. Occupation, Gender, Local Organizations
Social Capital	
Bonding Social Capital strong relationships/ bonds with a group of people, homogeneous in socio financial position and demographic characteristics.	Level of trust, communication, Number of interactions per day, Respect and acceptance of neighbors

<p>Bridging Social Capital Refers to social networks amongst people of heterogeneous social groups.</p>	<ul style="list-style-type: none"> • Level of trust, interdependence on neighbors • Inclusion of different religious groups in celebrations
<p>Linking Social Capital this capital spans in the vertical dimension. represents the linking social ties between groups and people in positions of authority and influence. (Grootaert, 2004.)</p>	<ul style="list-style-type: none"> • Relationships with people of power • Relationships with the people who has higher economic, social and cultural capital
<p>Objectified cultural capital Symbolically and materially active, objectified cultural capital often presents it self as ownership of physical goods culturally valued.</p>	<ul style="list-style-type: none"> • Vehicles owned • Nature of furniture Level of decoration of the houses
<p>Economic capital A person's revenues and possessions that can be liquidated are included in economic capital. This can be converted in to other forms of capital easily, while it's not that easy to do vice versa.</p>	<ul style="list-style-type: none"> • Level of income Other means of income

HYPOTHESIS

- In underserved settlements the physical, social and cultural factors drive the people to create a social habitus towards their home and immediate environment
- The people resettled in high risers, the new physical, social and cultural factors drive the people to create a personal habitus towards their home and immediate environment.

3. Methodology

The research needed an extensive study of literature to build up a strong theoretical framework in order to quantify social change with use of existing literature on the field and research. The research was Identified, analyzed and presented as a transformation process.

1. The site for the selection of cases needed to be an area where the initial settlement of the relocated people or a part of it is intact., where
 - Since the study focuses on the process of transformation, the ability to observe the original habitus is needed. Therefore
 - The settlement needs to have people who are still in the process of adjusting to their new environment.
 - The settlement needs to have people who have adjusted to the new situation, yet remember their previous settlement.
 - The settlement needs to be of 5 stories or above, because the impacts of moving from a horizontal community/ settlement to a vertical structure need to be observed.
After setting the case selection criteria two housing blocks in Mihidusenpura housing scheme were selected where samples of people who have been living for 3 years and 10 years respectively in high rise social houses could be seen.
2. A pilot study was undertaken with the involvement of 30 families with a brief questionnaire. 8 Families were selected to study in detail, 4 resettled only for 3 years and 4 resettled for 10 years.
3. Onsite observations and interviews done with the insight gained from Pierre Bourdieu's study done in the "distinction" Analyzed with coding of interviews and behavioral analysis
4. Analyzed and presented according to parameters of theory of field, forms of capital and habitus. (Lewin, 1951) (Bordieu, Distinction ; A social critique of judgement of taste, 1984) (Robson &

Sanders, 2009)

The following components were identified for the field study.

Component 01

- Observing the social behavior of people who had been resettled for 3 years and 10 years.
- Identifying the habitus and level of change by inquiring about
 - Social fields
 - Cultural capital
 - Economic capital and
 - Social capital
- Identifying the response of the residents towards the change in their built environment.

Analyzing and presenting the transformation of habitus of the residents from horizontal to vertical with the aspects using the criteria extracted from literature

Component 02

- Identifying the behavioral patterns of people in their built environment that provides an explanation to the nature of their habitus
 - Studying the impact on the change of architecture from horizontal to vertical.

4. Findings

4.1 SOCIAL IMPACTS OF RELOCATION

The derived graph identifies the first 3-4 years since resettlement as a period of “initial shock”. It is observed that during the first few years, people rent out the houses they get from the government and move back to the slums. People are traumatized from their homes being taken away and losing their community. The people become lonely in their houses, showing masks of politeness and keeping distance, making them unhappy about the new “home”. The habitus they possessed is left useless in this new setting and they have to find ways to survive anew. Especially the transformation of the habitus leave them disoriented.

If people are made to remain in the housing for this period, create a satisfaction in the first few years, by the time of ten years they would develop habitus that would help them define and engage in the new environment in new ways

It is seen that the Bonding social capital shows a drastic change. For the people of this income group bonding social capital or social support is a currency that can be invested in gaining social leverage and earning other forms of capital. Help is needed always to get by and cope.

The Bridging social capital is on the rise showing their new relationships created amongst neighbors to survive in the society. The linking social capital has a trend of a slight drop followed by increasing, showing that since moving, the people have created relationships from out of their social strata indicating upward social mobility

They have a sense of belonging to the place, depicted by the increase in Cultural capital. They have accumulated cultural goods later in to resettlement, and has redecorated their houses to show their social status. These are signs of the newly developed sense of belonging to the place. Fields the people engage in reduce once they move, but recovers. Privacy increases just as they move, and then decreases. But does not reach the level it was when they were at the previous settlement. This shows their extroverted habitus in slums transforming in to an introverted habitus.

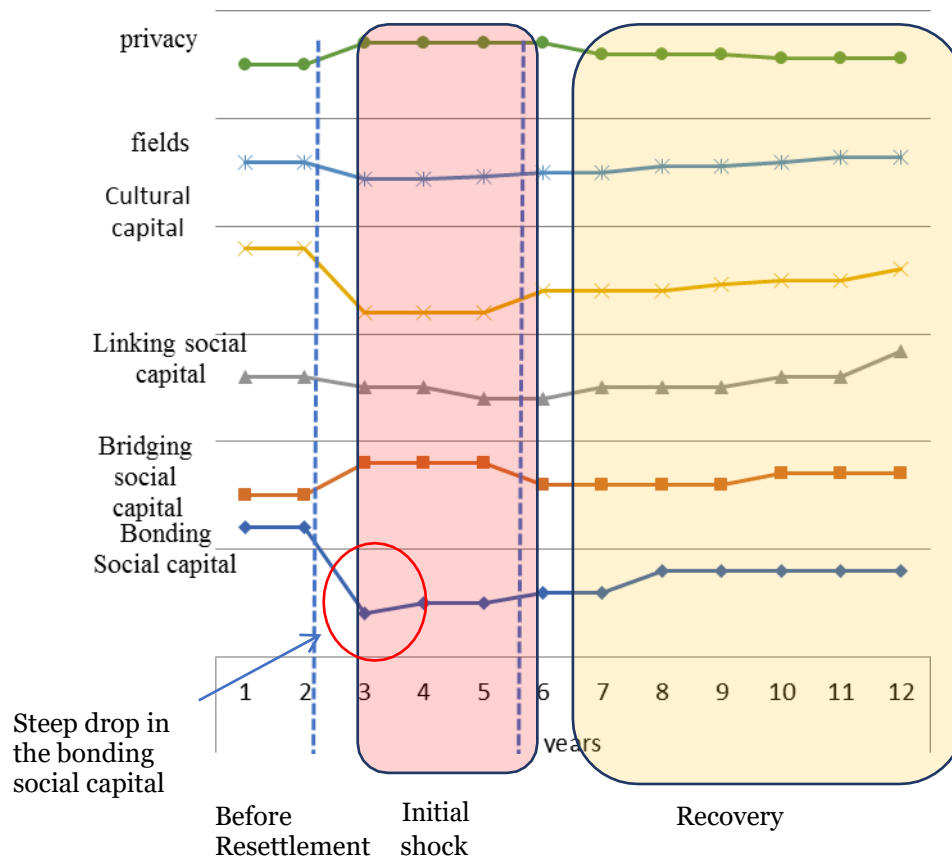

Figure 2 time series graph for transformation (Source: Author)

Habitus is a generative and an adoptive concept. **In long term** people have generated and adapted their habitus to maneuver through the new society without conflict. Here The lack of bonding social capital makes a huge difference. The architectural layout, dispersing the people, lack of informal gathering spaces, separating with linear monotonous series of houses, the vertical separation from each other and the linear corridors that do not urge a man to pause on his way to acknowledge a fellow man are some of the reasons why the bonding can be never restored in theses housing schemes. The society here is fragile, not as strong as in the slums they lived in. Therefore interference in the architectural design and the process need to be to ensure long term satisfaction. Creating spaces that are not rigid allowing them to relate it to their previous environment, creating spaces for informal gathering could ensure better relationships with their fellows. The resettlement needs to be done so that at least few people from the same community would be living in close together. Methods of clustering inside a housing block need to be explored to create smaller unique neighborhoods within the housing. The above suggested changes would ensure longevity in the housing, the former habitus would not have to be destroyed and rebuilt differently.

SUCCESS OF SOCIAL HOUSING

This research proves Social housing, in this case cannot be called a complete failure. People who came from row houses are appreciative of the facilities provided. The new habitus developed helps them engage with the outside world in a positive manner. However better attention should be directed to prevent social degradation. A tutor being turned in to a grocery vendor is a serious disadvantage for the community as well

People also feel threatened by the new communities resettled to the scheme. Their habitus in the previous settlement has made them to be weary of the outsiders and they still are. It drives people to abandon the vertical house for a horizontal house. People who possesses a low economic Capital cannot afford to dream of moving in to a horizontal settlement Therefore It is needed to ensure that the resettled people are given a sense of permanence, instead of constant change. The slow passive growth is suggested rather than the fast paced renewing of the neighborhoods that is already difficult to grasp

In the larger picture amassing all the poor in the city and putting them in segregated corners of the city causes serious social segregation and social stigma. Mihidusenpura itself has six blocks and more coming up. The residents expect to move away from this stigma and be recognized in a better manner. As suggested by Briggs in his article brown kids in white suburbs, an ideal solution would be to make small clusters scattered in a city, not building a socially segregated colony.

5. Conclusion

The research established the following two arguments.

- The communities resettled in these housing come from long established passively grown horizontal settlements. The communities are strengthened by the social bonds they share with each other, the supporting/bonding social capital they possess. The unit relocated in the process, “home” is a social habitus to them. The neighborhood and home doesn’t have separated margins.
- Once relocated, this habitus turns in to a personal habitus. The whole social setting is subject to change. Architects and policy makers need to ensure a smooth transition between the two environments. The research proves that by making the initial 4-5 years a success, the resettlement can achieve long term satisfaction of the people. Effort need to be put in to preserving the habitus of home as a social habitus and keep the bonding capital from completely getting destroyed.

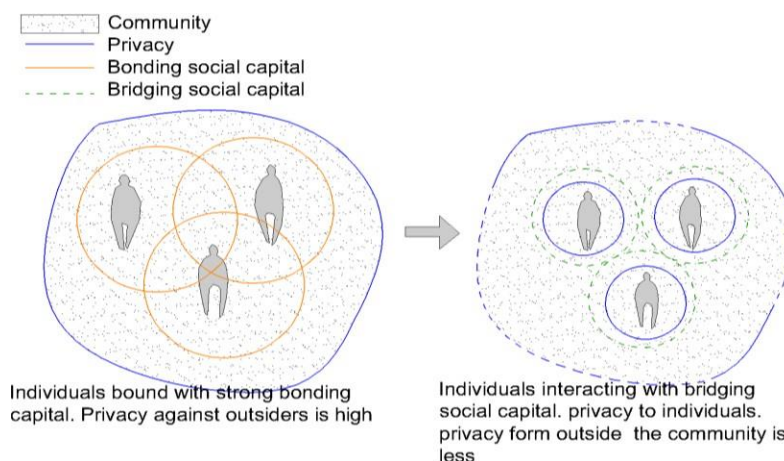

Figure 2 nature of the society before and after resettlement (Source: Author)

In exploring the variables related with habitus, It was seen that the **Bonding social capital is the main contributor towards a social habitus in home**. One may ask is it important to bring back the same quality to the improved housing. The answer would be a yes because this longing for a home where their social ties prevail, is never lost. It was seen that the people aspirations for the future doesn’t involve living in this housing scheme. They expect to move to a horizontal setup, and hidden in this is the desire to recreate their old social background

To create bonding social capital would be a long-term process. It is created amongst people who are well associated with each other. Architectural interventions that would increase common activities are one solution that would bring results in long term. Relocating people of the same community together, adopting better methods than drawing lotteries to determine houses(which is utilized presently) could be a starting step.

Once people move they increase their *privacy* and create new supportive relationships, *Bridging social capital*. These two aspects act as a cushion to huge social change faced by these individuals and are used as means to ease up the transformation. Therefore it is important to maximize communal spaces in the housing scheme to improve interaction increasing bridging social capital and eventually act as bonding social capital generators.

Another implementation of these results is that when removing neighborhoods known for violence and

misdemeanor the dispersing the neighborhoods will render their crime prone habitus inactive and they will have to develop a new habitus to claim position, power and acceptance in the new neighborhood. However the cases studied here do not include such excessively violent communities and more research needs to be conducted on the matter.

Allowing people to amass cultural capital architecturally, allowing them to make adjustments to the physical surroundings proved to be important. The time series analysis proves that the cultural capital is on the rise after they have overcome the initial shock. Facilitating the increase will help make the initial shock period shorter.

Creating opportunities to engage in the community and providing opportunities to improve income are factors that can be used to keep people more interacted in the housing. The research proves that the economic capital has rarely increased because of moving, and those who has improved engage in self-employment run at home.

Social housing is a process of relocating a “home”. The social habitus that once defined their home is distorted in to a personal habitus in the process of relocation. The loss of bonding social capital, which once created a strong community, is a result of the transformation of the habitus. It is vital to pay special attention to rectify the distortions faced in the first few years, and ensure the habitus with reference to their homes is not completely altered. It is needed to ensure a smooth transition between the two environments. To create successful social housing, achieving mere functional efficiency will not be enough. The research proves that by making the initial 4-5 years a success the resettlement can achieve long term satisfaction of the people. Changes done in the architectural and program aspects of housing can create better housing with long term satisfaction of the residents.

6. References

- A guide on planning of condominium property and management.* (2007). Colombo 02: National housing development authority; Condominium management authority;Tsunami housing support project.
- Adams, J. (1982). *Housing America in the 1980s*. New York: Library of Congress Catalogue Publication.
- Bourdieu, P. (1984). *Distinction ; A social critique of judgement of taste.* (R. Nice, Trans.) Oxon: Routedledge Classics.
- Grootaert, C. (2004.). *Measuring Social Capital; an integrated questionnaire.* Washington D.C: World Bank Publications.
- Lewin, K. (1951). *Field theory in social science: selected theoretical papers.* Harper.
- Mallikaarachchi, D. (2003). *Samaja ha manawa vidyathmaka rachana.* kuliyapitiya.
- Perera, I., Ganeshathasan, L., Samaraarachchi, S., & Ruwanpathirana, T. (2014). *Forced evictions in Colombo; the ugly price of beautification.* Colombo: CENTRE FOR POLICY ALTERNATIVES.
- Robson, K., & Sanders, C. (Eds.). (2009). *Quantifying Theory: Pierre Bourdieu.* Berlin: Springer Science+ Business.
- Sevanatha. (n.d.). *A case of colombo.* Rajagiriya: Sevanatha. Silva, K. T., & Athukorala, K. (1991). *The Watta-Dwellers: A Sociological Study of Selected Urban Low-Income Communities in Sri Lanka.* Michigan: University Press of America.

Samarawickrama, Sumanthri, et al (eds), 2018, "Sustainability for people - envisaging multi disciplinary solution": *Proceedings of the 11th International Conference of Faculty of Architecture Research Unit (FARU), University of Moratuwa, Sri Lanka, December 08, 2018* Galle pp. 394–401. ©

GREEN BIM FOR EXISTING BUILDINGS

PAVITHRA RATHNASIRI¹ & SURANGA JAYASENA²

Department of Building Economics, University of Moratuwa, Sri Lanka

¹stprathnasiri@gmail.com, ²suranga.net@gmail.com

Abstract

There was a flourishing interest and cognizance on green building constructions in past few decades due to considerable negative impacts for the environment from traditional construction processes. In light of this, number of modern technologies have been invented to enhance the performances of sustainable and green strategies. Green Building Information Modeling (BIM) is one of such modern advanced technologies where BIM integrates to sustainable strategies to improve building performances. Though, the technological capabilities of Green BIM are evident, use of Green BIM has been limited only for design and construction phases of buildings. Professionals in construction industry are still struggling in implementing Green BIM for existing buildings, due to the difficulties of collecting information during operation and maintenance phases that are required for the use of Green BIM. As different Green BIM tool needs different data requirements, building owners and facility managers are reluctant in using Green BIM for existing buildings. Hence, the data requirements have been a considerable issue that should be addressed. Further, the way of utilizing Green BIM for existing buildings is also questionable to achieve sustainability. Besides, the actual barriers and hurdles of Green BIM for existing buildings are vague and different studies have highlighted subjective opinions from different views and insights. Hence, this study aimed to review the existing knowledge on aforementioned area and to identify the gaps in prevailing studies for the implementation of Green BIM in existing buildings. Findings of literature review revealed different data requirements for various Green BIM tools, techniques and how it can be used for sustainable strategies. The findings further highlighted the existing gaps where more studies need to be done in the same area.

Keywords: *Building Information Modelling, Green BIM, Building performance, Sri Lanka.*

1. Introduction

There is an increasing awareness to reduce the escalating demand of energy in buildings, while ensuring the effective utilization of environmental resources in constructions (Autodesk, 2005). In this regard, construction industry professionals have been exposed to number of challenges in assuring environmentally sound construction practices (Hong, Chou & Bong, 2000). However, sustainability as a contemporary conception has widely being used in construction industry as a solution for building energy (Wong & Fan, 2013). Though the concept of sustainability was attended as a tremendous approach to reduce the building energy, still the construction industry is the main contributor of carbon emissions in buildings (Oduyemi & Okoroh, 2016). As revealed in statistical findings, the quantitative value of use of energy is still recorded a considerable amount in constructions even though sustainable strategies are used during construction processes (Wong & Zhou, 2015).

Addressing the aforementioned issue, Building Information Modelling (BIM), resulted modern technological approaches, which could be used to analyse the building performances to cope with sustainability in construction industry (Azhar, 2011). Green BIM was one of such innovative technologies became through BIM by integrating BIM and green building strategies. Green BIM is acknowledged as the application of BIM based simulation tools which help to evaluate building performances comprehensively (McGraw-Hill Construction, 2010). From methodological point of view, Green BIM is defined as a model based process which comes through the generation as well as the management of building related data during its lifecycle to improve the energy efficiency in buildings while attaining sustainable goals (Wu & Issa, 2015).

As proved in the field of research, BIM has increasingly been used for new constructions (Gerber & Rice, 2010). As asserted by Volk et al., (2014), use of BIM for new constructions is high while existing buildings are still not maintained using BIM. Gursel, Sariyildiz, Akin and Stouffs (2009) have further mentioned that, efforts to model existing buildings in BIM environment is considerably less than new constructions. Indicating the same, Wong and Fan (2013) stated that there is a shortage in using BIM for existing buildings. Gu and London (2010) also mentioned that, even though the use of BIM has been expanded, its practical potential should be assessed for existing buildings. Volk et al., (2014) revealed that, there are challenges for the implementation of BIM technologies for existing buildings. Further to, Volk et al (2014), these challenges prevail due to the issue of incomplete and missing building information of existing buildings that are required for BIM. Moreover, as indicated by Wong and Zhou (2015), as the requirement of different data for different BIM based tools and techniques is unknown, there is an issue in the application of BIM technologies for existing buildings. Further, as stated by McArthur (2015), there are various risks and challenges in finding required data to implement BIM technologies for existing buildings.

According to the aforementioned information, use of BIM technologies for existing buildings is less and Green BIM as such technology has also been discussed with same issues when applying for existing buildings. Importantly, a correct method or a way of identifying the challenges associated with data acquisition and management that are required to implement Green BIM for existing buildings is also uncertain. Hence, this study focused to review the existing knowledge to identify what are the data requirements for the use of Green BIM for existing buildings and how to identify the challenges of getting and managing data requirements for Green BIM. Considering the literature findings, this study developed a conceptual framework to identify such challenges for the use of Green BIM for existing buildings addressing the issues discussed above.

2. Findings of the Literature Review

Green BIM technology basically involves two steps including model creation and simulation (Azhar et al, 2010). These two steps are separately conducted in this technology, using BIM designing software and BIM simulation software including variety of input data for each software. BIM simulation software integrates different types of Green BIM techniques or sustainability analysis including energy analysis, thermal analysis, solar analysis, lighting and shading analysis, acoustic analysis and value and cost analysis. To conduct these analysis, different input data should be entered in to BIM software. Figure 01 shows typical input data requirements exchanged between BIM design software and simulation software in BIM-based sustainability analyses as proposed by Bahar, Pere, Landrieu and Nicolle (2013)

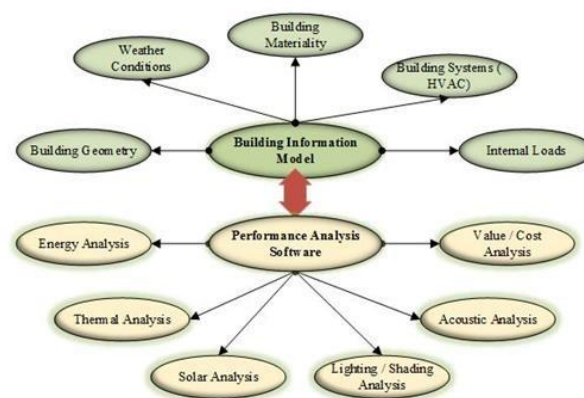

Figure 01. BIM based sustainability analysis

While different studies have proposed different data requirements, this study identified input data requirements separately under Green BIM techniques and tools.

2.1. INPUT DATA REQUIREMENTS FOR GREEN BIM TECHNIQUES

Green BIM techniques are identified as green strategies or types of building performance analysis that are available in Green BIM technology. These techniques basically involved in building performance analysis or simulations in different criterion. Identification of correct input data was an issue highlighted in the literature in relation to the use of Green BIM for existing buildings. Thus, this study investigated various research papers considering the key words including BIM, Green BIM, and building performance analysis and simulation tools. As per the opinions and scientific knowledge identified from prevailing literature, Green BIM techniques require different input data to carry out Green BIM based building simulations. The input data identified for Green BIM techniques in this study are summarized in table 01. It is important to note that different studies and authors have highlighted different data requirements for each technique sometimes which are generally applicable for both BIM based and non-BIM based green strategies.

Table 1: Input data requirements for Green BIM techniques

Green BIM Techniques / Simulations / Analysis	Input Data
Acoustic Analysis	Building Geometry <ul style="list-style-type: none"> ✓ Volume of rooms ✓ Each face of the rooms ✓ Area of each face Sound Sources <ul style="list-style-type: none"> ✓ Position and power of the sound source ✓ Sound Intensity Level ✓ Power of the sound source ✓ Distance from the sound source Audience <ul style="list-style-type: none"> ✓ Position of the audience Finish materials of rooms <ul style="list-style-type: none"> Material Properties <ul style="list-style-type: none"> ✓ Sound absorption coefficient at series of octave band frequencies Absorption at various frequencies Time
Daylighting Analysis	<ul style="list-style-type: none"> ✓ Building Geometry ✓ Information about interior spatial organization and zones ✓ Material properties ✓ Properties of shading surfaces
Thermal Analysis	<ul style="list-style-type: none"> ✓ Building Geometry ✓ Information about interior spatial organization and zones ✓ Material properties ✓ Properties of shading surfaces
Value and Cost Analysis	<ul style="list-style-type: none"> ✓ Operation and maintenance costs within an appropriate level or elemental division of the project ✓ Specification of material in terms of the design brief and service life required ✓ Factors affecting component deterioration and failure ✓ Maintenance, preservation and operational cost variables ✓ Net present value indicators for the life cycle of assets
Energy Analysis	Element material constructions and associated thermal properties <ul style="list-style-type: none"> ✓ U-values or heat coefficients ✓ R-values or measure of thermal resistance HVAC and hot water system types and efficiencies <ul style="list-style-type: none"> Lighting types, density and efficiency Building occupancy <ul style="list-style-type: none"> Plug loads, such as appliances and electronic devices <ul style="list-style-type: none"> ✓ Power consumptions (w/kw) of appliances and devices ✓ Sensible heat gains ✓ Latent heat gains Internal heat gains from plug loads and occupancy <ul style="list-style-type: none"> Building natural infiltration rate (air leakage) Natural ventilation (eg: opening and closing of windows) Thermostat set point temperatures Operating schedules

3. Input Data Requirements for Green BIM Tools

BIM comprises a set of tools or software for structural, energy, costing, lighting, acoustic, airflow and other analyses which are integrated in design activities and simulations. Many of capabilities of these tools have been out-lined and realized its potential in the research literature (Middlebrooks, 2008). Green BIM tools can basically be divided into two categories as design tools and simulation tools. BIM design tools are used to model the basic design of buildings while simulation tools are used for building performance analyses (Rathnasiri, Jayasena & madushanka, 2017).

Table 02. Input data for Green BIM tools

Input Data	Green BIM Tools						
	Ecotect	GBS	IES VE	Energy Plus	Eco-Designer	eQUEST	Design Builder
Building Geometry	<input type="checkbox"/>	<input type="checkbox"/>	<input type="checkbox"/>	<input type="checkbox"/>	<input type="checkbox"/>	<input type="checkbox"/>	<input type="checkbox"/>
Building orientation	<input type="checkbox"/>	<input type="checkbox"/>	<input type="checkbox"/>	<input type="checkbox"/>	<input type="checkbox"/>	<input type="checkbox"/>	<input type="checkbox"/>
Weather data	<input type="checkbox"/>	<input type="checkbox"/>	<input type="checkbox"/>	<input type="checkbox"/>	<input type="checkbox"/>	<input type="checkbox"/>	<input type="checkbox"/>
Building envelop	<input type="checkbox"/>	<input type="checkbox"/>	<input type="checkbox"/>	<input type="checkbox"/>	<input type="checkbox"/>	<input type="checkbox"/>	<input type="checkbox"/>
HVAC type	<input type="checkbox"/>	<input type="checkbox"/>	<input type="checkbox"/>	<input type="checkbox"/>	<input type="checkbox"/>	<input type="checkbox"/>	<input type="checkbox"/>
Building type/	<input type="checkbox"/>	<input type="checkbox"/>	<input type="checkbox"/>	<input type="checkbox"/>	<input type="checkbox"/>	<input type="checkbox"/>	<input type="checkbox"/>
Glazing type	<input type="checkbox"/>	<input type="checkbox"/>	<input type="checkbox"/>	<input type="checkbox"/>	<input type="checkbox"/>	<input type="checkbox"/>	<input type="checkbox"/>
Lighting power density	<input type="checkbox"/>	<input type="checkbox"/>	<input type="checkbox"/>	<input type="checkbox"/>	<input type="checkbox"/>	<input type="checkbox"/>	<input type="checkbox"/>
Equipment power	<input type="checkbox"/>	<input type="checkbox"/>	<input type="checkbox"/>	<input type="checkbox"/>	x	<input type="checkbox"/>	<input type="checkbox"/>
density	<input type="checkbox"/>	x	<input type="checkbox"/>	<input type="checkbox"/>	x	<input type="checkbox"/>	<input type="checkbox"/>
Occupancy Sch	<input type="checkbox"/>	x	<input type="checkbox"/>	<input type="checkbox"/>	x	<input type="checkbox"/>	<input type="checkbox"/>
Lighting Schedule	<input type="checkbox"/>	x	<input type="checkbox"/>	<input type="checkbox"/>	x	<input type="checkbox"/>	<input type="checkbox"/>
Equipment Sche.	<input type="checkbox"/>	x	<input type="checkbox"/>	<input type="checkbox"/>	<input type="checkbox"/>	<input type="checkbox"/>	x
Fuel type	<input type="checkbox"/>	x	<input type="checkbox"/>	<input type="checkbox"/>	<input type="checkbox"/>	<input type="checkbox"/>	<input type="checkbox"/>
Operable windows	<input type="checkbox"/>	x	<input type="checkbox"/>	<input type="checkbox"/>	<input type="checkbox"/>	<input type="checkbox"/>	<input type="checkbox"/>
Operable window schedule	<input type="checkbox"/>	x	<input type="checkbox"/>	<input type="checkbox"/>	<input type="checkbox"/>	<input type="checkbox"/>	x
System energy efficiency	<input type="checkbox"/>	x	<input type="checkbox"/>	<input type="checkbox"/>	x	<input type="checkbox"/>	x
Roof Reflectance	<input type="checkbox"/>	x	<input type="checkbox"/>	<input type="checkbox"/>	<input type="checkbox"/>	<input type="checkbox"/>	<input type="checkbox"/>
User-defined glazing spec.	<input type="checkbox"/>	x	<input type="checkbox"/>	<input type="checkbox"/>	<input type="checkbox"/>	<input type="checkbox"/>	<input type="checkbox"/>
construction properties							
MEP BIM Model	x	x	<input type="checkbox"/>	x	x	x	x
Water efficient fixtures	x	x	<input type="checkbox"/>	x	x	<input type="checkbox"/>	x
HVAC Compo.	x	x		<input type="checkbox"/>	<input type="checkbox"/>	x	x
Customizable occupancy schedule	<input type="checkbox"/>	x		<input type="checkbox"/>	x	<input type="checkbox"/>	x
Customizable lighting schedule							
Customizable equipment sche.	<input type="checkbox"/>	x	<input type="checkbox"/>	<input type="checkbox"/>	x x		x x
HVAC fan power	<input type="checkbox"/>	x	<input type="checkbox"/>	<input type="checkbox"/>		<input type="checkbox"/>	
Interior temperatures					x x		x x
Utility Rates					x		x
	<input type="checkbox"/>	<input type="checkbox"/>	<input type="checkbox"/>	<input type="checkbox"/>		<input type="checkbox"/>	
	<input type="checkbox"/>	<input type="checkbox"/>	<input type="checkbox"/>	<input type="checkbox"/>		<input type="checkbox"/>	
	<input type="checkbox"/>	<input type="checkbox"/>	<input type="checkbox"/>	<input type="checkbox"/>		<input type="checkbox"/>	

After the identification of input data requirements that need to be entered for Green BIM tools and techniques, this study intended to identify the way of utilizing Green BIM for existing buildings. Often, the studies which were related to BIM and Green BIM have highlighted the use of Green BIM for design and construction phases of buildings. Kriegel and Nies (2008), have indicated the ways that BIM can aid in the aspects of sustainable design including,

- Building orientation (which can reduce the cost of the project),
- Building massing (to analyze building form and optimize the building envelope),
- Day lighting analysis,
- Water harvesting (reducing water needs in a building),
- Energy modelling (reducing energy needs and analyzing how renewable energy options can contribute to low energy costs),
- Sustainable materials (reducing material needs and using recycled materials) and
- Site and logistics management (to reduce waste and carbon footprints)

Azhar et al. (2009) developed a conceptual framework for BIM-based Sustainability Analysis as presented in Figure 02. The figure indicates project phases, sustainability analysis/Green BIM techniques and interactions of external entities such as customers or project partners. Though this framework presents the use of Green BIM techniques at project phases with project participants, a systematic guidance for Green BIM implementation and to avoid its challenges is not provided.

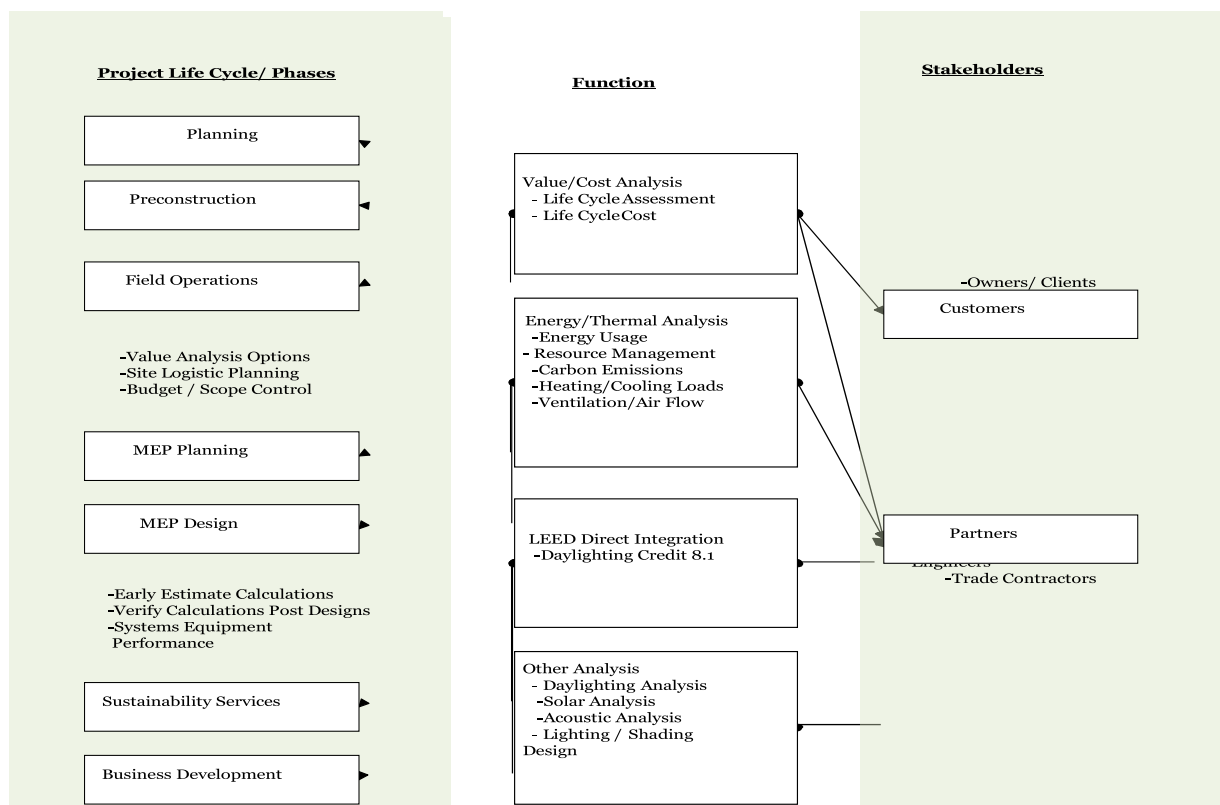

Figure 02. Conceptual Framework BIM based analysis

Similarly, Bahar et al (2013), have proposed a workflow for thermal analysis. This workflow presents the involvement of BIM only for thermal analysis in Green BIM. Azhar et al. (2009), have also developed a conceptual framework for BIM based sustainability analysis of a project. Further, Krygiel and Nies (2008), have conducted several case studies by implementing BIM for LEED and other green building projects. Biswas et al. (2013), have developed a tool incorporating BIM technology to the rating and certification of green buildings to evaluate the environmental consequences of design decisions. Barnes and Castro-Lacouture (2009), have suggested that 13 credits and 1 prerequisite in the LEED rating system can be directly acquired by using the Autodesk Revit. Gandhi and Jupp (2014), have examined the potential application of BIM for the Australian Green Star Building certification.

However, even though, several studies have been undertaken discussing the ways of integrating BIM for sustainability, a systematic way of applying Green BIM and identifying its challenges for existing buildings is still not reviewed. It is noteworthy that aforementioned studies have been basically proposed for the use of Green BIM during the design and construction stages. Thus, according to the literature, it is obvious that there is a need of more studies to investigate how Green BIM can be utilized for existing buildings. Further, Volk et al. (2013) mentioned that there are challenges in implementing BIM technologies for existing buildings. Khaddaj and Srour (2016), have also stated that there are challenges faced by modellers in handling the uncertainties of existing data for BIM based refurbishment methods. According to Li (2012), as design and construction phases are finished for a long period ago, availability of required BIM information for existing buildings is a significant issue. Wang and Cho (2015), have further stated that, as built data required for BIM implementation, are always not available in existing buildings. Liu et al (2015), has also described the main reason which hinders utilization of BIM technologies for operations and maintenance phase as unavailability of proper information to develop 3D as built models. Moreover, Liu et al (2015), has proved that existing 2D as built drawings are inefficient and inaccurate at the operation phase of buildings. In addition, as mentioned by Khaddaj and Srour (2016), developing a BIM model for existing buildings requires a significant effort of data collection. Accordingly, the aforementioned literature reveals that there are uncertainties and gaps in the field of research, in relation to data requirements for the application of Green BIM for existing buildings.

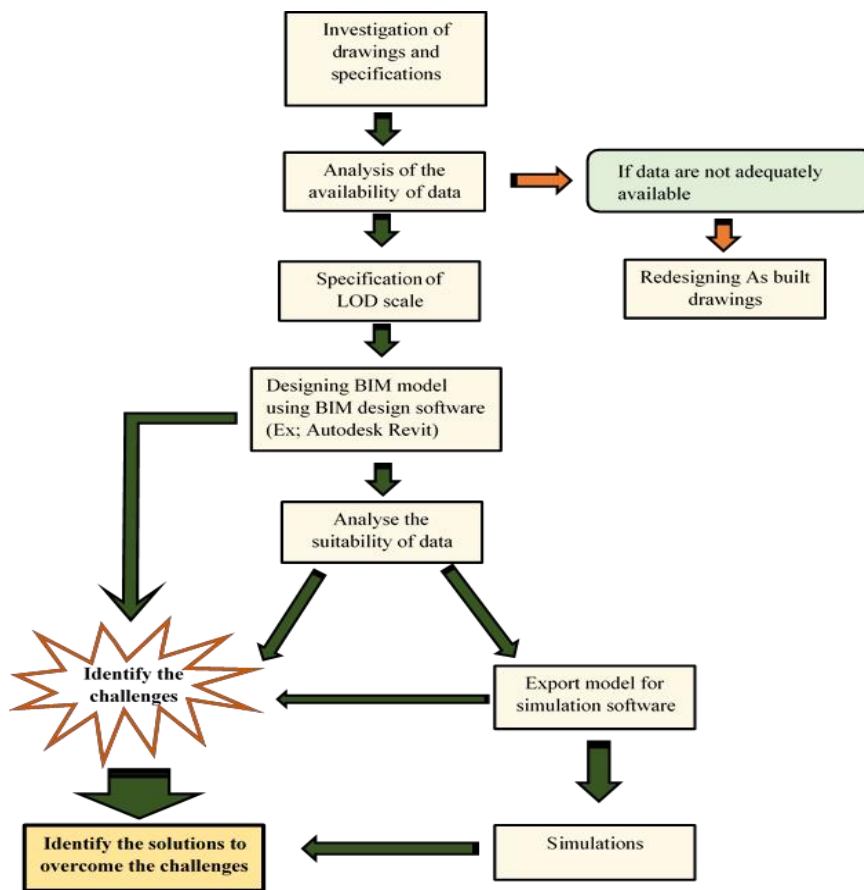

Figure 03. Conceptual Framework to identify the challenges

Though this literature mentioned that there are challenges and risks in acquiring and using BIM data from existing buildings for BIM technologies, the actual challenges and issues are still not unknown. Thus, it is needed to identify first, what are the actual challenges which occur in practical context in implementing BIM technologies (in this study, Green BIM technology) for existing buildings. Focusing on the existing literature and this research gap, this study intended to develop a conceptual framework to identify those challenges for the use of Green BIM technology for existing buildings. The developed framework is presented in figure 03. The application of Green BIM technology is basically involved in BIM model creation and simulations (Azhar et al. 2010), and thus, this framework has been developed

identifying these two steps. The first step of the framework is to investigate the drawings and specifications of existing buildings to which Green BIM is going to be applied. This step is important as the literature reveals that data are not adequately available at operation phase of existing buildings. Hence, it is important to identify the available drawings and specifications of the existing building first. As the second step, an analysis is recommended to carry out for the availability of data by conducting a comparison with the input data identified from literature. At this step, it is needed to recognize the level of data available in the existing building and in case that the level of data availability is not sufficient to proceed, it is recommended to redesign as built drawings for the building. As the next step, Level of Detail (LOD) scale needed to be specified to determine at which scale Green BIM can be applied. LOD specifies the applicable level to implement BIM technologies with the available data. After the specification of LOD scale, basic BIM model for the building can be designed with the available data. Autodesk Revit can be suggested as the most popular BIM designing software. This step is important to identify the practical challenges adhered with basic BIM model creation of the building and at the same time, it is needed to analyse the suitability of available data so that the challenges and issues of available data can be realized. It also helps to confirm the reliability of input data used for model creation. After the creation of BIM model, the next step is suggested to conduct Green BIM techniques or simulations and again it is important to identify the challenges during this step. Within the model creation and simulations, it is important to identify the challenges and finally these challenges can be analysed to identify possible solutions to overcome the challenges.

4. Conclusion

This study focused to identify what are the actual data requirements needed for Green BIM and to determine possibilities to develop a conceptual method to identify the challenges related to input data requirements of Green BIM and its implementation. Through a thorough literature review, this study come up with findings highlighting the data requirements needed for Green BIM tools, techniques and existing knowledge upon the use of Green BIM for existing buildings. Finally, considering the available literature, a conceptual framework was developed for the identification of challenges. This framework will be a guidance for further studies to determine actual challenges and how to overcome challenges for the effective use of Green BIM for existing buildings.

5. Acknowledgement

This work was supported by Senate Research Committee of University of Moratuwa under the Research Grant of SRC/LT/2017/20.

6. References

- Autodesk. 2005 Building Information Modeling for Sustainable Design. Autodesk Combustion 4 Fundamentals Courseware
- Azhar, S., Brown, J., & Farooqui, R. 2009, BIM-based sustainability analysis: An evaluation of building performance analysis software. In Proceedings of the 45th ASC annual conference
- Azhar, S. 2011, Building Information Modeling (BIM): Trends, Benefits, Risks, and Challenges for the AEC Industry. Leadership and Management in Engineering
- Azhar, S., Brown, J. W., and Sattineni, A. 2010, A Case Study of Building Performance Analyses Using Building Information Modeling. Proceedings -- The 27th International Symposium on Automation and Robotics in Construction.
- Barnes, S., & Castro-Lacouture, D. (2009). BIM-Enabled Integrated Optimization Tool for LEED Decisions. *Computing in Civil Engineering (2009)*. doi:10.1061/41052(346)26
- Biswas, T., Wang, T.H. and Krishnamurti, R. 2008, Integrating sustainable building rating systems with building information models. In Proceedings of the 13th international conference on computer aided architectural design research in Asia. ChiangMai, Thailand.
- Becerik-Gerber, B., & Rice, S. 2010, The perceived value of building information modeling in the US building industry. *Journal of Information Technology in Construction*
- Bahar, Y., Pere, C., Landrieu, J., Nicolle, C. 2013, A Thermal Simulation Tool for Building and Its Interoperability through the Building Information Modeling (BIM) Platform.
- Krygiel, E., Nies, B., 2008, Green BIM: Successful Sustainable Design with Building Information Modeling
- Gandhi, S., and Jupp, J. R. 2013, Characteristics of Green BIM: Process and Information Management Requirements. *Product Lifecycle Management for Society*, 596-605. doi:10.1007/978-3-642-41501-2_59
- Gu, N., London, K. 2010, Understanding and facilitating BIM adoption in the AEC industry. *Automation in Construction*.

- Gursel, I., Sariyildiz, S., Akin, Ö., and Stouffs, R. 2009, Modeling and visualization of lifecycle building performance assessment. *Advanced Engineering Informatics*
- Hong, T., Chou, S., Bong, T. 2000, Building simulation: an overview of developments and information sources. *Building and Environment*
- Khaddaj, M., Srour, I. 2016, Using BIM to Retrofit Existing Buildings. *Procedia Engineering*.
- Liu, S., Meng, X., Tam, C. 2015, Building information modeling based building design optimization for sustainability. *Energy and Buildings*
- McArthur, J. 2015, A Building Information Management (BIM) Framework and Supporting Case Study for Existing Building Operations, Maintenance and Sustainability. *Procedia Engineering*.
- McGraw-Hill Construction. 2010, The business value of BIM in Europe. McGraw-Hill Construction. Bedford: McGraw-Hill Construction.
- Oduyemi, O., Okoroh, M. 2016, Building performance modelling for sustainable building design. *International Journal of Sustainable Built Environment*.
- Rathnasiri, H.W.T.P., Jayasena H.S. 2016, Adoptability of Green BIM technology for the Green Buildings in Sri Lanka. In proceedings of 6th World Construction Symposium
- Volk, R., Stengel, J., Schultmann, F. 2014, Corrigendum to “Building Information Modeling (BIM) for existing buildings – Literature review and future needs” [*Autom. Constr.* 38 (March 2014) 109–127]. *Automation in Construction*.
- Wang, C., Cho, Y. K. 2015, Application of As-built Data in Building Retrofit Decision Making Process. *Procedia Engineering*.
- Wu, W., Issa, R. R. 2015, An Integrated Green BIM Process Model (IGBPM) for BIM Execution Planning in Green Building Projects.
- Wong, J. K., Zhou, J. 2015, Enhancing environmental sustainability over building life cycles through green BIM: A review. *Automation in Construction*
- Wong, K., Fan, Q. 2013, Building information modelling (BIM) for sustainable building design. *Facilities*, 31(3/4)

Samarawickrama, Sumanthri, et al (eds), 2018, "Sustainability for people - envisaging multi disciplinary solution": *Proceedings of the 11th International Conference of Faculty of Architecture Research Unit (FARU), University of Moratuwa, Sri Lanka, December 08, 2018* Galle pp. 402–410. ©

IMPLEMENTATION OF RIBA PLAN OF WORK (2013) AT PRE- CONTRACT PHASE TO MINIMIZE CONFLICTS OF CONSTRUCTION PROJECTS IN SRI LANKA

KANCHUKA WITHANAGE¹ & NAYANATHARA DE SILVA²

Department of Building Economics, University of Moratuwa, Sri Lanka

¹kanchukathilakshana@gmail.com, ²endds@uom.lk

Abstract

The construction industry holds a wide range of closely incorporated organizations and a diverse range of professionals. Therefore conflicts are obvious in construction projects due to the involvement of multidisciplinary with multiple objectives. RIBA plan of work is well- established construction work plan for project planning and management. This research aims to implement RIBA plan of work (2013) at pre contract phase from the perspective of conflicts avoidance in Sri Lankan construction projects. A questionnaire based survey was performed among construction professionals who involved in pre contract phase of construction projects to identify the most important pre contract RIBA tasks for conflict avoidance, to identify fairly practicing pre contract RIBA tasks in Sri Lanka and finally to identify possible enablers to promote RIBA plan of work (2013) in Sri Lankan construction industry. Out of twenty pre contract RIBA tasks, eighteen tasks were identified as the most important tasks for conflict avoidance. Further, out of those important eighteen tasks, only seven tasks were identified as fairly practicing tasks in Sri Lankan construction industry. Finally fourteen possible enablers were proposed to implement not practicing tasks and through that to promote RIBA plan of work (2013) as conflict avoidance tool.

Keywords: *Construction industry, RIBA plan of work (2013), Conflict avoidance, Pre contract phase*

Introduction

Construction industry is one of the leading, risky, uncertain, complex and labour intensive sector, among all other major sectors in the world (Dainty, Green, & Bagihole, 2007). In addition, Walker (2002) describes that construction is a large and complex industry comprising many types and sizes of organizations and a diverse range of professionals and other representative bodies; clients, professional practices, contractors and specialist firms all have their own agenda and allegiances. This sector presents a complex, problematic and yet fascinating context within which to explore the creation, enactment and impact of employment practices (Dainty, Green, & Bagihole, 2007).

Businesses in construction sector face major uncertainty events in meeting their projects planned objectives in the most cost effective manner and at a desired quality (Othman, Hassan, & Pasquire, 2004). Furthermore, it has one of the most dynamic, risky and challenging characteristics though with a rather weak reputation in risk management in comparison to other industries (Wood, Dermott, & Swan, 2002). These risky and challenging characteristics are the most common conflict initiating factors in industry.

Interactive and lengthy process of designing and building was made the today's construction projects more complex in nature and therefore conflicts are almost ensured (Jaffar, Tharim, & Shuib, 2011). One of the biggest problems in construction is the extent to which the industry separates design from production to a far greater extent than other industries. This particular feature of the industry is still common despite the deficiencies of traditional procurement methods (Cooke & Williams, 2004).

According to Acharya, Lee and Im (2006), conflicts do not exist in the perfect world of construction, but the perfect world of constructions does not exist itself. It seems that conflicts are inevitable to the construction industry especially when most of construction projects are facing with so many uncertainties (Jaffar, Tharim, & Shuib, 2011). Further Yiu and Cheung (2006) add that in the construction industry conflicts sometimes seems unavoidable, due to high variances in interests among

the participants of construction projects. Fenn, Lowe, and Speck (1997) argued that due to an inherent nature of conflicts in construction projects, it is very hard to maintain the atmosphere of cooperation during the process of construction (As cited in Panahi, Moezzi, Preece, Normeza, & Zakaria, 2017). Due to unique nature of the industry and above mentioned characteristics, plenty of construction conflicts can be occurred during the project operations (Burtonshaw & Gunn, 2009).

Conflicts

Conflict has been defined by Kumaraswamy (1997) as a serious difference between two or more beliefs, ideas or interests (as cited in Frieder, 2016). According to Jaffar, Tharim, and Shuib (2011) conflict can be defined as “an active disagreement between people with opposing opinions or principles.” Furthermore Acharya, Lee, and Im (2006) identified that conflict can be defined as a struggle or competition between people with opposing needs, ideas, values, beliefs or goals. In the same way conflict can be defined as a mismatch of goals and values between two or more parties (Fisher, 2000).

Conflicts are generally viewed as a negative aspect by the people (Ohbuchi & Suzuki, 2003). Author further witnessed that conflicts raise hostility and mistrust between members and restrict with organizational functions. But there are some positive aspects also. According to Popovic and Hocenski (2009) those are shape more effective and productive ways of management, motivating new ideas and encouraging reorganization. In addition to that authors stated that conflicts can provide beneficial results also.

RIBA Plan of Work

The RIBA Plan of Work (2013) arranges the process of briefing, designing, constructing, maintaining, operating and using construction projects into a number of important stages (RIBA, 2013). According to RIBA (2013), RIBA plan of work has special features such as acting across the full range of sectors and project sizes, providing straight-forward mapping for all forms of procurement, integrating sustainable design processes and mapping Build- ing Information Modelling (BIM) processes.

Basically there were main six RIBA versions available as 1963, 1967, 1973, 1998, 2007 and 2013. Two latest versions of this plan of work at 2013 and 2007 are the most commonly practicing versions in construction industry which are somewhat different in their content and format.

The latest version of RIBA plan of work; RIBA plan of work 2013 has undergone a radical overhaul. This version has been developed as a flexible tool that allows the creation of a bespoke practice or project plan of work comprising the relevant procurement, programme and planning activities. One of the main feature of the RIBA Plan of Work (2013) is that suitable for many forms of procurement (RIBA, 2013). The RIBA Plan of Work (2013) consists of eight stages defined by the numbers 0–7, and eight task bars which replaces the ‘description of key tasks’ in the RIBA Outline Plan of Work 2007 (Sinclare, 2013). The latest version of RIBA plan (2013) has special features when comparing with the outline plan of work 2007; comprising eight stages and eight task bars, retaining simplicity while adding flexibility, mapping to government’s digital plan of work, including new topics and defining terms and project strategies (RIBA, 2013). According to RIBA (2013) the stages are represented by numbers to avoid confusion with the stages in the RIBA Outline Plan of Work 2007, which were represented by letters. The eight stages of the RIBA Plan of Work (2013) are as strategic definition, preparation and brief, concept design, developed design, technical design, construction, handover and close out and in use.

Use of RIBA Plan of Work (2013) for Conflict Avoidance

Royal Institution of Chartered Surveyors (RICS) has been published a guidance document in 2013 for conflict avoidance which includes following conflict avoidance methods. These methods were not specified for pre contract phase and at both pre contract and post contract phases these strategies can be used for avoidance of conflicts. However as mentioned above, it is important to avoid conflicts at the pre contract phase. Therefore there is a requirement to analyzing conflict factors at pre contract phase and suggesting proper pre contract conflict avoidance strategies. Following table represents that summary of above mentioned conflict avoidance methods and use of RIBA plan of work (2013) under those methods.

Table 1: Use of RIBA plan of work (2013) in conflict avoidance methods

Conflict Avoidance Method	Relevant Pre Contract RIBA Tasks
Good Management	<ul style="list-style-type: none"> • Initial considerations for assembling the project team • Establish project programme • Prepare project roles table and their scope, contractual tree and continue assembling the project team • Review project programme • Review and update project execution plan • The project programme will be finalized with the specific stage dates and detailed programme durations
Clear Contract Documentation	<ul style="list-style-type: none"> • Prepare project roles table and their scope, contractual tree and continue assembling the project team • Finalize with the building contract and all procurement activities
Good Project Management	<ul style="list-style-type: none"> • Initial considerations for assembling the project team • Establish project programme • Review project programme • Review and update project execution plan • The project programme will be finalized with the specific stage dates and detailed programme durations
Partnering and Alliancing	<ul style="list-style-type: none"> • Develop project objectives and quality objectives and finally prepare the initial project brief
Good Client Management	<ul style="list-style-type: none"> • Identify client's business case, strategic brief and other core project requirements • Review feedback from previous projects • Develop project objectives and quality objectives and finally prepare the initial project brief • Prepare risk assessments and agree schedule of services, design responsibility matrix • Agree alterations to brief and issue final project brief
Good Design Team Management	<ul style="list-style-type: none"> • Prepare concept design for structural elements and building services systems • Prepare developed design, including coordinated and updated structural design proposals, building services systems and project strategies • Prepare technical design in accordance with design responsibility matrix and project strategies by including all architectural, structural and building services information • Include specialist subcontractor design and specifications to the particular design
Good Payment Practice	<ul style="list-style-type: none"> • Prepare a preliminary cost estimation by considering developed design

Record Keeping

- Establish project programme
 - Prepare project roles table and their scope, contractual tree and continue assembling the project team
 - Prepare risk assessments and agree schedule of services, design responsibility matrix
 - Review and update project execution plan
 - Prepare a preliminary cost estimation by considering developed design
 - Finalize with the building contract and all procurement activities
-

Research Methodology

Based on the objectives of this research, it was necessary to collect data and identify characteristics of the populations which relates to study area. Therefore this research needed to obtain opinions from number of industry practitioners. By considering characteristics of research approaches, survey approach was considered as more suitable for this study. Survey approach involves the systematic collection of data by interview, questionnaire or other observation method. In this research, data collection was done by questionnaire surveys. Then primary data was analyzed through statistical analysis (one sample t-test) as well as content analysis.

Data Collection Techniques

Questionnaire Survey

The questionnaire survey was conducted to identify importance of RIBA plan of work (2013) to avoid conflicts in Sri Lankan construction industry and degree of implementation of RIBA plan of work (2013) in Sri Lanka and finally to identify possible enablers to promote RIBA plan of work (2013) in Sri Lankan context. Questionnaire survey was prepared using the knowledge which was gained from literature review.

Sampling

In this research implementation and suitability of RIBA plan of work (2013) was assessed through this questionnaire survey. So the selected sample should comprise of consultants (Quantity Surveyors, Engineers and Architects). Consultant list was prepared by referring telephone directory and their web pages. This study was done for implementation of RIBA plan of work (2013) at pre contract phase only. So contractor organizations were not used for the study. Although due to having a lack of knowledge on RIBA plan of work (2013), client organizations also were excluded from this study. All together 70 questionnaires were distributed among consultants who were working at 15 consultant organizations, as 40 questionnaires for Quantity Surveyors, 20 questionnaires for Architects and remaining 10 questionnaires for Engineers. So the sample size was 70 for this study.

Data Analysis Techniques

Statistical One Sample T-Test

Using a statistical analysis, more important tasks for conflict avoidance and highly practiced tasks was identified. For this, one sample t-test was used and the significance level (P value) was identified using the test. The following formula was used in one sample t-test.

$$T = \frac{\bar{Y} - \mu}{SD/\sqrt{N}}$$

Where;

\bar{Y} - Mean importance/practicing level given by the respondents for particular task

μ -Mean of the hypothesized population

SD-Standard deviation of the sample

N-Sample size

Content Analysis

At the end of above analysis, heavily practiced tasks and not practicing tasks were identified. As the last outcome of this research, possible enablers were proposed to implement those not practicing tasks and through that RIBA plan of work (2013) can be promoted in Sri Lankan context. To identify these enablers, content analysis was carried out as a qualitative approach. In here NVivo 11 software was used for this analysis.

Analysis and Discussion

Rate of Respondent

Among all together 70 questionnaires, 42 filled questionnaires were received back. All those 42 questionnaires were used in analysis. Response rate was 60% overall. The response rate for completed questionnaires according to their profession was summarized as shown in following Table.

Table 2: Rate of respondent

Respondent	Distributed	Received	Respondent Rate
Quantity Surveyors	40	28	70%
Architects	20	10	50%
Engineers	10	4	40%
Overall	70	42	60%

Respondents were classified based on their years of experience in construction industry. According to filled questionnaires, 31% from total respondents has experience on both local and foreign construction projects. Out of total respondents 36% has experience on government funded construction projects. Following Table summarizes the respondents' profile on their total experience on construction industry.

Table 3: Experience of respondents

Subject	Total Number	Percentage
Less than 5 years	11	26%
6-10 years	19	45%
11-15 years	4	10%
16-20 years	2	5%
21-25 years	2	5%
26-30 years	3	7%
More than 30 years	1	2%

Approximately 75% from total respondents has more than 5 year experience. Hence the majority of the respondents has more than 5 year experience.

Important RIBA Tasks for Conflict Avoidance

When significance level (p value) is less than 0.05, it was said that there is an enough evidence to reject null hypothesis and accept the alternative hypothesis. Furthermore if t-value is more than 3 (checked mean), it was concluded that the particular task is important in conflict avoidance. So that by evaluating all this data, it was clearly identified that, out of total twenty pre contract RIBA tasks, eighteen tasks having lesser p values than 0.05 while they having t-values more than 3. Following table represents that t-values and p-values (significance level) of selected RIBA tasks in pre contract phase.

Table 4: Important RIBA tasks for conflict avoidance

RIBA work stage	Tasks	Mean	T	P
Strategic	Identify client's business case, strategic brief and other core project requirements	4.55	15.86	0.00

Definition				
	Initial considerations for assembling the project team	4.36	13.41	0.00
	Establish project programme	4.17	9.18	0.00
	Review feedback from previous projects	4.07	9.75	0.00
Preparation and Brief	Develop project objectives and quality objectives and finally prepare the initial project brief	4.31	11.86	0.00
	Undertake feasibility studies and review of site information	4.36	13.41	0.00
	Prepare project roles table and their scope, contractual tree and continue assembling the project team	3.90	6.68	0.00
	Prepare risk assessments and agree schedule of services, design responsibility matrix	4.19	10.42	0.00
Concept Design	Prepare concept design for structural elements and building services systems	4.17	8.58	0.00
	Agree alterations to brief and issue final project brief	4.33	12.58	0.00
	Review project programme	4.14	10.84	0.00
	Review and update project execution plan	4.09	8.98	0.00
Developed Design	Prepare developed design, including coordinated and updated structural design proposals building services systems and project strategies	4.36	11.58	0.00
	Prepare a preliminary cost estimation by considering developed design	4.5	17.61	0.00
	The project programme will be finalized with the specific stage dates and detailed programme durations	4.07	7.76	0.00
Technical Design	Prepare technical design in accordance with design responsibility matrix and project strategies by including all architectural, structural and building services information	4.38	12.24	0.00
	Include specialist subcontractor design and specifications to the particular design	4.09	8.08	0.00
	Finalize with the building contract and all procurement activities	4.55	14.22	0.00

Practicing Level of RIBA Tasks in Sri Lankan Construction Industry

List of the most important pre-contract RIBA tasks for conflict avoidance, were shortlisted according to their “T” values and “P” values of practicing level under this section. In here, not practicing RIBA tasks were selected and then possible motivation enablers were provided for those tasks to promote RIBA plan of work (2013) in Sri Lankan construction industry. When significance level (p value) is less than 0.05, it was said that there is an enough evidence to reject null hypothesis and accept the alternative hypothesis. Furthermore if t-value is more than 3 (checked mean), it was concluded that the particular task is fairly practicing in Sri Lankan context. So that by evaluating all this data, it was clearly

identified that, out of total eighteen pre contract RIBA tasks, seven tasks having lesser p values than 0.05 while they having t-values more than 3. Following table represents that t-values and p-values (significance level) of the fairly practicing RIBA tasks at pre contract phase in Sri Lankan construction projects.

Table 5: Fairly practicing RIBA tasks

RIBA work stage	Tasks	Mean	T	P
Strategic Definition	Establish project programme	3.59	3.72	0.00
Concept Design	Prepare concept design for structural elements and building services systems	3.76	4.49	0.00
	Agree alterations to brief and issue final project brief	3.64	3.95	0.00
Developed Design	Prepare a preliminary cost estimation by considering developed design	4.38	12.24	0.00
	The project programme will be finalized with the specific stage dates and detailed programme durations	3.38	3.57	0.00
Technical Design	Prepare technical design in accordance with design responsibility matrix and project strategies by including all architectural, structural and building services information	3.48	3.47	0.00
	Finalize with the building contract and all procurement activities	4	8.47	0.00

Comparison between Importance of Tasks for Conflict Avoidance and practicing Level of Tasks

Following table represents the importance and practicing level of all RIBA tasks in pre contract phase and it was helped to carry out a comparison regarding the respondent's opinions on importance of tasks for conflict avoidance and practicing level of tasks in organization.

Table 6: Comparison between importance and practicing level of tasks

RIBA work stage	Tasks	(Important/not important) task for conflict avoidance	(Practicing/not practicing) task in organization
Strategic Definition	Identify client's business case, strategic brief and other core project requirements	Important	Not practicing
	Initial considerations for assembling the project team	Important	Not practicing
	Establish project programme	Important	Practicing
	Review feedback from previous projects	Important	Not practicing
Preparation and Brief	Develop project objectives and quality objectives and finally prepare the initial project brief.	Important	Not practicing
	Undertake feasibility studies and review of site information.	Important	Not practicing

	Prepare project roles table and their scope, contractual tree and continue assembling the project team	Important	Not practicing
	Prepare risk assessments and agree schedule of services, design responsibility matrix	Important	Not practicing
Concept Design	Prepare concept design for structural elements and building services systems	Important	Practicing
	Agree alterations to brief and issue final project brief	Important	Practicing
	Review project programme	Important	Not practicing
	Consider construction strategy, including offsite fabrication	Not important	Not practicing
	Develop health and safety strategy	Not important	Not practicing
	Review and update project execution plan	Important	Not practicing
Developed Design	Prepare developed design, including coordinated and updated structural design proposals, building services systems and project strategies	Important	Not practicing
	Prepare a preliminary cost estimation by considering developed design	Important	Practicing
	The project programme will be finalized with the specific stage date and detailed programme durations	Important	Practicing
Technical Design	Prepare technical design in accordance with design responsibility matrix and project strategies .	Important	Practicing
	Include specialist subcontractor design and specifications to the particular design	Important	Not practicing
	Finalize with the building contract and all procurement activities	Important	Practicing

Possible Enablers to Promote RIBA Plan of Work (2013)

The possible motivation enablers were proposed by the respondents to promote the RIBA plan of work (2013) as a conflict avoidance tool. According to the analysis above, eleven pre contract tasks from RIBA plan, were not practiced much in Sri Lankan context since they were very much important in conflict avoidance. So these possible enablers were proposed to implement those tasks. According to the questionnaire, these enablers should be provided by respondents only for not practicing tasks in their organization. Therefore out of 42 respondents only 9 respondents were provided possible enablers in their questionnaires. Those are as follows.

- Need to create a proper data base
- Improve core competencies of consultants on several specified areas
- Implementation of government rules and acts
- Need to consult the design part with qualified lead consultant
- Enhance the capacity of the project team
- Conduct health and safety awareness programme for clients and consultants
- Professional development of the industry practitioners
- Implementation of computer software
- Allow professionals to get foreign exposure
- Usage of innovative techniques
- Enhance client awareness on construction industry
- Allow a sufficient time period for design phase
- Need to implement comparison on previous project

- Regulate the process with proper deadlines

Conclusion

Most of the tasks in strategic definition and preparation and brief stages were not practiced in Sri Lanka due to lack of knowledge of client, conventional operation system of consultant organizations, urgency of clients and lethargy among Sri Lankan consultant professionals. But this initial part is essential to implement since proper briefing and concept of the project will govern the success of the project. However latter part of pre contract phase was somewhat implemented in Sri Lanka due to the essentiality of these tasks to implement a project. So initial briefing, concept designing, detailed designing, preliminary estimation and project programming activities were implemented at pre contract phase of most of the projects. But new concepts and tasks such as project feedback systems, feasibility studies, risk assessments, construction and other strategy implementations and design integrations were not practiced in Sri Lanka due to practicing conventional operation systems in organizations and due to the resistance to change. Out of eighteen tasks, eleven tasks were not properly practiced. That implicates that RIBA plan of work (2013) is not at its' proper implementation level.

Therefore as the final conclusion, it was identified that most of the pre contract tasks in RIBA plan of work (2013) are important in conflict avoidance since majority of them were not practiced much in Sri Lankan context. However by implementing above stated possible enablers, it would assist to promote RIBA plan of work (2013) as a conflict avoidance tool and it would minimize the number of conflicts in the industry. Sri Lankan construction industry practitioners can directly use these findings of the research for implementation of RIBA plan of work (2013) and through that to avoid conflicts. Therefore these findings will be more worthy for the industry.

References

- Aje, O., Odusami, K., & Ogunsemi, D. (2009). The impact of contractors' management capability on cost and time performance of construction projects in Nigeria. *Journal of Financial Management of Property and Construction*, 14(2), 171-180.
- Bertelsen, S. (2003). Construction as a complex system. *Proceedings of IGLC*, 11.
- Burtonshaw, L., & Gunn, S. (2009). Risk and financial management in construction. *Construction Risk Management*.
- Chapman, C., & Ward, S. (2008). *Project risk management process, techniques, and insights* (Vol. 2). John Wiley.
- Cooke, B., & Williams, P. (2004). *Construction planning, programming and control* (Vol. 2). Blackwell.
- Dainty, A., Green, S., & Bagihole, B. (2007). *People and culture in construction*.
- Fisher, R. (2000). *Sources of conflicts and methods of conflict resolution*. Blackwell.
- Gustavsson, T., & Gohary, H. (2012). Boundary action in construction projects: new collaborative project practices. *International journal of managing projects*, 5(3), 364-376.
- Huges, W. (2003). A comparison of two editions of the RIBA plan of work. *Engineering, Construction and Architectural Management*, 10(5), 302-311.
- Jaffar, N., Tharim, A., & Shuib, M. (2011). Factors of Conflicts in Construction Industry. *The 2nd International Building Control Conference 2011*, (pp. 193-202).
- Kellenher, T., Corgan, B., & Dorris, W. (2011). *Construction Disputes: practice guide with forms*. New year, USA: Wolters Kluwer.
- Leung, M., Liu, A., & Ng, S. (2005). Is there a relationship between onstruction conflicts and participants' satisfaction? *Engeeniring, Construction and Architectural Management*, 12(2), 149-167.
- Mitkusa, S., & Mitkusa, T. (2013). *Causes of conflicts in a construction in dustry*. Lithuania.
- Ohbuchi, K., & Suzuki, M. (2003). Three dimension of conflict issues and their effects on resolution strategies in organizational settings. *The international journal of conflict management*, 14(1), 61-73.
- Othman, A., Hassan, T., & Pasquire, C. (2004). Drivers for dynamic brief development in construction. *Engineering, Construction and Architec- tural Management*, 11(4), 248-258.
- RIBA. (2008). Outline plan of work 2007. London. RIBA. (2013). *About Us: RIBA plan of work*. Retrieved from <https://www.ribaplanofwork.com>
- RIBA. (2013). *About Us:RIBA plan of work*. Retrieved from RIBA web site: <https://ribaplanofwork.com>
- RIBA. (2013). *RIBA plan of work 2013 overview*. (D. Sinclair, Ed.) No 66, Portland place, London.
- RIBA. (2013). *RIBA plan of work 2013 presentation*. Retrieved from Wik- ipedia. Rounds, J., & Segner, R. (2011). Competetion, risk and construction company failure *Construction Business Management*, 171-175.
- Sinclare, D. (2013). *RIBA plan of work 2013 overview*. Portland Place, Lon- don.
- Tan, W. (1997). *Practical research methods*. Jurong: Prentice hall. Wood, G., Dermott, P., & Swan, W. (2002). The ethical benefits of trust based partnering:the example of the construction industry. *A Business Re- view*, 4(2), 4-13.

Samarawickrama, Sumanthri, et al (eds), 2018, "Sustainability for people - envisaging multi disciplinary solution": *Proceedings of the 11th International Conference of Faculty of Architecture Research Unit (FARU), University of Moratuwa, Sri Lanka, December 08, 2018* Galle pp. 411–420. ©

SUSTAINABLE APPLICATIONS BEHIND GEOGRAPHICALLY INDIGENOUS PRODUCT CULTURES

A study of village communities in central high valley, Sri Lanka.

DULAJ PERERA. W.¹ & DILSHANI RANASINGHE. W. M. N. ²

Department of Integrated Design, Faculty of Architecture, University of Moratuwa, Sri Lanka.

¹dulaj926@gmail.com, ²dilshaniranasinghe80@gmail.com

Abstract

While going through the existing creative knowledge applications of the present day world, it is a fact that all of them are not applicable to all the contexts that one might come across. Hence there is a need of finding new paradigms in order to develop sustainable knowledge in a way that it would adopt to address any of the creative needs that would arise in different contexts. There are plenty of fossilized knowledge that can be found in the deeper layers of the community, mainly in the indigenous communities which could be extracted to address the present day issues. This research attempts to explore how these geographically indigenous communities respond to their day today needs and sustainable potentials of their product culture. It will analyse the means of knowledge maintenance and transmission, with a particular focus on the day today products as well as at alternative strategies implemented by them. The study was undertaken in selected four geographically indigenous villages in Central high valley, Sri Lanka; Udugaldebokka, Galamuduna, Narangamuwa and Rambukkoluwa. This research used qualitative and quantitative methods to gather factual data through dialogic interviews and video recordings of the same discussion and local literature sources. The whole research process was carried out through hand on experience and observations done on real time product applications within the community. It was guided by the principles of community-based participatory research and was theoretically grounded by the methods of visual ethnography. Followed by an analysis on product application methodologies. Thus based on its findings, research will conclude that geographically indigenous communities of the region are great knowledge holders and serves as an important resource to decode their knowledge to present sustainable design applications by the means of connecting sources and needs, plotting resources, ethical frameworks, exploring alternatives, sharing abilities and framing intentions..

Keywords: *Indigenous, Sustainable Applications, Product Cultures, Creative Knowledge*

1. Introduction

Sustainability focuses on meeting the needs of the present without compromising the ability of future generations to meet their needs (Investopedia, 2018). When one looks at it from an ancient land of Sri Lanka, with thousands of years of history of codified human knowledge, People thought of minute details around people, objects, emotions and existence to understand problems comprehensively and solving it in sustainable a way. The current creative knowledge applications fall short without a respond to many unanswered questions and problems with regard to the integration of contextual need in design (Richie Moalosi¹, 2007).

In order to analyse the knowledge of these communities had used in their own sustainable applications, the places where those are fossilized and still remaining have to be studied and contexts and activity scenarios where such products are being used, have to be studied and analysed.

Over exposure of the indigenous knowledge of Sri Lanka to the main stream and the lack of proper methodologies to preserve the indigenous knowledge have resulted in gradual decline of them from practice and some have already faded away. But the argument that there are some villages which have not yet been exposed to the main stream that still have the indigenous sustainable practices, can be raised with facts. It is through this work that we will develop to start a proper understanding of what will be required to generate sustainable knowledge paradigms that suitable for our own needs.

2. Knowledge of Sustainability, Habitualization and Indigenous Communities.

Human knowledge is not only the product of past experience, but also the product of anticipating the future. Knowing things involves feedforward as well as feedback, anticipating how things may be used, manipulated or acted on in the future and this leads to application. Humans create new knowledge by acting on and working with knowledge. Knowledge creation requires social context and individual contribution. This involves an effort to render tacit or unknown explicit and known. This context base knowledge creation can be seen as pattern in to practice.

2.1 KNOWLEDGE OF SUSTAINABILITY

Biological life on our planet has existed for billions of years. The many forms of life over those years shaped a rich enough environment to permit hundreds billions of different events, manifestations, behavioural patterns, evolutionary streams. Some of those manifestations gave the creatures manifesting them competitive advantage in local environments to sustain. These creatures survived to pass their knowledge of sustainability, sustainable applications and thinking on (Friedman, 2000). Whereas the concept of sustainability is broadly acknowledged as being multidimensional, its various dimensions have brought to light different discourses over time and have often been treated separately. By relying upon a review of the relevant literature which addresses the notion of sustainability, remain diverse and produce everything it needs to remain in balance and to maintain certain levels without depletion (Investopedia, 2018).

2.2 INDIGENOUS COMMUNITIES AND KNOWLEDGE

Every culture have their own knowledge applications but it is important to discuss and define what to gather and where to gather.

“Indigenous communities, peoples and nations are those which, having a historical continuity with preinvasion and pre-colonial societies that developed on their territories, consider themselves distinct from other sectors of the societies now prevailing in those territories, or parts of them. They form at present non-dominant sectors of society and are determined to preserve, develop and transmit to future generations their ancestral territories, and their ethnic identity, as the basis of their continued existence as peoples, in accordance with their own cultural patterns, social institutions and legal systems” (UNDESA, 19-21 January 2004).

As acknowledged in the Principles and Guidelines for the Protection of the Heritage of Indigenous people, indigenous knowledge is a “complete knowledge system with its own concepts of epistemology, and its own scientific and logical validity” (Battiste, 2002, p.7). Among its characteristics there is its practicality and dynamicity, derived mainly from contextual and cultural changes, which requires indigenous peoples to constantly renegotiate with their environment (Sillitoe, 1998), sustaining their knowledge system in constant evolution. Indigenous knowledge “represents generations of creative thought and applications within each individual community, as it struggles with an ever changing set of conditions and problems”. Because of these strong contextual and cultural connections indigenous knowledge becomes an essential part of indigenous peoples’ lives as it provides the necessary means of survival and sustainability.

2.2.1. *Geographically indigenous communities*

“Geographically Indigenous people are regarded as indigenous on account of their descent from the populations which inhabited the country, or a geographical region to which the country belongs, at the time of conquest or colonization or the establishment of present state boundaries and who, irrespective of their legal status, retain some or all of their own social, economic, cultural and political institutions. (ILO, 1989) The argument here is if we can dig deep into their roots we can analyse the most pure version of knowledge. Even though Sri Lanka is exposed to globalization and other global effects, there are still some less exposed indigenous communities trying to overcome their difficulties and seeking to adapt their households to modern life, whilst at the same time retaining or reviving the knowledge of previous generations. The most interesting aspect of these communities are they still practice their day to day activities within their indigenous knowledge range based on sustainability.

2.2.2. *Geographically indigenous product cultures*

Indigenous product cultures; a more specific form of the general concept of product cultures in which a knowledge collaborates with an indigenous community; is a collaborative process between knowledge and the Indigenous community. Just as each Indigenous culture has its own customs and traditions, the initiation of each product are also different. Ranging from a smaller-scale kitchen utensils to a substantial living space, each product met a specific need in its respective context. This characteristic is not specifically different from traditional product practice, but it is particularly important when it comes to applications due to the unique sustainable approaches and few examples were discussed accordingly (see sec; 4.).

3. Identification of Geographically Indigenous Village Communities in Sri Lanka and Their Life Styles

Four selected villages from the high central valley were studied and documented (see attachment 1). The information concerning approximate data of villages which are periodically released by the Ministry of Public Administration and Management, were refined using reports and accompanying stories from travellers and hikers before the research journey. The research sampling focused on knowledge comparability within the documented villages. Further, only civilized lands within the study area that have not been a part of large-scale deforestation were considered because the research addressed indigenous communities led a life associated with the fields and living practices. The resulting study site included 80 km² of forest in Acre, 43 km² of forest in Knuckles, 28 km² of forest in Yahanagala and 22 km² of forest in Hasalaka.

Vast areas of these villages are covered by mountains and bogs, and there are many water streams and rivers. Fog, strong winds, long rains (lasting from December/January until June), wind, and scanty vegetation are only a few of geographic features that illustrate the challenges faced by any creatures living in these areas. Thus, the lifestyle as well as thinking patterns of these indigenous people have been mainly determined by the extreme conditions and the associated severe constraints imposed on human communities. Due to the climate and the contextual natural resource base,



Figure 1, Research journey to the villages
(Source: Authors collection)



Figure 2, People of Galamuduna
(Source: Authors collection)

the agricultural and subsistence practices of these villages differ from those found commonly in main stream village areas. As a result, different sustainable approaches to develop the primary economies are taken by these communities.

The main activities undertaken by these people include Chena cultivation, paddy cultivation, toddy tapping, and farming. Also they have their own craft activities to produce their day to day domestic products. All these activities are normally maintained by one extended family or a group of relatives and oriented towards nature. Tree barks and Clay and buffalo dump are used for the construction of 'warichchi biththi' houses and made with mud and thatched with 'Illuk' leaves. Mainly Rice, 'kurahan', 'kurahan thalapa' and other vegetables from Chena cultivation are consumed, both fresh and processed. Rituals are still practiced which are pretty much linked to the nature.

4. Decoding Sustainable Applications from Identified Product Culture

The most critical phase behind a product application is its thinking phase in which most decisions were made. This means when we have to analyse a thinking behind a product application or a culture by looking at it that in live user scenarios we need to predict and argue on users' behaviour and operation of products or systems. (Popovic, 1983)

The most important step during this decoding process is that the product applications should manifest indigenous villagers' point of view, from initial thinking of the product to their usage in the context. This means that user constraints should be included into this product application analysis from its initial stage and followed throughout the user journey. The nature of their product applications define which kind of methods, strategies, knowledge and thinking patterns were used.

4.1 APPLICATION FOR STIRRING OF FOOD.

Within a community that functions according to the two 'kanna', the 'Pol katu handa' serves as a sustainable application with functionalities that defers with the time. During one season where rice serves as the staple food the 'pol katu handa' is used in cooking rice, whereas the same device is used in making 'kurahan' with the separated tail of the utensil.

- i. The scenario of village ladies using their own 'pol katu handa' for preparing rice.
- ii. The flat thin hole made in the 'pol katta' to get the maximum tightness in to the tail for continues removing and attaching.
- iii. The pointed tail shape which use to tight the tail into the 'pol katta' when it loosen up, because when removing the tail for make 'kurahan thalapa' it gets loosen and the sustainable approach here is to tight towards the pointed direction to get the maximum usage of the product.
- iv. Unusual proportions of the tail, which makes the product multifunctional.

The device is not distinctly identified to be a multifunctional device by the term, but the understanding or the ideology of the ability to shift the functionality of the product according to the two seasons prevail within the community as sustainable application.



Figure 3, Stirring kurahan using the tail (Source: Authors creation)

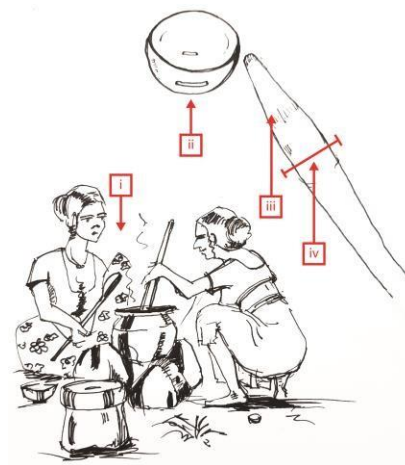

Figure 4, Food stirring (Source: Authors creation)



Figure 5, 'pol katu handa, with the tail (Source: Authors collection)



Figure 6, removed tail from the shell (Source: Authors collection)

4.2 APPLICATION FOR CLEANING THE FLOOR

'Bol pana' is an equipment made out of the twigs of the 'Bol pana' tree used as a product application for cleaning purposes that can be seen within the subjected community. The user interviews revealed that the same equipment is being used in cleaning different places other than their houses including

the 'udu pila' and 'kamatha'. Deeper study on the usage of the equipment and the hand on experience with its usage reveals that the same equipment has been used for cleaning the houses, 'udu pila' and the 'kamatha' respectively with the maturity stages of the 'Bol pana' twigs.

- i. At the younger stage of the twigs which are used to make the product, they are soft and tender and the equipment is used in cleaning the insides of the houses
- ii. When the twigs mature a little they become harder than the early stage and the equipment is used in cleaning the 'udu pila' of the house
- iii. At the well matured stages of the twigs the equipment is used in cleaning the 'kamatha' since they become hard and tough

Thus the study shows that there has been a proper understanding within the community on possibilities of using the same product with changes the product undergoes during its life span accordingly as living product.

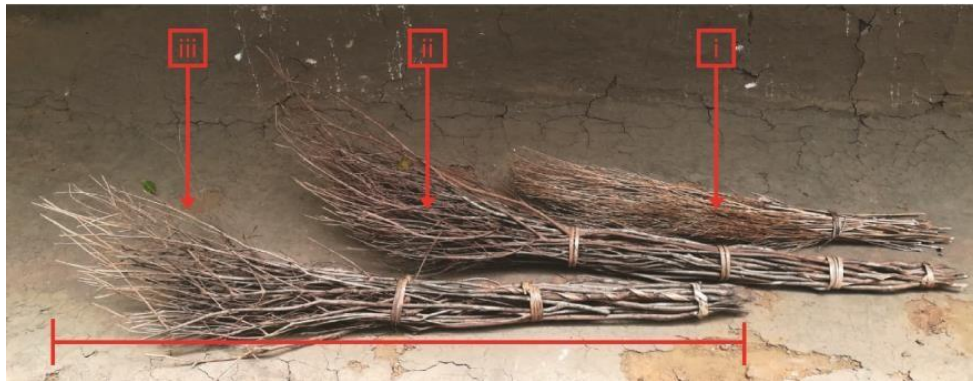

Figure 7, three stages of *Bol Pana* (Source: Authors creation)

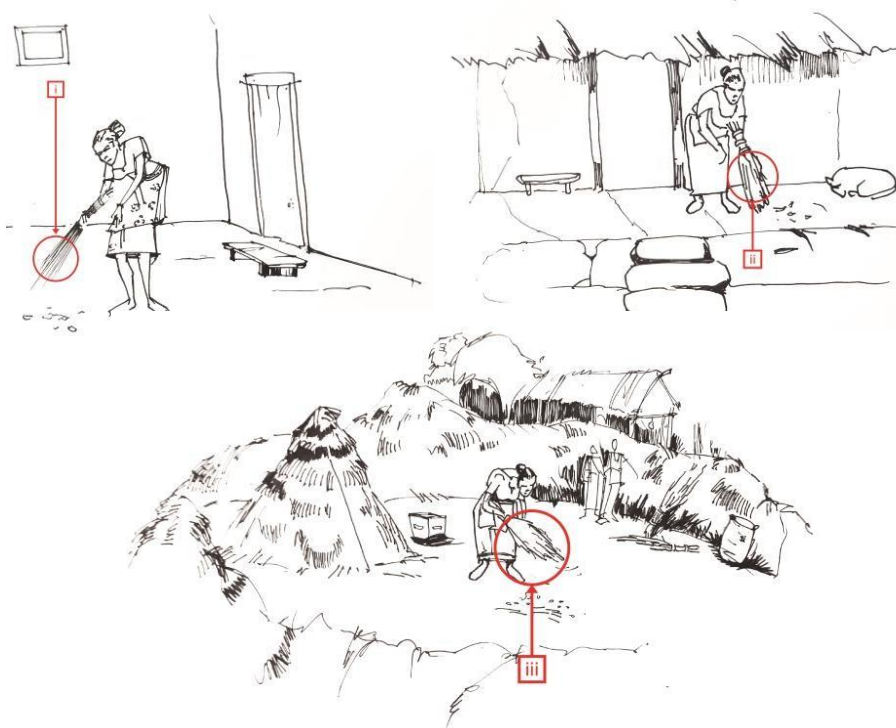

Figure 8, three stages of user scenarios in the context (Source: Authors creation)

4.3 APPLICATION FOR STORING MATS

Unlike the usual ‘*paduru aana*’, the application that can be seen in these communities are made out of a variety of ‘*pan*’ plant found in the forests around these villages and does not contain any motifs. The methodology of storing the mats is very simple that it does not involves any complex tying methods or knots and the wrap that is used to store the mats is also a mat that can serve the functionality same as the stored mats. This particular ideology behind the ‘*paduru aana*’ suggests on giving a functional value even to the packaging as sustainable approach in terms of reducing.

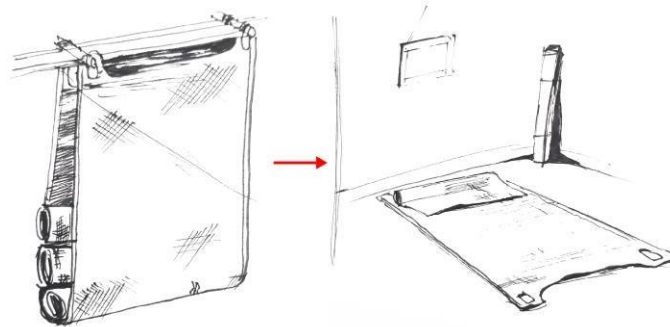

Figure 9, thinking behind application of *Paduru ana* (Source: Authors Creation)

4.4 APPLICATION FOR ALTERING STRAW

‘*Ukunu deththa*’ is a wooden rod with a curvature at one end whereas the ‘*Gadallakaru*’ is also a wooden rod but with a fork at one end. The ‘*Ukunu deththa*’ is used to bring out the straws remained among the ‘*Baru eta*’ which are scattered around the ‘*kamatha*’ after the harvesting. The ‘*Gadallakaru*’ which is similar to an ekel broom which is used to remove the leaves and other scatterings around the Chena. It was clear that the ideology on the relation between the form and function prevails among these communities more importantly they have always tried to find the forms that is ideal for a certain function directly from the nature.

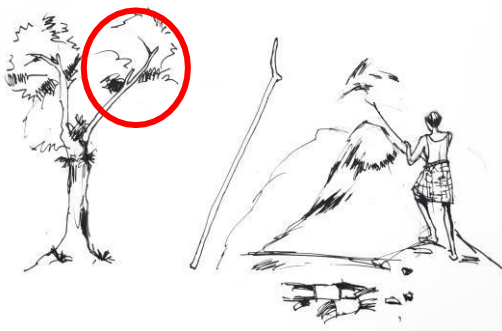

Figure 10, highlighted concepts from *ukunu deththa* (Source: Authors creation)

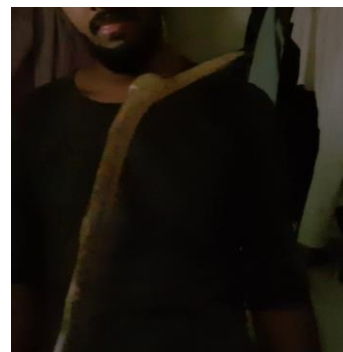

Figure 11, *ukunu deththa* (Source: Authors collection)

4.5 SYSTEM APPLICATION FOR THRESHING RICE

The process of threshing rice can be defined to be a system design where the involvement of people in the process changes according to the size of the machine and the labour required for the machine.



Figure 12, *threshing rice* (Source: Authors collection)

The machine is operated with the involvement of a group of people formed by few families joined together when it requires more space and more labour. When the amount of such requirements reduces, the number of people involved in operation of the machine also reduces. Initially the harvested rice which is with a very rough and hard coating is grinded with a grinding stone which is larger in size. Since the device needs more human labour and space, this is operated by a group of people from two or more families. When a machine like mortar and pestle or the grinding stone is used, it is operated by a single family whereas a single person is involved when working on a machine like 'udu mathe'.

4.5. APPLICATION FOR STORAGE OF RICE

The 'wey path pettiya' is used to both store and sow the 'biththara vee'. The vessel is commonly known as the 'Bata pothu pettiya' where the selected communities of the researcher refers this vessel as the 'wey path pettiya' since the product is made out of 'wey path' which is a plant variety which can be found within the selected geographical location. The 'hee nati' rice grains are the type of rice that is grown in these areas due to the nature of the soil and this particular village community believes the 'wey path' to be ideal for storing this rice grain variety. The raw 'wey path' used in making the vessel gets toughen with the time and the mould become more stable. During the manufacturing phase of the product a special paste is applied to the base which prevents any damage to the vessel by insects. The paste gets absorbed to the 'wey path' with the time and eventually becomes a part of the product.



Figure 13 application of *wey path pettiya* in the context (Source: Authors creation)

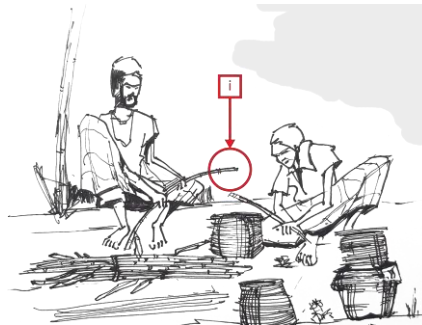

Figure 14, making of *wey path pettiya* (Source: Authors creation)

5. Potentials in Decoded Sustainable Applications for Present Day Creative Knowledge.

5.1 IDENTIFIED SUSTAINABLE PARADIGMS

After analysing the thinking behind each and every product application researcher have identified six sustainable paradigms that can habitualize in to practice, through documented product applications.

5.1.1 Framed Intentions and Goals

This framing acts as a core that directs towards a thought or a sustainable action, for example, 'Pol katu handa' for the product application of stirring, has been framed within a clear intention but with multiple iterations. The usage of multiple iterations and convictions that comes within this framing process is a point that can be integrated in to present knowledge. Such sustainable paradigms lead towards the building of some convictions that are supported by the faith of experiences of a community.

5.1.2 Connected Sources and Needs

Connecting and balancing the sources and needs was significant within their applications. The thinking of these communities has been able to equate the sources to the need within the product applications that involve 'wey path pettiya', 'bol pana', and 'ukunu daththa'. Products like 'wey path pettiya' made out of 'wey path' which is suitable to the variety of rice. However the fact that they are being made out of 'wey path' due to the absence of 'bata pothu', has not been made any obstacle and it has been connected as the suitable source to the need of storing 'hee nati hal' intentionally or not. Here accessing and processing of sources has been based on to direct connect with a need.

5.1.3 Plotted Resources and Opportunities

The usage of the understanding on the way that the resources and opportunities have been plotted within the communities was observed to be a significant factor. Product applications which are related with the livelihood such as *'ukunu deththa'* and *'gadelkaru'* are the best examples that can be given for this particular scenario. Here the paradigm is not created based on the making of the product but with mapping of the required resources. Cutting down a tree branch by obtaining the required shape for the *'ukunu deththa'* while it is in the tree, is a methodology that must be necessarily decoded. Here other than mapping of the resource or the opportunity, re-shaping of the resource with respect to the product also takes place.

5.1.4 Ethical Frameworks through Holistic Models

This paradigm was highlighted among the facts that have been discussed throughout the research. A connection can be observed that this fact and the conviction that comes under the framing intentions. A sustainable application like *'bol panawa'* can be taken as a result of thinking of the process as a whole through an ethical framework rather than considering it part by part. Thinking of a system application related with threshing rice through a holistic model has shown how social equity, participation can be applied in sustainable applications.

5.1.5 Explored Alternatives

Even though some sustainable applications may necessarily not a result of an intentional exploration but that of a gathering and development of a progressive knowledge. Their thinking has been able to find alternatives while associating with holistic models and even segmenting it. As mentioned earlier, it is a gathering of knowledge throughout a time period. Further inquiry regarding this concluded that it is a sustainable paradigm with adaptation and flexibility as its core. Therefore the communities have created the space for any of the identified part of a product application to survive within the context itself. The stone and the wooden part used for the product identified as the grinding stone have been developed to survive within the context with few other alternatives. Even in *'paduru aana'*, the product application is combined with functional alternatives. If there are four members in a family, there are three mats and the other is the same *'padura aana'* that serves as a mat.

5.1.6 Shared Abilities

The applications of these communities have changed progressively. In the meantime, thinking with an aim of sharing the things within it was also a special paradigm that was emphasized. Their ability to share with the environment as well as in community at large is a fact that must be highlighted. These paradigms are interconnected to each other and features of this similar shared thinking can be seen in ethical frameworks and explored alternatives as well. The shared abilities or the shared thinking has been well used sustainably in a system like threshing rice. They have focused on ways where the benefits are divided between all the participants by dividing requirements among themselves when the magnitude of the task is higher, and to divide the effort and the benefit equally with respect to the task at the next step. Sharing of skill sets has been developed with their requirement of surviving themselves within the context. One group of people is expertise on making of the grinding stones whereas one group is expertise on making mortar and pestle. However the fact that their thinking has been built up in a way to share the ideas on the place that these devices will be operated, could be observed.

5.2. INTEGRATING SUSTAINABLE PARADIGMS IN TO PRACTICE

Sustainable paradigms can be integrated into practice by enlarging it, internalizing it, transmitting it, shifting it, re-contextualizing and transforming at certain applications. The potentials of doing so can be concluded as follows. Internalization and reconceptualization are the two main factors that arise mainly because the probability of a knowledge application to fail is more if it cannot adopt to a particular context. During enlarging the knowledge should be done while considering the technological advancements and other background factors rather than directly implementing the paradigms that were decoded from the indigenous communities. This is because the background factors and the nature of the problems that they have come up with a solution might differ from the situation of the modern society. However even at this stage it is much preferred if the holistic model can be maintained without a much effect on it. It is difficult to transmit the extracted sustainable applications directly into the existing creative knowledge as a whole. Instead it is required to be first transmitted into places where the existing creative applications could not achieve sustainability and then observe the results and thus gradually introduce the paradigms as a whole.

6. Conclusion.

Based on the fact that for a creative application to be more sustainable in reaching different contexts it should be based on human adventure and emotional factors. The study has focused on discovering how the relationship of the people of these selected communities with their context and has been related with their sustainable applications, as the research has identified the fact that the existing creative knowledge lack this particular area in its applications resulting it to fail within some contexts. The research has been able to decode six main sustainable paradigms that can be habitualized into present knowledge namely, connected sources and needs,

plotted resources, ethical frameworks, explored alternatives, shared abilities and framed intentions. The research has gone slightly beyond the conventional path and has tried to go deeper in the thinking behind each identified product culture, rather than going deeper into its physical attributes where several number of product applications were studied in this manner. The research thus has focused and discussed on decoded possibilities and identified the potentials that these indigenous sustainable applications could be extracted to the modern creative knowledge by means of enlarging it, internalizing it, transmitting it, shifting it, re-contextualizing and transforming it. One can study deeper into each of these sustainable paradigms in order to discover possible applications and develop practices that are more human and context oriented.

7. References

- Battiste, M., 2002. *Indigenous Knowledge and Pedagogy in First Nations Education - A Literature Review with Recommendations*, Ottawa: National Working Group on Education, 2002.
- Friedman, K. (2000). *Creating design knowledge: from research into practice*. IDATER 2000 Conference. Loughborough: Loughborough University.
- ILO, 1989. *Convention concerning Indigenous and Tribal Peoples in Independent Countries*. Geneva, ILO.
- Investopedia, 2018. Investopedia. [Online]Available at: <https://www.investopedia.com/terms/s/sustainability.asp>
- Popovic, V., 1983 *Product Evaluation Methods and Their Applications* 3.
- Richie Moalosi¹, V. P.-H. (2007). *Culture-orientated Product Design*. International association of societies of design research. Hong Kong: The Hong Kong Polytechnic University.
- Sillitoe, P., 1998. The development of indigenous knowledge: a new applied anthropology. *Current anthropology*. 39(2), pp. 223-252.
- UNDESA. (19-21 January 2004). *Workshop on Data Collection and Disaggregation for Indigenous Peoples: The Concept of Indigenous peoples*. New York: United States.
: UNDESA.

8. Glossary and Index

NOTE. Words in italics are usually Sinhalese unless otherwise stated. The following abbreviations were used;

CP – Central Province

UNDESA - United Nations Department of Economic and Social Affairs ILO - International Labour Organization

Bol pana: A product application for cleaning where *bol pana* is the name of the plant from which the twigs are obtained to make it

He nati hal: A traditional variety of rice

Kanna: A single season of paddy cultivation. There are two “*kanna*” per year

Kurahan: Finger millet

Kurahan gala: A grinding stone made to grind finger millets

Kurahan thalapa: A porridge made out of finger millet

Pol katta: The coconut shell

Pol katu handa: A spoon made with a coconut shell as the head and a wooden stick as the tail

Wey path pettiya: A box or a carrier made out of wey path to store and sow rice

Paduru aana: A holder used to store mats

Udu pila: A veranda attached to the outside of the house

Kamatha: threshing floor or an area of ground that farmers store their harvested paddy *Warichchi gewal*: Traditional rural

houses, made of clay earth walls and thatched roof *Undumathe*: A simple device similar to a drill machine, which is used to

grind cereals *Ukunudeththa*: A wooden rod with a slight curvature at one end which is used to bring out straws among the harvest

Gadellakaru: A wooden rod with a fork at one end which is used to remove leaves around the chena

Illuk: A grass variety

Attachment 1: Documented area (<http://lk.geoview.info/galamuduna,1246578>)

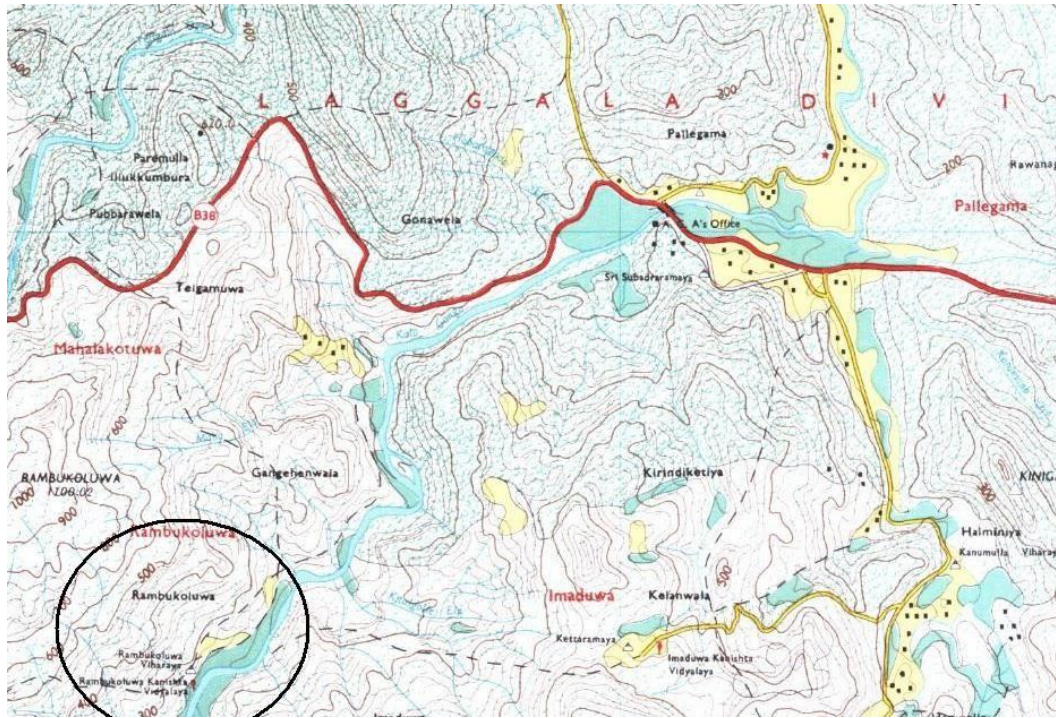

Samarawickrama, Sumanthri, et al (eds), 2018, "Sustainability for people - envisaging multi disciplinary solution": *Proceedings of the 11th International Conference of Faculty of Architecture Research Unit (FARU), University of Moratuwa, Sri Lanka, December 08, 2018* Galle pp. 421-430. ©

A COMPARATIVE ANALYSIS ABOUT THE INDOOR THERMAL ENVIRONMENT OF A ROOM WITH AND WITHOUT TRANSITIONAL SPACE OR THRESHOLD IN TRADITIONAL ROW HOUSES ADJACENT TO A NARROW ALLEY "RUPCHAN LANE" IN OLD DHAKA, BANGLADESH

FATEMA TASMIA ¹, BRISHTI MAJUMDER ² & ATIQR RAHMAN ³

Bangladesh University of Engineering & Technology, Dhaka, Bangladesh

¹fatema.tasmia@gmail.com, ²brishti1001027@gmail.com, ³atiq1488@gmail.com

Abstract

Attaining appropriate thermal comfort conditions for users in built forms, located in a warm and humid sub-tropical climate is a complex phenomenon. Especially, when it is resided at a congested place like old Dhaka Bangladesh, the provision of giving cross ventilation and building with proper orientation is quite challenging. This paper aims to investigate about the indoor thermal environment of a room with and without transitional space or threshold in traditional row houses adjacent to a narrow alley of old Dhaka through field measurements. Transitional spaces are the part of buildings which are used for semi-outdoor household activities, social gathering and it is also proved to provide an indoor thermal effect. The field study has been conducted by collecting thermal data (Temperature, Humidity and Airflow) respectively, among the outdoor narrow alley, transitional space and adjacent indoor. This east west elongated alley has an average width of 2.13 meter (varies from 1.5 to 2.6 meter) holding row houses on both sides. Among different aspects of thermal environment the study of this paper is based on the analysis of temperature of corresponding cases. Other aspects and their variables were considered as constant (especially material) for accuracy and avoidance of confusion. This study focuses on the outcome that can ultimately contribute to the built form configuration of row houses with transitional spaces and in its relation to the adjacent outdoor space while achieving thermal comfort for the people inhabiting. This study will disclose scope for analysis on the thermal quality and performances of the socially interactive spaces like courtyard, veranda or transitional spaces.

Keywords: Built-form, Old-Dhaka, Row Houses, Temperature, Thermal Comfort, Thresholds, Transitional Space

1. Introduction

A row-house is one of a cluster of low-rise residential or shop house buildings that shares one or both side walls and a roofline with the structures next door [1]. A row house is typically just two to five stories in height and home to one or two families [1]. In old Dhaka, Bangladesh the traditional row houses are one of the fine examples of vernacular building. The origin of the Row houses can be traced back to the time of British reign (century), when there was a trend to build decorative double storied row houses or traditional palace like *Zaminder bari* or the house of Landlord. Traditional old houses with relatively large thermal mass, open courtyards, extended verandahs and rooflines can be defined as vernacular buildings. Meanwhile, it is said that these vernacular buildings have been delicately crafted over generations in response to experience of conditions and use [9]. Latest researchers, therefore, endeavored to extract traditional passive techniques active in and around the vernacular buildings for applying them to the modern houses.

1.1 ROW HOUSES IN RUPCHAN LANE

Rupchan Lane area is a part of Sutrapur Thana and group C of the Capital city Dhaka. This part of the traditional city of about 250 m length is more than 200 years old and at present has a predominantly colonial flavour. Most of the buildings of this area were erected on the either sides of a narrow, serpentine road, which are mostly two storied (Figure 01). Other historically significant areas like Shakhari Bazar, Tanti Bazar, Bahadur Shah Park, Ahsan Manzil, B K Das road are situated in the walking distance.



Figure 01: Row Houses around the narrow alley of Rupchan Lane

Adjacent to each other leaving almost no gap in between, these row houses contain courtyards varying from small to large for ventilation and daylight accommodation. The material of these houses are handmade bricks, thickness of wall varies from 0.3 to 0.45 meters. Adjacent to the road some row houses have verandas or small transitional spaces.

The row houses are situated with a narrow frontage of 5m and a long depth of 20 m. The façade of the houses are facing towards either south or north with a total floor area of 100 m². These houses were originally constructed more than 100 to 150 years ago with a strong influence of Indo-saracenic architecture. These houses are currently used as residential blocks having changes in both functional arrangement and physical appearance. According to the users they are residing in these houses for more than three generations. One of the resident Mr. Kartik Ghosh (60) explained how his grandfather constructed this house using local material handmade brick, with timber joists at the roof acting as beams and some elements like iron columns supporting the roof of verandah at first floor, iron railing were imported from abroad.

The row houses are basically two storied with a threshold or transitional space at the front or some houses have direct access from road (Figure 02). The width of the transitional space varies in between 1-1.5 meter (Figure 03), approached by stair or while leveled with road, are accessed directly. Following the transitional space, a living hall or living room cum bed room is located. The indoors are mostly set with furniture (bed, sofa set, reading table, Television/television rack) sometimes over furnished because of the shortage of spaces. Windows are only located at the front side of the room and mostly remain closed due to security purpose at ground floor. Next to this room a bed room and toilet is located and this room contains the upstairs to go to the first floor. Following this room, a courtyard is located and which is common feature of this type of row houses to allow light and ventilation in indoor and provide thermal comfort (Figure 02). But unfortunately in most houses the configuration of courtyard have been changed, either they are largely occupied with room spaces or completely transformed into indoor spaces with wet constructions because of the scarcity of spaces and high demand of livable spaces to facilitate more users of different generations.

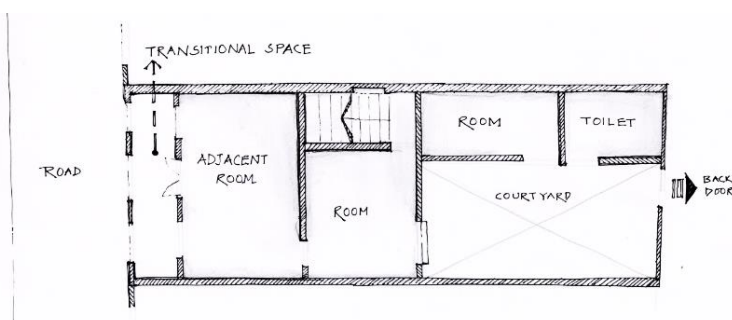

Figure 02: Typical Ground Floor Plan of a Row House



Figure 03: Row Houses with a transitional space at front side with the adjacent room

2. Climate of Bangladesh and Weather of Dhaka:

Bangladesh has a subtropical monsoon climate characterized by moderately warm temperature, high humidity and wide seasonal variations in rainfall. According to Atkinson's widely used classification it can be categorized as *warm-humid* (KoenigBerger et al, 1973). Meteorologically Bangladesh has four distinct seasons.

- *Winter*, from December to February (mean temperature between 12°C and 28°C),
- *Pre-monsoon*, March to May (20°C and 35°C),
- *Monsoon* from June to September (25°C and 32°C)
- *Post-monsoon* covers October and November (17°C and 31°C).

Dhaka is located in central Bangladesh at 23° 42'0"N 90° 22'30"E and experiences a hot, wet and humid tropical climate. The city has a distinct monsoonal season, with an annual average temperature of 25°C and monthly means varying between 18°C in January and 32°C in May. Approximately 87% of annual average rainfall of 2,123 millimeters occurs between May and October [2, 3].

Month	Jan	Feb	Mar	Apr	May	Jun	Jul	Aug	Sep	Oct	Nov	Dec	Year
Average high °C (°F)	26 (79)	30 (86)	34 (93)	36 (97)	35 (95)	34 (93)	33 (91)	33 (91)	33 (91)	32 (90)	30 (86)	27 (81)	31.9 (89.4)
Average low °C (°F)	14 (58)	19 (66)	23 (73)	26 (79)	28 (82)	29 (84)	28 (82)	27 (81)	27 (80)	25 (77)	21 (69)	17 (63)	23.6 (74.5)

Table 01: Climate Data for Dhaka [2,3]

3. Literature Review

The energy consumption for space cooling has been particularly rising in growing cities of Southeast Asia, where hot-humid conditions continue throughout the year. In this region, most of the modern urban houses are constructed of relatively large thermal mass materials such as brick and concrete. The use of large thermal mass materials along with the lack of natural ventilation in these urban houses often results in hot indoor conditions particularly during nighttime [4]. This leads to the excessive use of air-conditioning during the sleep at night. Therefore, application of passive cooling design is required wherever possible to improve the indoor thermal conditions in these modern urban houses for energy-saving. Meanwhile, it is said that vernacular buildings have been subtly crafted over generations in response to experience of conditions and use [2]. Recent researchers, therefore, attempted to extract traditional passive techniques employed in and around the vernacular buildings for applying them to the modern houses [4].

In the warm humid areas where ventilation is one of the two major issue for comfort [the other being shading], buildings of narrow depth usually promote comfort [5]. When arranged around a courtyard they also cast shadows in outdoor spaces and act as a cool sink [6, 7]. The buildings in traditional

settlements of warm humid regions like Bangladesh usually have courtyards allowing air flow from outside to reach them [6, 7].

It has been proved that verandahs or transitional spaces almost act as elongated and wide shading devices in the south façade in the context of Bangladesh [8]. Fixed shading devices or verandah proved to be suitable in the context of Bangladesh climate, if properly designed and installed. The verandah or Transitional spaces also works as a *heat buffer zone* from the outside and keeps the indoor temperature cooler than outdoor. The temperature data shows a 3.5°C temperature difference from out door to indoor in constant air change situation during the warmest part of the day. On the other hand temperature difference between indoor and outdoor having shading devices upon opening is 2.5°C. This 1°C cooler temperature difference indicates reduced energy consumption for thermal comfort. Therefore, for full height openings (up to lintel level) at south façade, it is recommended to use cantilever verandahs with required depth for shading [8].

4. Methodology

As this paper is being developed as a workshop term paper under M.Arch program of Bangladesh University of Engineering and Technology for Thermal Environment and Built Form (ARCH 6101) course, the submission time was in the late winter, specifically in last week of February, the data had to be collected in relatively lower ambient temperatures in relatively cooler environment comparatively with the warmest environment of summer season.

The field measurements were conducted in two-storey traditional row houses from 25th December to 31st December 2017. For Data handling convenience only the data of the warmest day which was December 30, 2017 is being presented among the seven days. The measurements were taken almost 2 hours apart in four houses, House A, House B, House C and House D at the adjacent room to the road or narrow alley (next to the transitional spaces). House A and House B are located at the Northern side of narrow alley (Rupchan Lane) having their frontage exposed to South; Whereas, House C and House D are located at the Southern side of the narrow alley having their frontage exposed to North. In these four houses house A and house C have a veranda or transitional space at the entry or frontal approach and House B and House D are directly approached from road (Figure 04 and Figure 05). Field measurements of temperature, Humidity and Airflow were taken using Hygrometer and Anemometer.



Figure 04: Location Map of "Rupchan Lane"

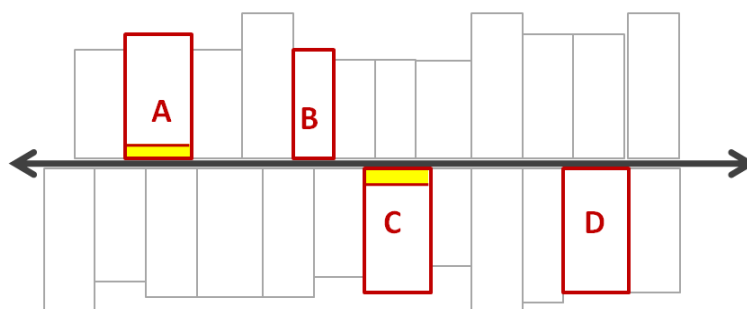

Figure 05: Conceptual diagram of the top view of "Rupchan Lane" with Row Houses

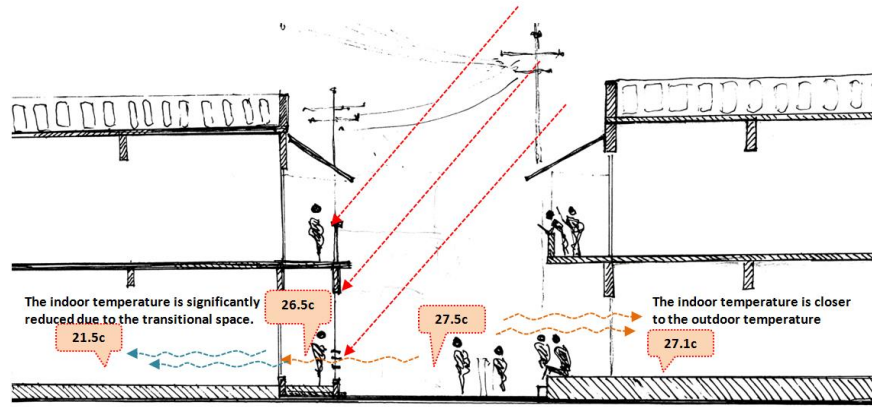
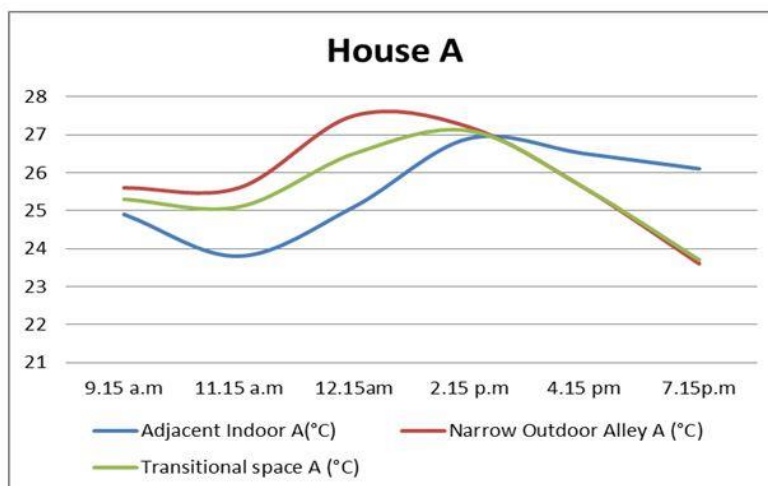

Figure 06: Conceptual Section of Row Houses with and without Transitional Spaces

5. Result and Discussions

5.1 COMPARATIVE ANALYSIS BETWEEN HOUSE A AND HOUSE B

The narrow outdoor alley temperature at the starting time of temperature measurement in House A and House B is 25.6°C and 24.7°C respectively (Table 03, Table 04). The outdoor temperature rises at its peak at around 12.00 pm (Figure 06) and continues till 1.30 pm; it starts to fall from around 2.00 pm and a gradual temperature reduction can be seen towards evening around 7.15 pm. The Temperature in transitional space of House A changes and follow the curve of outdoor temperature, having its peak temperature around 1.30 pm and then tends to fall exactly with the fall of outdoor temperature. A significant difference can be seen in the measured temperature of indoor. The indoor temperature follows the curve of the temperature of outdoor and transitional space with a significant reduction. The indoor temperature raises its peak at around 3.00 pm which is remarkable; it can be caused due to the buffer zone of transitional space (Table 02). The transitional space or the thresholds helps to delayed indoor heating by providing shadow zone and eliminating heat radiation, conduction and convection directly. Whereas in the House B, the narrow outdoor alley temperature at the starting time is 24.7°C , tending to rise and has its peak 28.4°C at around 12.00 and tends to fall towards evening. A significant change can be found that the indoor temperature in House B starts with a higher degree in the morning. With the passing of time it continues to follow the curve of outdoor temperature and continues steadily from around 3.00 pm to 7.00 pm at evening. A significant point can be seen that the adjacent room in House A with transitional space maintains a comparatively higher temperature than the room of House B, although the temperature of narrow outdoor alley and transitional space tends to fall simultaneously (Table 02). So it can be concluded in the words that transitional space contributes in delaying heating in indoor temperature at day time, but from evening to night it kind of traps the heat from disbursing outside by creating a buffer and acts as a hollow thermal mass which delays the process of heat dissipation from indoor.



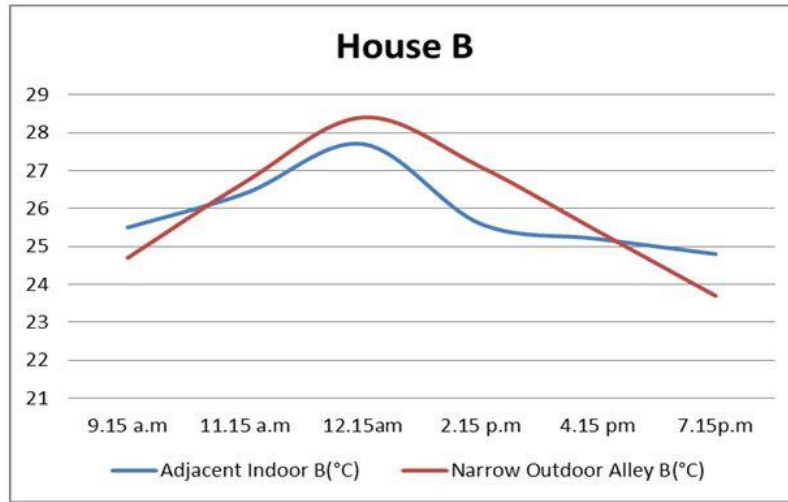

Table 02: Temporal Variations of the measured Air Temperature of House A and House B

HOUSE A 12, Rupchan Das Lane, Sutrapur.									
30.12.2017	temperature			Humidity			Airflow		
	Adjacent Indoor	Narrow Outdoor Alley	Transitional space	Adjacent Indoor	Narrow Outdoor Alley	Transitional space	Adjacent Indoor	Narrow Outdoor Alley	Transitional space
9.45 a.m	24.9	25.6	25.3	57%	50%	40%	0	0	0
11.15 a.m	23.8	25.6	25.1	71%	70%	59%	0	0	0.1
12.00am	25.1	27.5	26.5	46%	47%	55%	0	0	0
2.30 p.m	26.9	27.2	27.4	55%	54%	52%	0	0	0
4.10 pm	25.7	25.6	25.6	58%	57%	5600%	0	0.1	0
7.00 p.m	24.4	23.9	23.7	62%	60%	59%	0	0.6	0

Table 03: Temporal Variations of the measured Air Temperature, Relative Humidity and Airflow of House A and House B.

HOUSE B 9, Rupchan Das Lane, Sutrapur.									
30.12.2017	temperature			Humidity			Airflow		
	Adjacent Indoor	Narrow Outdoor Alley	Transitional space	Adjacent Indoor	Narrow Outdoor Alley	Transitional space	Adjacent Indoor	Narrow Outdoor Alley	Transitional space
9.45 a.m	25.5	24.7	N/A	61%	48%	N/A	0	1.1	N/A
11.15 a.m	26.4	26.7	N/A	58%	62%	N/A	0	0.1	N/A
12.00am	27.7	28.4	N/A	51%	55%	N/A	0	0.3	N/A
2.30 p.m	25.6	27.1	N/A	54%	55%	N/A	0	0.1	N/A
4.10 pm	25.2	25.4	N/A	57%	56%	N/A	0	0.1	N/A
7.00 p.m	24.8	23.7	N/A	60%	58%	N/A	0	0.5	N/A

Table 04: Temporal Variations of the measured Air Temperature, Relative Humidity and Airflow of House B and House B

5.2 COMPARATIVE ANALYSIS BETWEEN HOUSE C AND HOUSE D

The narrow outdoor alley temperature at the starting time of temperature measurement in House C and D is 23.8°C and 24.6°C respectively (Table 06, Table 07), it is relatively lower comparing with the scenario of Outdoor temperature in front of House A and House B. It is may be due to the rooms orientation towards north and having no sun exposure. The outdoor temperature rises at its peak at around 12.00 pm and continue till 1.00 pm; it starts to fall from around 1.30 pm and a gradual temperature reduction can be seen towards evening around 7.15 pm. The Temperature in transitional

space of House C changes and follows the curve of outdoor temperature, having its peak temperature around 1.00 pm and then tends to fall with the fall of outdoor temperature (Table 05). Similar to the scenario of House A and B, a significant difference can be seen in the measured temperature of indoor. The indoor temperature poorly follow the curve of the temperature of outdoor. In House C, the indoor temperature rises its peak at around 2.30 pm , it can be caused due to the buffer zone of transitional space (Table 05). The transitional space or the thresholds helps to delayed indoor heating by providing shadow zone and eliminating heat radiation, conduction and convection directly. But in House D , a difference can be identified that the outdoor temperature remains lower from morning to noon till 1.30 pm , it can be caused by a local airflow possibly resulted from the configuration of narrow alley. From noon the outdoor temperature rises till 2.30 pm and tends to low than indoor from evening around 4.10 pm. The same scenario after evening is also found in this case like the case of House A. The indoor air temperature continues to be higher than the outdoor temperature in House C as an effect of the heat trap due the transitional space and here the temperature is significantly higher than the indoor temperature of House D (Table 05). So it can also be concluded here that transitional space help in postponing heating in indoor temperature at day time, but from evening to night, it kind of traps the heat from distributing outside by creating a buffer and performs as a hollow thermal mass which suspends the process of heat dissipation from indoor.

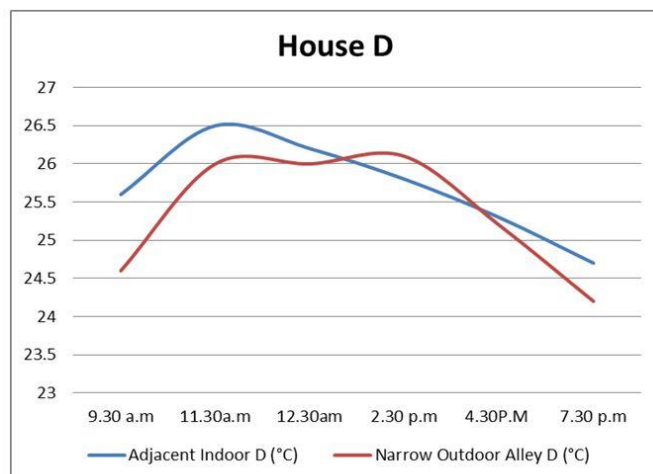
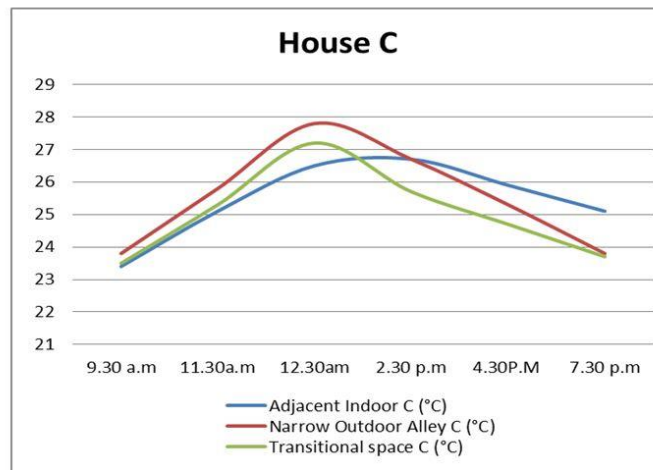

Table 05: Temporal Variations of the measured Air Temperature of House C and House D

HOUSE C 56, Rupchan Das Lane, Sutrapur.									
30.12.2017	temperature			Humidity			Airflow		
	Adjacent Indoor	Narrow Outdoor Alley	Transitional space	Adjacent Indoor	Narrow Outdoor Alley	Transitional space	Adjacent Indoor	Narrow Outdoor Alley	Transitional space
9.45 a.m	23.4	23.8	23.5	57%	50%	40%	0	0.4	0.1
11.15 a.m	25.1	25.8	25.3	60%	54%	59%	0	0	0
12.00am	26.5	27.8	27.2	53%	55%	55%	0	0.1	0
2.30 p.m	26.7	26.7	25.7	53%	53%	52%	0	0	0
4.10 P.M	25.7	25.3	24.7	56%	55%	56%	0	0.1	0.1
7.00 p.m	24.6	23.8	23.7	58%	57%	59%	0	0.3	0.2

Table 06: Temporal Variations of the measured Air Temperature, Relative Humidity and Airflow of House C

HOUSE D 59, Rupchan Das Lane, Sutrapur.									
30.12.2017	temperature			Humidity			Airflow		
	Adjacent Indoor	Narrow Outdoor Alley	Transitional space	Adjacent Indoor	Narrow Outdoor Alley	Transitional space	Adjacent Indoor	Narrow Outdoor Alley	Transitional space
9.45 a.m	25.6	24.6	N/A	65%	51%	N/A	0	0	N/A
11.15 a.m	26.5	26	N/A	57%	59%	N/A	0	0.1	N/A
12.00am	26.2	25.1	N/A	67%	64%	N/A	0	0	N/A
2.30 p.m	25.8	26.1	N/A	55%	55%	N/A	0	0	N/A
4.10 pm	25.3	25.2	N/A	58%	56%	N/A	0	0	N/A
7.00 p.m	24.7	24.2	N/A	56%	57%	N/A	0	0.4	N/A

Table 07: Temporal Variations of the measured Air Temperature, Relative Humidity and Airflow of House D

5.3 COMPARATIVE ANALYSIS BETWEEN HOUSE A AND HOUSE C

It can be seen in both House A and C in which the adjacent room with transitional space possesses lower indoor temperature than outdoor at daytime. The indoor temperature remains significantly reduced than outdoor and there remains a time gap of almost 2-3 hours in between the peak of maximum outdoor temperature and maximum indoor temperature, which indicates a significant delay in the process of heat gain through radiation, conduction and convection. In both cases towards evening the indoor temperature rises and become higher than the outdoor temperature, which indicates that the transitional space helps to confined the heat in indoor rather quickly remove it. This transitional space possibly act like a hollow thermal mass which hinder in quick reduction of indoor temperature by trapping heat inwards (Figure 07, Figure 08). In both cases outdoor temperature and the temperature of transitional space tends to fall down towards the time of evening, but indoor temperature remains steady and reduces very slowly comparative to the outdoor and transitional space temperature

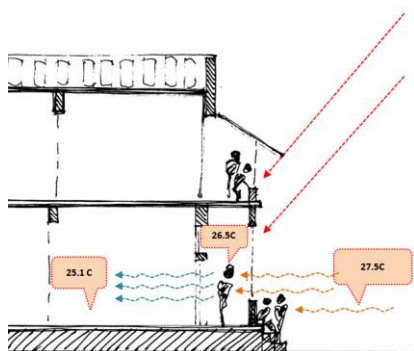

Figure 07: conceptual section of House A (Room towards south)

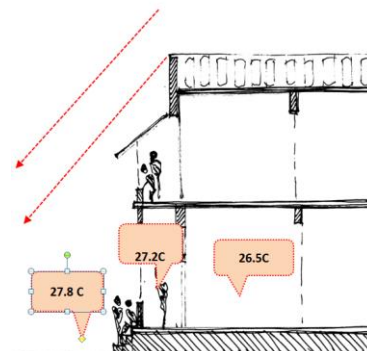

Figure 08: conceptual section of House C (Room towards North)

5.4 SUMMERY

Comparing the temperature of day time at peak outdoor temperature, it can be seen that House A performs better than other three houses (Table 08), the temperature difference between outdoor and indoor is 2.4°C (positive) which indicates a sufficient reduction in indoor heat, causing by the transitional space; whereas the temperature difference is only 0.7°C between indoor and outdoor of House B at same time at same direction.

Comparing the temperature of night-time, at around 7.00 pm, it can be identified that House A and House D performs better than House B and C (Table 09). The negative temperature value indicates a rise in indoor temperature than outdoor. House C and B with transitional space have larger negative value, but a possible airflow (Table 03) in outdoor and transitional space (0.6 and 0.4 respectively) probably increase heat dissipation by moving the stuck heat from transitional space and allowing heat exchange from indoor to transitional space then finally towards outdoor.

	Day time	Adjacent Indoor	Narrow Outdoor Alley	Transitional space	Temperature Difference	
HOUSE C	12.00pm	26.5	27.8	27.2	1.3	
HOUSE A	12.00pm	25.1	27.5	26.5	2.4	Performing BEST
HOUSE D	2.30 p.m	25.8	26.1	N/A	0.3	
HOUSE B	12.00am	27.7	28.4	N/A	0.7	

Table 08: Comparative analysis of temperature at peak outdoor temperature (Day time)

	Night time	Adjacent Indoor	Narrow Outdoor Aley	Transtional space	Temperature Difference	
HOUSE C	7.00 pm	24.6	23.8	23.7	-0.8	
HOUSE A	7.00 pm	24.4	23.9	23.7	-0.5	Performing BEST
HOUSE D	7.00 p.m	24.7	24.2	N/A	-0.5	Performing BEST
HOUSE B	7.00 p.m	24.8	23.7	N/A	-1.1	

Table 09: Comparative analysis of temperature at peak outdoor temperature (Night time)

6. Conclusion

This paper indicates that the transitional space of traditional row houses not only act as a space for social interaction but also contributes in achieving thermal comfort of the users, varying with time. Results from the study reveal a correlation between thermal comfort conditions and configuration of traditional row house. Transitional spaces contribute in delaying heating up process at day time but the indoor temperature tends to be confined due to the buffer created by transitional spaces at night time. It also reveals that with a good airflow and exposed towards south, the adjacent room can performs better even at night time. These conclusions have implications on climate design. Thus, the use of transitional spaces for passive cooling in tropical climates is possible by effective building design. Further research for other climatic extremes would be useful.

7. Acknowledgements

This paper is developed as a workshop term paper under M.Arch program of Bangladesh University of Engineering and Technology for Thermal Environment and Built Form (ARCH 6101) course and course Tutor is Atiqur Rahman, Assistant Professor, Department of Architecture, BUET.

8. References

- Brownstoner.com <https://www.brownstoner.com/architecture/what-is-a-row-house-brooklyn-townhouse-architecture-history/>
- Wikipedia Encyclopedia, "Dhaka CLimate". Available: [https://en.wikipedia.org/wiki/Climate_of_Dhaka]
- Weatherbase.com "[Weatherbase: Historical Weather for Dhaka, Bangladesh](#)" Retrieved 2008-12-15.
- Zakariaa M. A., Kubotaa T. and Toe D.H.C 2015, *The Effects of Courtyards on Indoor Thermal Conditions of Chinese Shophouse in Malacca* Procedia Engineering 121, Pp. 468-476.
- Rajapaksha, Indrika & Nagai, Hisaya & Okumiya 2002, *Indoor airflow behavior and thermal comfort in a courtyard house in warm humid tropics*. Proceedings: Indoor Air 2002, Masaya
- Kubota T., Toe D.H.C and Ossen D. R. 2014, *Field Investigation of Indoor Thermal Environments in Traditional Chinese Shop houses with Courtyards in Malacca Malaysia, using field measurements and focuses on the cooling effects of courtyards*, Journal of Asian Architecture and Building Engineering, Pp. 247-254.
- Toe D.H.C and Kubota T. 2015, *Comparative assessment of vernacular passive cooling tech-niques for improving indoor thermal comfort of modern terraced houses in hot-humid cli-mate of Malaysia*, Sol Energy, Pp. 229-258.
- Tariq S.H. and Jinia M.A. 2013, *Performance of Fixed Horizontal Shading Devices in South Facing Residential Buildings in Dhaka*, Global Science and Technology Journal, Vol. 1. ,No. 1.Issue, Pp.88-99
- Oliver P. 2006, *Built to Meet Needs: Cultural Issues in Vernacular Architecture*, Architecture Press, Oxford.

Samarawickrama, Sumanthri, et al (eds), 2018, "Sustainability for people - envisaging multi disciplinary solution": *Proceedings of the 11th International Conference of Faculty of Architecture Research Unit (FARU), University of Moratuwa, Sri Lanka, December 08, 2018 Galle* pp. 431-439. ©

SINHALA TRADITIONAL MUSIC OF SRI LANKA FOR STRESS RELIEF: AN INTERACTION DESIGN INTERVENTION

SAMANGI WADINAMBI ARACHCHI¹ & SUMANTHRI SAMARAWICKRAMA²

Department of Integrated Design, University of Moratuwa, Sri Lanka.

¹samangi19@gmail.com, ²sumanthri.s@gmail.com

Abstract

Stress is one of the utmost heard words in today's world. Developing unnecessary stress over a prolonged time could become chronic. With this fast pace, the time has become a decisive factor in each one's life. Thus, people spare less time engaging in relaxation activities. They seek out for alternative ways such as using mobile apps which adopt different modes of relaxation.

When focusing into the local context, Sinhala traditional music of Sri Lanka was one of the most used modes of relaxation for the people in the past. Now it is rarely practiced. In the pilot study revealed that Sri Lankan traditional modes of relaxation are not present among the developed mobile apps and HCI based interactions for stress relief.

Therefore, this study was aimed to fill the gap between existing HCI (Human-Computer Interaction) based stress relief modes and the application of Sri Lankan Traditional Knowledge which is fast fading. Investigating the possibilities of adapting Sinhala Traditional Music of Sri Lanka into HCI application was the primary aim of this study.

Objectives of the research were acquired by following a mixed method approach. To select the subjects for the study convenience sampling method was used. In phase one of the experimental studies, it revealed that relaxation response towards Sinhala traditional music was high compared to other proven relaxation music modes. The possibilities of using emotional Inputs that could be fed into an Interactive system design was observed in the in-depth experimental study. This attempt, forecasted potential areas to be researched further. Also, further study should be done to validate whether these findings can be generalized which was not concerned in this study. Moreover, this study could be extended to develop an affective and emotional interaction design that could facilitate young adults of Sri Lanka.

Keywords: *Sinhala Traditional Music of Sri Lanka, Stress Relief, Human Computer Interaction, Mobile Health Apps*

1. Introduction

This paper speaks of a study which focused on understanding how a Sri Lankan young adult would expect to relief their daily stress using HCI. This study investigated the possibilities of adapting Sinhala Traditional Music of Sri Lanka into an HCI design.

1.1. BACKGROUND AND CONTEXT

Music itself is a mode of relaxation, At the root of all these reasons lies the fact that music links with our innermost emotional, spiritual and private selves. Music helps us to feel more Human." (Bunt, 1994) When converging this idea into the local context, it is understood that Sinhala traditional music of Sri Lanka has been one of the most used modes of relaxation of the people who lived in the past. Yet, it is barely heard today. (Beddage, 2005).

A few decades away the life of a Sri Lankan was born to the tune of Sinhala traditional music. While resting on mother's womb they started to get engaged in this profound system by hearing *Angulimala Piritha* even before they see the light of the world. Once born, the tune of their mothers enlightened them with *Nelavili Gee* (Sinhala lullabies), when these children started to play, their entertainment was enriched with Kavi associated with *Eluwan keama*, *Olinda Keliya* (Folk games) and so on...As they become adults, while they work, they sang *Goyam Kavi* (Harvesting songs), *Pel Kavi* (Watch-hut Songs)

, *Kamath Kavi* (Harvesting Song) to make them feel relaxed amidst their physical tiredness. *Pirith* chanting and *Gatha* chanting was a part of their daily routine. When they feel diseased, they seek the help of *Bali*, *Thovil*, and *Shanthikarma* (Types of folk rituals of Sri Lanka) as a mode of cure. Once they exhale their last breath people around kept in mind to chant *Pirith* (Buddhist chantings). *Welapum Kavi* (Lamentations) was sung next, to ease the pain of the loss of the loved one at the funerals back then.

Throughout their lives, people have had a profound relationship with music irrespective of the literacy they have had (Beddage, 2005) When conversed with people two or more generations back, they say they scarcely experienced and heard the word stress or in Sinhala if we say *Aathathiya* (Stress).

When taking a look at the age we pass, the word "stress" is one of the utmost heard words in someone's life. As university students, we fall into the category of young adults. It is a period of transition in our lives. Irrespective of the gender, (Kuruppuarachchi, Kuruppuarachchi, Wijerathne, & Williams, 2001) starting to live by ourselves away from home, academic workload, examinations, problems with interpersonal relationships are some of the stressors we meet at this stage.

Stress might be a necessary factor to some extent to keep ourselves motivated, and in an alert. Yet unnecessary stress over a prolonged time could become chronic — unless we take action. (American Psychological Association, 2018) Researches have revealed that chronic stress may cause negative thoughts, lead to diseases like depression and al-so higher cardiovascular risk.

Apart from this fact, it is identified that there's a rise in the stress levels of young adults. These young adults are found to be the most stressed-out generation. (Sifferlin, 2013) If this active work-force gets exposed to chronic stress disorders, their performance could be less. (American Psychological Association, 2018) Thus, it is evident that young adults should keep an eye on their physical and mental wellbeing.

To cope up with stress people used different modes since past. Amongst Meditation, Aroma Therapy, Massaging, Listening to Music, reading books are some of the practices people have embraced. People had time to get engaged and to experience the effects of these techniques in the times back then.

However, now the world is in a rat race, and time has become a decisive factor in each one's life. Thus, people spare less time engaging in these leisurely activities to calm and to make themselves de-stressed. They seek out for alternative ways to make them feel relaxed. When these alternative methods are considered, Mobile applications play a significant role.

When looked at in a bird's eye view, it is seen that most of the youngsters of the world tend to get hooked on their mobile phones. (Brody, 2017) This cause will also in return increase their level of stress unconsciously.

Even though the negative impacts of this interaction exist, it is seen that Mobile applications are used to reduce stress. When observed these apps adapt different conventional modes of relaxation. These apps are comprised of lessons, tutorials, and informative/virtual instructions. (Ewais & Alluhaidan, 2015)

In order to understand whether there's a presence of Sinhala traditional Music in the space of mobile applications for stress relief, a content analysis was conducted as a pilot study which focused on identifying the existing modes of application of HCI in stress reduction and their characteristics, their features and their objectives. With the findings of the pilot study, it was understood that amidst developed mobile applications the use of Sinhala traditional music of Sri Lanka unseen.

1.2. AIMS AND OBJECTIVES OF THE STUDY

Standing on the above stated background and the context, this study investigated the possibilities of adapting Sinhala Traditional Music of Sri Lanka into an HCI design. In order to achieve the above stated aim, following core objectives were achieved in the study,

- Identifying what is Sinhala Traditional Music of Sri Lanka and its effect on stress reduction in comparison with other therapeutic modes of music used in Stress Reduction.
- Investigation of the possibility of adapting Sinhala Traditional Music of Sri Lanka into an Interaction design for stress reduction among young adults.

1.3. THE SIGNIFICANCE OF THE STUDY

The results of the study forecasted the potential ways of adapting Traditional knowledge of Sri Lankan music used in stress reduction to benefit the young adults of the modern day through their most engaged interaction; mobile and smart devices. At the same time, the study may pave the way to restore the fast disappearing traditional knowledge entwined with the Sri Lankan culture as it is fused with modern technology.

1.4. HYPOTHESIS

Sinhala traditional music for stress relief can be adapted into an interaction design for stress reduction in the similar manner of other music already adapted into musical interaction for stress reduction.

1.5. SCOPE AND LIMITATIONS OF STUDY

This study was focused on Jana Kavi with particular reference to Nelavili Gee (Sri Lankan traditional lullaby's), due to time constraints and as well as its melodic structure which could be readily understood by an individual irrespective of their musical knowledge.

Furthermore, technological barriers were met when using Sinhala traditional music on a digital device. Additionally, in the phase of the experimental studies, the study was conducted within less technically advanced space and devices thus a considerable error rate should be expected in the findings.

2. Methodology

In order to implement, this study was conducted as exploratory research. Where it involves both quantitative and qualitative approaches.

The population of this research is Young adults of Sri Lanka. Auditory impaired or incapacitated participants were disregarded in this study.

Following denotes the phases of the study in achieving the main objectives of the study.

2.1. UNDERSTANDING THE SAMPLE CONSIDERING THEIR LEVEL OF STRESS, EXISTING MODES OF RE-LAXATION, THEIR MUSICAL PREFERENCES AND ENGAGEMENT WITH MODERN TECHNOLOGY AS A MODE OF RELAXATION.

2.1.1. Sample

By convenience sampling method, the sample (n=52) was selected from Level I students of the Department of Integrated Design, Faculty of Architecture, University of Moratuwa. Age: between 18 – 25 years.

Due to several reasons only (n=48) questionnaires could be collected and took forward for the process of analysis. Amongst (n=47) questionnaires were accepted and one questionnaire was disregarded under the parameter incomplete.

2.1.2. Data Collection Method

In order to have an overview of the level of stress, Perceived Stress Scale (PSS) Scale along with a questionnaire prepared by the author was used as data collection instruments. (State of New Hampshire Employee Assistance Program, 2014)

2.2. UNDERSTANDING THE SAMPLES REACTION TO DIFFERENT TYPES OF MUSIC USED FOR RELAXATION BY CONDUCTING EXPERIMENTAL STUDY 01.

One day after the questionnaire was distributed, the sample was called for the Experimental study I. Which was conducted in a controlled environment as explained below.

2.2.1. Environmental factors

The context selected was a closed room where the temperature was maintained at 23°C. While listening to music the room was maintained dark by switching off lights, to reduce the visual stimuli while listening to music. The walls of the room were padded and painted black. Thus, echo was minimized.



Figure 56 Environment of the Experiment 01

25 subjects (N=25) among the sample participated in the experimental study 01.

2.2.2. Music pieces used for the experimental study

Following music pieces were used to conduct the experimental study. The sequence of the arrangement of the tracks was based on context which it has been derived i.e., starting from the global context, then to regional context, and then to the local context.

Table 27 Music pieces used to conduct the experimental study

Weightless by Marconi Union ;	Weightless is considered as the most relaxing song (Passman, 2016)
Raag. <i>Puriya Dhaneshri</i> by Pt. Pannalal Gosh played with Bansuri	It is a Sandhi Prakash raga which says to bring the best results when played in the evening. This raga is considered to be one of the most relaxing North Indian Hindustani Ragas
Playing the notes C D E F G By the author using a keyboard	C D E F G notes are the notes used in <i>Awadarana Sanyuthi</i> in Sinhala Nada system. These are the most prominent notes used in generating <i>Karuna</i> and <i>Sringara</i> rasa. (Beddage, 2005)
<i>Nelavili gee</i> instrumental –	Sinhala lullaby
<i>Karaneeya Metta Sutraya</i>	Sinhala chanting of <i>Pirith</i>
<i>Raire O Rama</i>	Kamath Hella recording by C.De.S. Kulathilake

2.2.3. Data collection instruments

In this experimental study the data was collected by measuring the heartrate of the user and through their reflection sheets.

Heart rate was measured using an Electronic Blood pressure meter and a mobile app called Instant Heart Rate: HR Monitor & Pulse Checker developed by Azumio Inc. Where the user is asked to keep their finger on the mobile camera.



Figure 57 Left: electronic blood pressure meter Right: using Instant heart rate app

2.2.4. The process of the Experimental study 01

To conduct the experimental study, following steps were followed.

Step 01: Heart rate of the sample was measured.

Step 02: The subjects were advised to stay in a relaxed position they like for example, sit, stand, lean on the floor etc. and was kept in complete silence and dark for two minutes, followed by an interval (a resting time) of eight minutes.

During the resting time the subjects were advised to write down what they felt and to draw their expression of the experience. Furthermore, their heart rate was measured.

Step 03: The sample was exposed to music listed above. All of these music tracks were played for 2minutes accompanied by an interval of 10minutes at a medium (80db) sound intensity level.

2.3. CONDUCTING THE IN-DEPTH STUDY AS TO REVALIDATE THE PREVIOUS FINDINGS AND ALSO TO IDENTIFY THE OPPORTUNITY TO OF POTENTIAL INPUTS THAT COULD BE GIVEN IN TO AN HCI BASED SYSTEM TO UNDERSTAND THE STATE OF STRESS.

To perform this in-depth study using criterion sampling eight subjects (n=8) were selected. The criterion behind their selection was the musical preference and the level of stress category they belonged to.

2.3.1. Environmental conditions

Similar to the previous experiment this study was performed in a studio which is sound proof and where blackout condition could be brought in easily. the temperature was maintained at 23°C. The walls of the room were padded and painted black. Thus, echo was minimized. The lighting condition of the room was maintained at a calming twilight condition (10.8lux), As night-vision cameras were not available for the study to capture facial expressions in a pitch-dark condition.



Figure 58 Environment conditions in In-depth Experiment

Main aim of this arrangement was to minimize sensory stimuli except auditory stimuli. Following table denotes the conditions that was expected to be kept constant.

Table 28 Conditions that were kept constant for the in-depth study

Sensory organ	Stimulus	Restrictions maintained
Eye	Light	lighting condition of the room was maintained at a calming twilight condition (10.8lux) as light is a necessary factor to capture images through a DSLR camera
Nose	Smell	No air fresheners or perfumes were permitted
Mouth	Taste	Subjects were advised not to eat anything within 1h time before the experiment.
Touch	Temperature	The temperature of the environment was kept at 23OC as it is considered to be the most comfortable temperature condition

2.3.2. The process of the in-depth study

Similar to the previous experiment to conduct the experimental study, following steps were followed. But the music pieces used was limited to 3. The sample was exposed to music titled “Weightless” followed by *Raag Puriya Dhaneshree.*, *Nelavili gee* (Sri Lankan traditional lullaby’s), All of these music tracks were played for 2minutes accompanied by an interval of 10minutes at a medium (80db) sound intensity level.

2.3.3. Data Collection

The data of this experiment was collected by means of reflections of the sub-jects, their heart rate before and after listening to music, brainwaves determining the brain state while listening to music, and facial expressions to determine the change of their emotions.

Table 29 Devices and instruments used to collect above stated data

Collected Data	Instrument/ Device	What is to be analysed
Reflections	Questionnaire	Thoughts and expressions of the subjects
Heart rate	Instant Heart rate app/ The results were validated using electronic pressure meter	Relaxation response
Brainwaves	Emotiv device	The brain states while listening to Music
Facial Expressions	Video sequence captured with DSLR camera- Canon 5D- Mark II And processed using Emotion API Microsoft Azure	Identifying emotional changes while listening to music

3. Findings

After analysing the results of the perceived stress scale of (n=47) the following results were obtained. 72% (34/47) of the sample was classified as moderate stressed and 19% (9/47) were classified as low stressed and 9% (4/47) of the sample was reported as high stressed.

When existing modes of relaxation used by the sample was considered, the most common mode of relaxation among the sample is listening, playing and singing.

When samples attitude towards Sinhala traditional music for stress relief, 93.8% (45/48) expressed that they like to listen to Sinhala Music. 72.9% (35/48) liked Sinhala Traditional Music. Amongst overall sample only 85.4% (41/48) believed that Sinhala Traditional Music has been used as a mode of stress relief by the past generations.



Figure 59 Word-cloud representation of existing modes of relaxation of the sample

Furthermore, when the technological engagement of the sample was considered 100% (48/48) declared that they use smartphones. Midst, their most used device for relaxation was also found to be the smartphone.

As the next step of the study, subjects were clustered into 6 groups according to the information provided by the subjects in their questionnaires. Among these subjects (n=47) all were accepted to participate in the experimental study O1, which aimed to identify the impact of Sinhala Traditional Music for Stress reduction.

3.1. FINDINGS OF THE EXPERIMENTAL STUDY O1

For the Experimental study O1 only (n=25) was gathered. As explained in the previous section their heart rate and reflections were recorded. Analysis of the reflections denotes that phrases such as Relaxation, recalling, happy and warm appeared to be more prominent in *Nelavili Gee* than to other music pieces used.

Then a focused group discussion was conducted in Sinhala language for the convenience of the sample. It was felt that the sample was genuinely expressing their ideas from their mother tongue. The responses of this discussion, it confirmed that the subjects have had an impact from *Nelavili Gee* in relaxation response.

3.2. FINDINGS OF THE IN-DEPTH STUDY



Similarly, as the previous experiment the heartrate variation when listening to music was determined by comparing the heartrate records before and after listening to music.

Table 30 Findings of the in-depth study

"Weightless"	"Raag Puriya Dhaneshree"	"Nelavili Gee"
<p>This graph indicates that 62.5% (5/8) has lowered their heart rate.</p>	<p>Above graph indicates that 37.5% (3/8) has reduced their heart rate.</p>	<p>As the above graph, 87.5% (7/8) of the samples heart rate was reduced.</p>

Therefore, comparing above results, it could confirm that the ability for is greater in *Nelavili Gee* than other pieces of music used in the study.

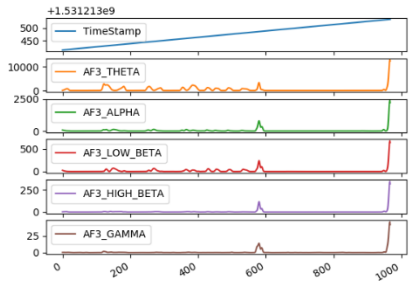
Table 31 Analysis of brainwaves and facial expressions

Analysis Brainwaves	Analysis of Facial Expressions
<p>To analyses average bands of the brainwaves were calculated and plotted as a bar graph which could be easily understood by anyone. Therefore, a program was written to plot the brain waves.</p>	<p>Earlier it was planned to analyze the facial expressions manually with reference to the <i>bhava</i> and <i>Navanalu Rasa</i>. With the time constraints it was difficult to analyze it as planned. Therefore, an emotion recognition algorithm; Emotion API developed by Microsoft was used to analyse emotions of the facial expressions. (Microsoft, 2018)</p>
	

4. Conclusion

By this study, it was determined that only the Heart Rate capturing through mobile camera has the capability of getting a reasonably accurate input. Signals detected by the Emotiv device (Industrially used EEG signal detection Brain-Computer Interfacing device) resulted in different results than the results obtained by the heart-rate analysis. It was understood that the noise of the detected brainwave signals was high; thus, accurate readings of the brainwaves is hardly achieved. Due to time constraints and technological limitations only one emotion recognition algorithm developed by Microsoft was used to analyze the facial expressions of the subjects. The results of facial expression analysis were contradictory with the textual and visual feedback given by the subjects. Thus, in this case, the accuracy of using image processing as an input mode for an interactive system to determine the emotion of the users was identified to be problematic since emotions detected by the computer did not match with the reflections of the sample. It was assumed that it might be due to the differences in facial expressions of humans from western and eastern contexts therefore further research to be done to identify the real cause behind this result.

With the findings of the in-depth experimental study it proved that 87.5% (7/8) of the sample's heart rate was reduced when listening to *Nelavili Gee*. Thus, *Nelavili Gee* has the ability to become an important asset in developing a context-based interaction design with traditional knowledge entwined.

Hence, it could be concluded that this research study disclosed the abilities to use Sinhala Traditional Music for stress relief via HCI which proved the hypothesis to be correct. Further research should be performed to validate whether the results of the study could be generalized.

5. References

- Deloitte Touche Tohmatsu Limited Global Brand & Communications, 2014. *The Deloitte Millennial Survey – Executive summary*, s.l.: DTTL Global Brand & Communications.
- American Psychological Association, 2018. *How stress affects your*. [Online] Available at: <http://www.apa.org/helpcenter/stress.aspx>
- Baron, R. A., 2001. *Psychology Fifth Edition*. New Delhi: Prentice-Hall of India Private Limited.
- Beddage, R., 2005. *Sinhala sangeetha shailaya*. Colombo : State Printing Cooperation.
- Brody, J. E., 2017. *PERSONAL HEALTH; Hooked on Our Smartphones*. [Online] Available at: <https://www.nytimes.com/2017/01/09/well/live/hooked-on-our-smartphones.html>
- Bunt, L., 1994. *Music Therapy: An art beyond words*. London, UK: Routledge.

Ewais, S. & Alluhaidan, A., 2015. *Classification of stress management mHealth apps based on octalysis framework*. Puerto Rico, s.n.

Kurupparachchi, K. A. L. A., Kurupparachchi, K. A. J. M., Wijerathne, S. & Williams, S. S., 2001. Psychological distress among students from five universities in Sri Lanka. *Ceylon Medical Journal*, 47(1), pp. 13-15.

Passman, J., 2016. *The World's Most Relaxing Song*. [Online] Available at: <https://www.forbes.com/sites/jordanpassman/2016/11/23/the-worlds-most-relaxing-song/#550b26fe2053>

Sifferlin, A., 2013. *The Most Stressed-Out Generation? Young Adults*. [Online] Available at: <http://healthland.time.com/2013/02/07/the-most-stressed-out-generation-young-adults/>

State of New Hampshire Employee Assistance Program, 2014. *Perceived Stress Scale*. [Online] Available at: <https://das.nh.gov/wellness/docs/percieved%20stress%20scale.pdf>

Yapa, 2018. *Stress and older generation of Sri Lanka* [Interview] (22 May 2018).

Samarawickrama, Sumanthri, et al (eds), 2018, "Sustainability for people - envisaging multi disciplinary solution": *Proceedings of the 11th International Conference of Faculty of Architecture Research Unit (FARU), University of Moratuwa, Sri Lanka, December 08, 2018* Galle pp. 440-447 ©

NON-VERBAL COMMUNICATIVE ASPECTS OF VERANDAH IN "WALAUWA" UNDER UVA PROVINCE: A CASE STUDY

MENDIS M. S., JAYASIGNHE S.

Department of Integrated Design, University of Moratuwa, Sri Lanka
malsharesearch@gmail.com

Abstract

Vernacular architectural built environments are bio climatically comfortable, effective spaces as means of achieving comfort. "Pila" is a sustainably designed built environment with a goal of long term sensitive humanization of vernacular Architecture. Together it merges natural environmental conditions such as natural light, heat and ventilation in a significant manner. This multidisciplinary sustainable built environment; "Pila", was introduced in the novel mode with the colonization known as "Verandah". Caste system declared during Kandyan period, society composed with groups of people comprising diverse social levels. Under this norms, upper class or elites' constructed a dwelling type "Walauwa". Verandah is the preliminary element that these diverse social structure met. The fixed and semi fixed elements acts as an immediate transitional communicating non-verbally and logically. Uva province faced two Kandyan wars. Three case studies prevailed in Uva belongs to Last colonized British period creates an opportunity to interpret and compare the Verandah periodically. Detailing, materials, proportions and the user behavior was studied in depth on semi fixed elements of the Verandah and analyzed. The study will analytically conclude, how the semi-fixed elements, in depth towards furniture in Verandah non-verbally communicates the prevailed social structure with respect to Uva province.

Keywords: *Pila, Walauwa, Verandah, semi fixed elements, Communicative aspects*

1. Introduction

Kandyan period was the last independent monarchy of the island of Sri-Lanka. Caste system was introduced to the society during this period, creating a hierarchical order as High caste who interpreted themselves as the elites, service caste, and the lower caste. Each caste conveyed different sets of identical characters. To symbolize the social status, economic power position in the social structure. High caste or the elites constructed an advanced ornamental living place named 'Walauwa'. The utilization of 'Walauwa' was a medium of dwelling and place of displaying their social status. The highest elevation of the site was selected to the construction to symbolize the position given to the chief resident in the society. The owner of the 'Walauwa' had the authority to pass judgment over the people through the authorities given by the royal announcement. So people in different social classes gathered in this context. One of the characteristic element of 'Walauwa' was Verandah. It is more exposed to nature.

According to the traditional architecture in Sri Lanka, Verandah is the first built experience of a house. The communication was done nonverbally, using structural, material and behavioral patterns. This space creates the first impression and an immediate transitional built space. This element had been influenced with the arrival of the three colonials as follow,

(Kelegama S, Madawela Editor, 2002, pg 401) Portuguese was the first nation started colonizing Sri Lanka had a chance in arriving the country from Galle. (1505 to 1658). Portuguese colonization influenced mainly the culture, architecture and the religions in Sri Lanka. Then the Dutch who established in 1658 created a great impact towards the Sri Lankan society. The caste systems were not destroyed by the Dutch but they modified the caste system prevailed in Sri Lanka. The British social structure started distributing their powers around 1796. The powers of these elites were assigned for

their personal achievements. The caste system or the kingships were started diverging. Finally in 1815 the power of English was established in the whole country.

Simultaneously, Society changed in the meantime architecture was influenced, Elements were modified. Some were newly introduced. Verandah was, an element introduced by the Portuguese as a modification of traditional 'Pila' in a novel mode. It achieved different moods after Dutch and British periods. When considering the Verandah in 'Walauwa' context; it was the place where owner of the 'Walauwa' from the higher society and outsiders from different social categories met together. (Brohier R.L., 1969) Colonials were main charters who introduced movable furniture to Ceylon. 'Walauwa' was a better context to study the non-verbal communication through the semi-fixed features such as furniture and furnishing. This study look forward on the semi fixed elements of the verandah communicate behavioral patterns and Hierarchy maintained by the society and study the Semi fixed features of Verandah acts as emblems that used in place of commutative elements. They contain various clues. By studying the layout, details, materials, motifs, clues that non-verbally communicated can be simply interpreted. To conclude, British ruled the Sri Lanka nearly two hundred years and involved in socio-economic, cultural, architectural changes. These influences were still visible in hill country, Uva province 'Walauwa'. So there was a need of getting educated by studying historical remains. British influenced semi-fixed elements in Verandah was one of the fascinating broad subject which can be analytically studied under a wide array of areas and to achieve a wider knowledge in Verandah. Throughout this dissertation it signifies the non-verbal communication in semi fixed features (furniture and furnishings) of verandah.

2. Methods and methodology

This research is envisioned to study about semi-fixed features in it, and to analyse their involvement to communicate hierarchy and behaviours. Elite houses "Walauw" have been chosen, as the case studies where the semi fixed features of Verandah were well preserved to do a study in the original format. The details are mainly gathered from the archaeological departments and museums and field research. The information obtained were gathered from the discussions and observations made with the constant visits to these to Walauwa in UVA province. The study is limited to three protected 'Walauwa' in British period which locates in Uva province that was still functioning. Unique semi fixed elements in verandah found in the context were deeply researched. These three cases are studied deeply with the various aspect of the semi-fixed features such as materials, detailing, and proportion. Especially more priority was given on human interacting space and furniture.

3. Materials

First case study ;Dambawinna 'Walauwa' Walauwa located in Goonabaddha, Wellimada ,Uva province with a history runs back to 250 years back. The Structure of the Walauwa falls under 3 periods as Kandyan, Early British, and Late British. Initial origin of Dambawinna walauwa falls under Kandyan period. Second Case Study; Sanarakoon *Walauwa* situated in Puwakgodamulla, Badulla runs to nearly 125 years back. Now it is under the property of Mr. Milroie Rathwaththe as a 3rd generation property. According Milroie Ratwaththa, The *Walauwa* was constructed in the decade of 1880 s. Initially this was a property of former chieftain of Badulla namely belonged to *Rambukpotha* chieftain. Until his grandfather lived this Walauwa was known as *Samarakoon Walauwa*. Third Case Study; Katugaha Walauwa according to Dharmapala Attanayakes' readings, *Maligathanna* (Maliththa) ,Under Pattiyagedara postal division, Haliela this area comes with a great history.

4. Results and discussion

Among the above three case studies initially the layout was considered and then the furniture was assessed; Fig 1, Fig 2, Fig 3.

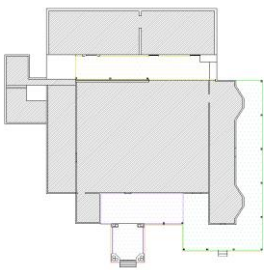

Fig 1- Plan of the Dambawinna Walauwa
Source - Author

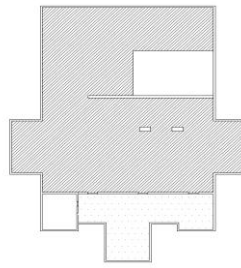

Fig 2- Plan of the Samarakoon Walauwa
Source Author

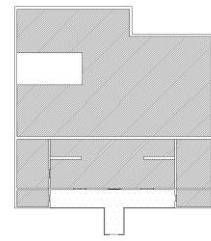

Fig 3- Plan of the Katugahagedara Walauwa,
Source – Author

4.1 Constructive material

Special mixture of clay and cow dung was used to finish the floors of the Verandah. Initial roofing materials of the Walauwa was ‘eluk’ and later on with the half round tiles. These depict that earlier the lives were bounden mostly with the nature. And the complicate functions but simple designs like motar and pestle communicate, how rich agriculturally fed families had been lived in the Walauwa. Proportion and the size helps to visually communicate it. The Indian influences on craftsmanship were not seen in this Verandah. Furniture was so simple. Using mats made the seating more comfortable and built up a hierarchy. Since this verandah was raised up nearly one foot up. The lower class people were not allowed on to this area but the ground level. Most of the agricultural equipment’s were seen on this verandah.

4.2 Verandah furniture layout

The veranda space describes the way how the furniture was arranged. As the space (a) has Mono design furniture (furniture out of rare material and Design) it communicates that this once even in the same verandah space (a) had a hierarchical level respective to space (b).

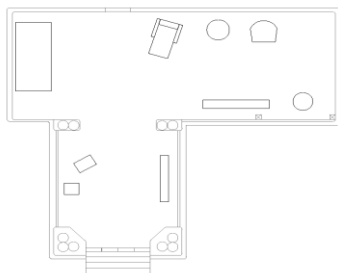

Fig 4 - Plan of the early British Verandah- Dambadeniya Walauwa, source author

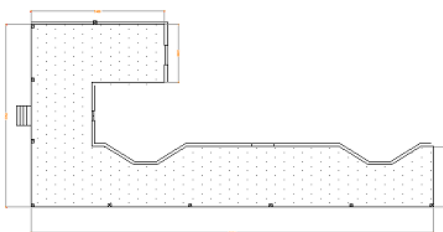

Fig 5 - Plan of the Late British Verandah- Dambadeniya Walauwa, source author

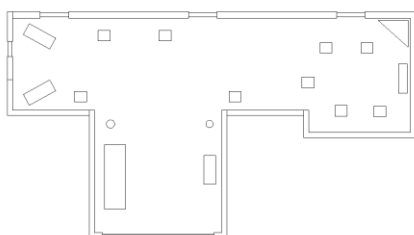

Fig 6 - Plan of the British Verandah-Samarakoon Walauwa, source

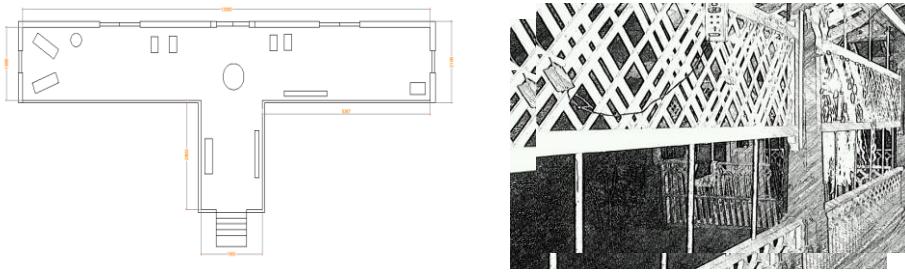

Fig 7 -Plan of the Late British Verandah- Katugahagedara Walauwa, Source author

4.3 Nonverbal Communication

Generally the communication among the people occur The furniture in this area had both Utilitarian function and Expressive Function. Fig 4,5,6,7 in three ways, Verbally, Vocally, Non Verbally. According to the suggestions of (Sarles.H, 1969), socio-conceptual characteristics of communication, that were of course, which were non-verbal and furthestmost important in the logic that they were the most immediate transitional, relatively indicate and they were the “loudest.” Mainly non-verbal communications are perceived visually. There two different ways that the concept of non-verbal communication can be defined in the surroundings, such analogy or metaphor. Nonverbal communication researches the links between different forms of communication have been studied by observing the cues or hints and then making interpretations. Since non-verbal analysis delivers a more beneficial model than does language.

4.3.1 Semi-fixed features in Verandah

The Verandah space provided with decorative set of semi fixed elements that utilize to entertain the outsiders as well as the owners. Furniture had played a main role in it. This was the master chair; Fig 8, used by the British ruler .Europeans has used Nadun timber as a valuable material to emphasize the hierarchical range. The seating posture had built the personality to communicate the status of the user ;fig 17. According to the observation of the below colonial furniture, standard proportions and sizes were used. Since that the height, width, length were standardized creating a double seating space for users; Fig 9. Rich carvings to enhance the social power and the prosperity. The details and aesthetic and the comfort ability of a furniture is the simplest social expressive elements that people could easily grab. Convertable stool ;fig 11, manufactured to the table height, out of nadun timber .Legs are detailed using the lath machine and two legs acts as a single unit that rotated around the centre axis so that the legs are simply foldable. It provided a writing surface at the top to the ruler to sign documents and stuff, and also to keep documents. The *kanappuwa*; Fig 10 made of Ebony timber, popular material for furniture among the Europeans. Varieties of timber gained with different values and prices also emphasize the hierarchical range. Designer has not bothered regarding the details. Because hierarchical value was already through the material. It communicates the pride of the user. “Feeding Chair” ; Fig 12 was made of Nadun 1100x 560x350 mm in size, 90 °in angle. It was unique among the breast feeding mothers. Since this doesn’t have two arm rests it created a perfect seating posture to the mother to feed the child. The proportion of the chair was harmless to the comfort of the child; fig 18. As there were no barriers the child is free to move his body .So it creates a relief to the mother & the child doesn’t get hurt when feeding. The proportion and the size of the furniture were well planned for relaxing purpose also made of Nadun Timber. This conveys the message to the user to relax fig13. The design seems simple and optimum functioning. 900(T.H) x 540x310 mm in size, 90 °in angle. Similar design to the early British feeding chair .Though the pattern of the chair was similar the proportion and the size had been changed; fig 16 .This depict the facts of the prevailed Society And through the observation it clearly convey two generation.

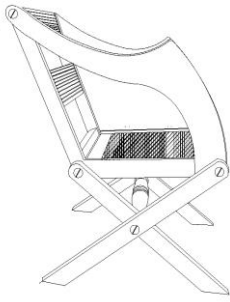

Fig 8 – Master chair
Dambawinna Walauwa
Source- Author

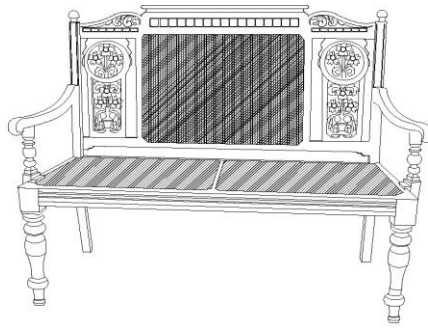

Fig 9 - Two Seater
Dambawinna Walauwa
Source - Author



Fig 10 – *Kanappuwa* ,
Dambawinna Walauwa
Source- Author



Fig 11 – Foldable stool,
Dambawinna Walauwa
Source- Author

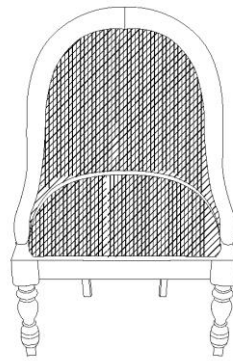

Fig 12 – feeding chair
Source- Author

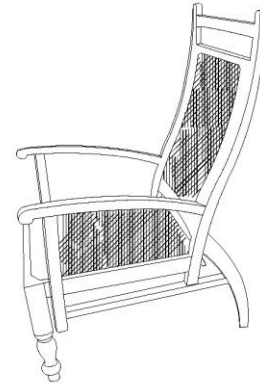

Fig 13 – Arm Chair
Source – Author

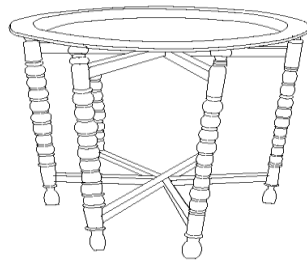

Fig 14- Foldable stool,
Source Author
Katugahagedara walauwa

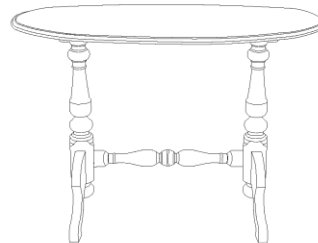

Fig 15 – Decorative stool
Samarakoon Walauwa, Source – Author

This area was a public Verandah, among all the decorative furniture pieces, this type of furniture was seen, poor decorations, Details and design. The verandah in *Dambawinna Walauwa* shows the inviting quality of the outsiders but silently orders the guest and directs them to the relevant seating through the furniture fig 11. Also positioned in the edge of the verandah which communicates among lower class.



Fig 16 – Feeding Chair in two Sizes
Dambawinna Walauwa. Source – Author



Fig 21 – Ash Tray details and the stool top with the brass tray detail in Katugaha and the corner image is the Details of the Uva Province Flag



Fig 17 – seating posture
Of Master Chair
Source – Author



Fig 18 – user behavior
in Feeding chair
Source – Author

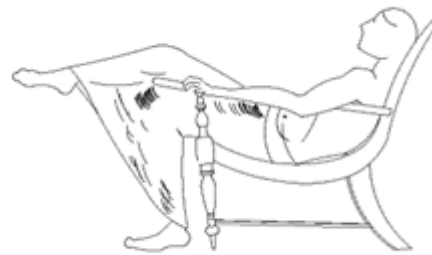

Fig 19 – seating posture in
arm Chair (haansi
putuwa), Source – Author

Furniture made of precious timber was placed in this *Walauwa* that depicts the wealth and power of the owner. The photographs of the Rathwathe generation were highly displayed in this area, this conveys the arrogance of the owner of his generation. And always want to build up the mindset of the outsider since they enter the verandah, that the owners' hierarchical status. Highly crafted corner stands used to display the Mr Rathnayaka photographs. And Buddhist paintings were displayed to convey the bond with the religion. According to later practice of Mr. Milroie Ratwatte, demolishing that furniture range expresses the inviting quality to all outsiders without considering the social classes.

The philosophy of harmony has been conveyed through the carving of the fan light using carving that mirrors through the center line. The painting on the top of the main entrance depicts the religious devotion towards the god. They believe this gives a protection to the entire living place and the family members. A two-seater chair made of *Nadun* timber. Highly decorated details on the top of the furniture that convey the message of prosperity of the owner.

There were an identical feature in this *Hansi putuwa*; Fig 19, a highly decorative ash tray made of brass were placed on the right arm of the chair, signifies British period. This non-verbally communicates the user behavior, the male user in this *Walauwa* were smoking. Ash tray is highly decorative to signify the wealth of the owner. This foldable stool that can be introduced as Mono Design made of Ebony timber; fig 14, top of the stool was made of brass. The stool can be folded flat, and the top brass plate can be removed. These were furniture used in the sense of exhibits. To non-verbally communicate the wealth and power of the owner. When the outsiders visit these type of below chairs were used by the owner to sit. The comfortable, simple details but conveys a hierarchical look for the others. The status of the user was signified through the seating posture. Semi-fixed features such as animal horns, and family photographs have been used as quick transitional elements that were “loudest” non-verbal communicative elements. No arm rest, less comfort ability a cheap

material together has built a furniture that convey a certain group of people. Seating posture of the furniture automatically create a gap between the high class and the low class; fig 20.

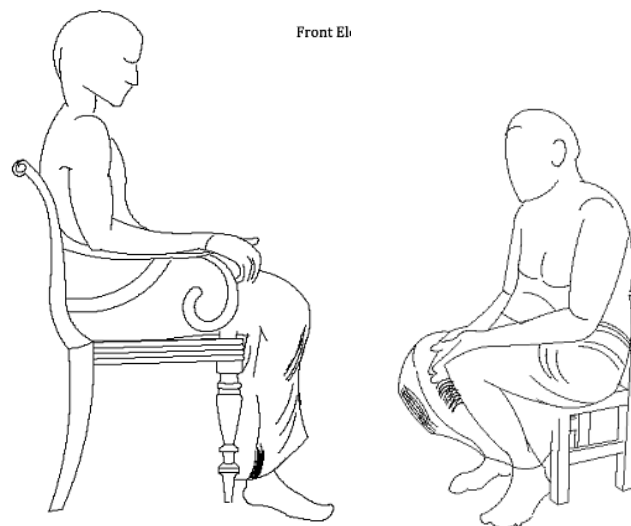

Fig 20 – Seating posture and the behavior of the high caste and the lower caste people

5. Conclusion

Socio- cultural appreciation of the society create a significance impression on the domestic dwelling with the aid of its characteristic elements. Since house is the most individual and the initial social unit and utilized by the same set of social members for a long term, that context contains a long term practiced socio- cultural aspects of the prevailed society. Elite living place “*Walauwa*”, was a dwelling used by the high caste people in the prevailed social structure, with a preserved set of social and cultural aspects (unique behaviors, hierarchical status).

Verandah is a unique element in this context. This space represent the total image of the users of the “*Walauwa*” which proportionately illuminate the significant of society in the prevailed period. Among them the Entrance verandah has been detected as the immediate and the initial transitional space. Semi fixed feature has played a huge role which non-verbally, visualizing, communicates the space stronger.

According to the logical analysis of the above three Verandah in the *Walauwa* context, three categories of Semi fixed features were identified. According to it prominent functions such as semi fixed features such as furniture used to express hierarchy ex; - Master chair, Furniture used to relax ex: - *Hansi Putuwa* and furniture and others furnishings used as exhibit without any functions of behavior. Ex:- Photographs

Human behavior, counting with the interaction and non-verbal communication, were influenced by roles, contexts, and situations plays on the context. In turn, they habitually communicated by clues in the settings. All these together communicates a particular group of people lived in the *Walauwa* context. With the comparison of the three *Walauw* in the Uva province, the over role communication and the transitional message was quiet similar. But the semi-fixed features such as furniture and the other elements was utilized to convey the message was conditionally unique to the owner of the *Walauwa*.

Proportion, size, Materials, details and aesthetics, behavioral pattern, seating posture and the layout together do a justice to reflect the social values of the furniture prevailed in the verandah. Since

verandah was a space that the out society and the inner society meet, the two different social impacts were clearly observed.

Early verandah that was a public area has become a semipublic space since after the British colonization. It was clearly understood the owners of the context non-verbally speaks to the outsiders to sit of the suitable position of the seating relevant to the prevailed caste system.

The influence of British colonization toward Uva province was clearly observed through the semi-fixed features in the Verandah. There were some similarities with the details used in some cases with the details of the flag of Uva province. Details were used in an abstract format figure 21. Behavior and hierarchy occurs in some context, and that setting is based on meaning, it follows that people behave diversely in same contexts by interpreting the available clues for their meaning. With the Semi-fixed elements Verandah was the main communicating space, which acts as an emblem in 'walauwa' context, which non-verbally communicate behavioral patterns and hierarchy of a prevailed society.

6. Reference

- Daswatte, c. (2006). *Sri Lanka Style, Tropical Design & Architecture*. colombo: Periplus Editions (HK) Limited.
- deCosta, S. (2012). *Resplendent Uva : the garden of Sri Lanka*. Badulla: Ministry of Tourism, Provincial Council of Uva 2012.
- Fernando, B. (1996). *Historical and Architectural Appreciation of Walauwa type building in Rathnapura District*. Moratuwa: University of Moratuwa, dissertation.
- Goonetilleke, J. (2012). *Atapattu Walawwa ,Residence of Gooneratne and Dias Abeysinghe, Families of Galle* . colombo: -. Kelegama .S, M. R. (2002). *400 years of Dutch- Sri Lanka Relations; 1602-2002*. colombo.
- Knownx, R. (1681). *An historical relation of the Island Ceylon*. London: Richard Chiswell.
- Lewcock R, S. B. (2010). *The architecture of an island*. colombo 7.: ,Sarvodaya vishva Lekha.
- Madugalle, S. (2005). *Four Kandyan Families FROM THE MAHA DISSAWANI*. colombo: vijitha Yapa publications.
- Mendis, G. (2005). *Ceylon under the British*. New Delhi: Gautam Jetley.
- Mondal, P. (2016). The Meaning and Functions of Social Values | Sociology. *YourArticleLibrary*..
- Brohier, R.L (1969). *Furniture of the Dutch period in Ceylon*. colombo: Museum publications.
- Rapoport, A. (1982). *The meaning of the built environment* . united States: SAGE publications.
- Lewcock, R, B. S. (1998). *The Architecture of an Island. The Living Heritage of Sri Lanka*. Colombo: Colombo Barefoot .
- Saeewa, B. S. (1997). *Architectural appreciation of the elite residences constructed during 19th and early 20th century in Sri lanka* . Moratuwa: university of moratuwa ,dissertation .
- Samarasignhe, P. (2004). *The relationship between social hierachy and use of furniture in Sri Lanka During 19th century and 20 th century*. Moratuwa: Univertsity of Moratuwa ,Dissertation.
- vos, A. D. (2015). Making built environments responsive. *Faru international conference* . colombo: Faru proceeding.
- Wright, A. (2004). *Twentieth Century Impressions of Ceylon*. New Delhi: AES Publication Pvt. Ltd.

Samarawickrama, Sumanthri, et al (eds), 2018, "Sustainability for people - envisaging multi disciplinary solution": *Proceedings of the 11th International Conference of Faculty of Architecture Research Unit (FARU), University of Moratuwa, Sri Lanka, December 08, 2018* Galle pp. 448–456 ©

COMPETENCIES OF QUANTITY SURVEYORS IN A DEVELOPING ECONOMY

VIDANA GAMAGE SHANIKA¹, YASHODA DISSANAYAKE² & VIJITHA DISARATNE³

^{1,2,3}Department of Building Economics, University of Moratuwa, Sri Lanka

¹vgshanika9@gmail.com, ²dissanayakeyashoda@gmail.com, ³vijitha.disaratna@gmail.com

Abstract

As a prominent construction professional in the construction industry, quantity surveyor shall be sharp with required competencies to overcome the challenges within a developing economy context. Therefore the study is directed to identify the gap between the current level of competencies and the required level of competencies of quantity surveyors in a developing economy and providing recommendations to bridge the gap. This research was driven into a mixed approach which includes desk review, expert surveys, questionnaire survey and expert interviews as data collection methods in order to accomplish the research aim. Initially a desk review was conducted to identify the competencies of quantity surveyors. Then an expert survey was carried out to build up a list of competencies in given context. After a questionnaire survey was conducted to seek the current level of competencies and then expert interviews were conducted to check the required level of competencies and the collected data were analysed with descriptive statistics to determine the gap. Mean, Standard deviation and Mode were used as analyzing tools to calculate the gap between. Further, recommendations were derived through expert interviews to bridge the identified gap by adapting the content analysis method. Continuous professional development programmes for quantity surveyors and periodical changes to the curriculum of quantity surveying academic courses were the common recommendations given. Within them, it is essential to contain development appraisals, financial management during construction, coordinating cash flows, resolving disputes and BIM management competencies as those are lacking in the given context.

Keywords: *Competencies, Quantity Surveyors, Developing Economy*

1. Introduction

Construction industry is complex, interdependent, and broad as construction projects lead the industry to be more complicated day by day. A static relationship can be seen between construction industry and other sectors of economy. The improved efficiency of construction industry results national economic growth and ensures cost effectiveness and could contribute to cost savings for whole country (Aibinu and Jagboro, 2002).

For analytical purposes, World Economic Situation and Prospects (WESP) classifies all countries of the world into one of three broad categories: developed economies, economies in transition and developing economies (United Nations, 2014). Developing economy has its own characteristics. Agricultural sector of developing countries accounts a major part in the Gross Domestic Production (GDP) (WESP, 2015). Developed countries are more towards to service oriented economies. WESP (2015) and United Nations (2014) have declared that Sri Lanka, India, Pakistan, Nepal and Bangladesh are some of developing countries in Asia. Further, Ehelepola (2016) states that Sri Lanka is a small developing country in South Asia.

According to World Bank (2013) Sri Lanka is a developing country with a growth rate of 4.8%. Construction is the second largest industrial segment in Sri Lankan economy, and have recorded a 6.6 percent growth in 2014 (Central Bank of Sri Lanka, 2014). Construction is a fundamental requirement of a developing economy, because development of other industries and the upliftment of the living status creates a demand on the construction industry, since other industries are heavily depending on construction products. According to Allan et al (2008), a construction boom can be seen in many developing economies. The supply shall meet the demand in order to cater the requirements of developing economy. Increase in economic activities have generated heavy demand for construction

(Chen and Chen, 2010). Developing economy changes the client's needs and wants, and have made construction professionals' involvement more complex such as quantity surveyors, engineers, architects and etc.

Quantity surveying is a crucial profession in current construction industry. Further, Quantity surveyor's contribution on overall construction project performance is given by acquiring, and deploying appropriate competencies (Nkado, 2000). The profession of quantity surveying has come across a threatened situation because of the traditional roles and the performance under the circumstances of developing economy (Nkado and Meyer, 2001). Royal Institution of Chartered Surveyors [RICS] (2014) defines competency as "the skill or ability to perform a task or function". Further, it is a description of an action, a mode of behaviour or outcome that a person should be able to demonstrate, or the ability to transfer skills and knowledge to new situations within the occupational area (Holmes and Joyce, 1993).

A research has been done on the topic "Competencies of Professional Quantity surveyors in a Developing Economy" by R. N. Nkado in year 2000.

According to Nkado (2000), in this research, a model of competencies required by the quantity surveying service providers, is presented with the use of data which were collected by South African quantity surveyors. This research is mainly based on South African context and completed in year 2000, nearly seventeen years ago.

RICS has updated the required competencies with new competencies (RICS, 2014). Australian Institute of Quantity Surveyors (AIQS) has changed competencies throughout this seventeen years. Sri Lankan construction context and South African context are two different contexts. Especially Sri Lankan construction industry shows a rapid growth with the development of economy. Considering the obsolescence, rapid changes in the construction industry as well as the context difference, a research gap has been identified regarding identifying quantity surveying competencies in a developing economy, and addressing the current gap in the industry.

Another research is done on the topic "Competencies Expected of Graduate Quantity surveyors by the Construction Industry at Present and Future" by G. Yogeshwaran in 2014. The aim of this research was to identify the gap between competencies of graduate Sri Lankan quantity surveyors and to find required or expected competencies by the construction industry. Nevertheless, this research does not specifically identify what are the competencies of quantity surveyors that shall be specifically developed in a developing economy context. Thus, a clear research gap can be identified in driving a research to identify the competencies of quantity surveyors in a developing economy. Therefore, the aim of this research is to analyse the competencies of quantity surveyors in a developing economy. However, the aim was achieved by fulfilling following objectives.

1. To identify competencies required by a quantity surveyor in a developing economy.
2. To determine the gap between required and current competencies.
3. To provide recommendation to bridge the gap

The competencies considered were limited to which have been defined by professional bodies namely, RICS, Pacific Association of Quantity Surveyors (PAQS), Institute of Quantity Surveyors Sri Lanka (IQSSL) and AIQS. Data collection by questionnaire survey was limited to Sri Lankan construction industry.

2. Research Methodology

Research methodology refers to systematical and rational approach of investigation system with a scientific background. Data collection of this research was done by four methods. Adopted methods were desk review, expert survey, questionnaire survey and finally an expert interview round.

A desk review was conducted and competency standards which are published by RICS, AIQS, IQSSL and PAQS were merged together with findings of the study by Yogeshwaran (2014) to develop a common list of competencies required from a quantity surveyor. Then an expert survey was carried out

to validate the common list of competencies and to derive competencies considering the developing economy context.

After questionnaire survey was carried out, adhering to the quantitative approach among the industry practitioners to identify the current level of competencies of quantity surveyors in a developing economy. Respondents were selected through convenience sampling method. Finally, an expert interview round was conducted to identify the required level of competencies construction industry expect out of the quantity surveyors in the given context and to provide recommendations to bridge the gap.

As both quantitative and qualitative methods were adapted mixed approach was used for the study. Mean, median, standard deviation and manual content analysis are the adapted analysis tools for the study.

3. Findings and Analysis

Quantity surveyors are one of the professional who involves in the construction process since the inception, until the completion. Brandon (1994) emphasises, quantity surveyor as an essential professional who can make construction projects more feasible with cost effective techniques while adding more value to the ultimate product. Quantity surveyors have to face many challenges and opportunities, but generally opportunities are mainly neglected and challenges do not overcome predominantly due to lack of relevant skills and competencies (Dada and Jagboro, 2012).

There is an expectation that the quantity surveyor's role will develop further in future (Wao and Flood, 2016). As stated in Ashworth et al (2013) quantity surveyors are required to be exploring new potential roles regarding to new opportunities and strengths. Therefore, quantity surveyor's skills and competencies should be updated in order to change their roles with regard to the new market situation.

Competencies of quantity surveyors have been defined in various viewpoints (Nkado and Meyer, 2001). To avoid the mix-up there should be a well-established and well defined and accredited set of competencies for quantity surveying profession. Thus, at the present core competencies of quantity surveyors are outlined by governing professional bodies (Perera et al, 2010).

3.1. DESK REVIEW

RICS, PAQS, IQSSL and AIQS are the leading professional bodies which govern quantity surveyors in Sri Lanka (Yogeshwaran et al, 2014). These professional bodies certify the excellence of professional practitioners of quantity surveying and maintain the required standards while governing the accreditation of quantity surveying education and its degree programs. Thus, these professional bodies have individually published sets of competencies expected from quantity surveyors who work in construction industry. Hence an in-detail analysis of competencies published by main quantity surveying professional bodies namely IQSSL, RICS, PAQS and AIQS was carried out as a part of achieving objective one.

3.1.1 Yogeshwaran (2014)

This is a research done on the topic "Competencies expected of graduate quantity surveyors by the construction industry at present and future" in 2014. In the path of achieving objective one of the research, a common set of competencies had been prepared studying PAQS, AIQS, RICS and IQSSL quantity surveying competencies. Thematic analysing method was used to analyse the data which had been collected through the desk review. The common set of competencies were categorized under main 23 areas. The list was prepared using RICS Competencies which were outlined in 2013, AIQS competencies published in 1997, PAQS competencies published in 2001 and latest IQSSL competencies. This research was recently done in a systematical manner. The common list of competencies of quantity surveyors had been validated by the experts in the industry and many journal papers have been published based on the research. The common list which was prepared in this research was used in the desk review.

3.1.2 Updating Yogeshwaran (2014)

RICS and AIQS have updated competencies for quantity surveyors after 2014. RICS has published a document, "Assessment of professional competence" for the sector of quantity surveying and construction in 2015. AIQS has updated competencies of quantity surveyors in May 2012. A major change can be observed in RICS competencies. RICS 2013 competencies got 10 mandatory competencies, 7 core competencies and 10 optional competencies. But in RICS 2015 update, there are 10 mandatory competencies, 6 core competencies and 11 optional competencies. Building information modelling (BIM) management has been introduced as a new optional competency.

A major change cannot be seen between the AIQS latest update and AIQS Competencies which were used in Yogeshwaran (2014). IQSSL and PAQS competencies have not been changed after 2014. Thus, the common list of competencies was slightly changed according to the changes of the competency standard changes. The common list which was prepared by Yogeshwaran (2014), was updated relevant to the changes in the competencies.

The desk review was mainly focused on AIQS, RICS, IQSSL and PAQS competencies while referring to Yogeshwaran, (2014). Validation of common competency list and identification of crucial competencies of quantity surveyors which are specific for a developing economy is done through an expert survey.

3.2 EXPERT SURVEY FINDINGS

Expert survey was conducted to validate the findings of the desk review and to derive competencies of quantity surveyors from the validated common list considering the developing economy context. Four industry experts in field of quantity surveying were participated in the expert survey. Initially the common list of competencies was validated through all four experts who have sophisticated knowledge in the subject of the research.

All four experts validated the desk common list of competencies with minor changes. Two of expertise pointed out that the competency "Managing risk" which is included in the common list shall be changed as "Managing financial risk", since most of the time quantity surveyors deal with financial risk management rather than other risk management approaches. Therefore, after the validation the competency "Managing risk" was altered as "Managing financial risk". Thus, desk review findings were validated.

Then all those four experts were interviewed to identify the crucial competencies of quantity surveyors in a developing economy, out of the validated common list. All four experts were given same chance to select the competencies out of the given common list. Each selection has given a single mark, and total marks were considered when selecting the paramount important competencies for quantity surveyors in a developing economy. The minimum mark that a competency can get is zero and the highest is four. Competencies which were scored over two has been selected as the crucial or paramount important competencies. The list of competencies is shown within Table 1 under the section findings and analysis. Thus, competencies expect from a quantity surveyor in a developing economy was identified achieving the objective one.

3.3 QUESTIONNAIRE SURVEY FINDINGS

A comprehensive questionnaire was prepared and distributed among 53 quantity surveyors who are currently working in the Sri Lankan construction industry which is considered to be a developing economy context. Out of 53 practitioners, 33 quantity surveyors were responded and the collected data were subjected to the analysis.

Respondents were asked to indicate within the given Likert scale from 1-5, current level of competencies possessed by quantity surveyors who are practicing in the Sri Lankan construction industry. This scale was used to give a numerical value to the responses and to take the mean of each quantity surveying competency which was identified as crucial to a developing economy.

Median is the numerical value which separates the higher and lower parts of a data set. The set of data is arranged according to the ascending order and the middle number of the data set will be selected as the median. Median gives an idea that set of data is not skewed by extreme large and small values, compared to mean.

All competencies have scored a very low standard deviation, and it shows that the data does not have a wide spread. Thus, it points out that the data is more concentrated around the mean. The highest standard deviation is 1.22 and it's for the competency "contractual interpretation". Median substantiates that most of the competencies have scored "Average" and "High" level of competent of industry practitioners. Thus, it is rational to take the mean of the data set as the comparative outcome of the questionnaire survey analysis. Findings of questionnaire survey are indicated in the Table 1 given under findings and analysis section.

3.4 EXPERT INTERVIEW FINDINGS

With the completion of questionnaire survey, expert interviews were conducted to identify the required level of competencies of quantity surveyors in a developing economy and finally to provide recommendations while achieving objective two and three. The same set of experts who participated in the expert survey while achieving objective one, were interviewed.

Experts were also asked to indicate the required level of competencies within the given Likert scale similar to the one used in questionnaire survey. A mean value was derived from the data collected data out of the four experts. The average value was used to do the comparative analysis.

It could be noticed that measurements, BOQ preparation, tender documentation, interpretation of drawings and documents and professional practice are the highly required competencies out of the quantity surveyors of a developing economy. Carrying out life cycle cost analysis and developing a resource management plan are the least required competencies.

Difference between the required level of competencies and current level of competencies defines the gap, and the lack of the competencies of quantity surveyors in a developing economy. Thus, Table 1 indicates the findings related to objective one (desk review and expert survey) and objective two (questionnaire survey and expert interview) which shows about competencies expect from a quantity surveyor in a developing economy and existing gap between current level of competencies and required level of competencies from a quantity surveyor within the given context.

Table 32: Findings of expert survey, questionnaire survey and expert interviews

Area	Competency	Questionnaire Survey Findings (Current level of Competencies)			Expert Interview Findings (Required level of Competencies)	Gap
		Median	SD	Mean	Mean	
Cost planning	Analysing alternative design solutions	3	0.92	3.03	4.00	0.97
	Cost controlling during design	3	0.96	3.36	4.00	0.64
	Preparation of cost plans	3	1.18	3.48	4.50	1.02
	Scope audit	3	0.81	3.03	4.50	1.47
Cost estimating	Managing cost data	4	0.70	3.64	3.75	0.11
	Preparation of estimates	4	0.77	4.09	5.00	0.91
	Review, evaluation of estimates	4	0.86	4.06	5.00	0.94
Strategic planning	Preparation of cost benefit analysis	3	0.98	2.97	4.00	1.03
	Economic and financial analysis	3	1.02	2.88	3.75	0.87

Area	Competency	Questionnaire Survey Findings (Current level of Competencies)			Expert Interview Findings (Required level of Competencies)	Gap
		Median	SD	Mean	Mean	
	Carrying out development appraisal	3	1.17	2.79	4.00	1.21
Contract administration	Progressive financial monitoring, reporting and controlling during construction	4	0.97	3.76	5.00	1.24
	Recommending progress payments/interim valuation	4	0.88	4.18	4.50	0.32
	Managing claims	4	0.95	3.97	4.75	0.78
	Managing variations	4	0.95	4.09	4.50	0.41
	Final accounts and reporting	4	1.03	4.06	4.75	0.69
	Managing cash flow during construction	4	1.07	3.73	4.50	0.77
	Administering insurance claims	3	1.08	3.21	4.75	1.54
	Administering, managing of subcontracts and controlling subcontract accounts	4	1.04	3.82	4.75	0.93
	Contractual interpretation	4	1.22	3.64	4.50	0.86
	Dispute resolution	Resolving disputes	3	0.81	2.85	4.50
Contract documentation	Establishing client requirements	4	0.83	3.67	4.00	0.33
	Measurement	3	0.61	4.42	5.00	0.58
	Preparation of BOQ	4	0.83	4.45	5.00	0.55
	Developing resource management plan	3	1.09	3.18	2.75	-0.43
General procurement advice	Review procurement systems	3	0.98	3.48	4.00	0.52
Tendering process	Managing tendering process	4	0.82	3.97	4.75	0.78
	Tender documentation	4	0.69	4.30	5.00	0.70
Government law and regulation	Knowledge on law, regulations and guidelines related to construction	3	0.87	3.48	4.75	1.27
Construction technology	Knowledge on construction technologies, process and building materials	4	0.95	3.70	4.25	0.55
	Knowledge of principals of construction	4	0.92	3.70	4.00	0.30
	Interpretation of drawings, specification and other documents	4	0.97	4.06	5.00	0.94
	Design and installation of services	3	1.10	3.30	4.25	0.95
Value management	Providing value management services	3	0.91	3.09	3.75	0.66
Life cycle cost analysis	Carrying out life cycle cost analysis	3	0.95	2.76	2.75	-0.01
Budgetary process	Coordinating client's cash flow	3	1.19	3.21	4.75	1.54
Financial audit	Knowledge on accounting principles, cash flow, cost reconciliation	4	1.03	3.42	4.50	1.08
Ethics and professional conduct	Professional practice					1.27
		4	1.04	3.73	5.00	
Feasibility study	Feasibility study	4	1.10	3.27	4.00	0.73
Health and safety	Knowledge on health and safety requirements in construction	4	0.90	3.55	4.25	0.70

Area	Competency	Questionnaire Survey Findings (Current level of Competencies)			Expert Interview Findings (Required level of Competencies)	Gap
		Median	SD	Mean	Mean	
Support competencies	Computer services	4	0.70	4.06	4.75	0.69
	Team working	4	0.79	4.24	4.50	0.26
	Due diligence	4	0.95	3.82	4.25	0.43
	Leadership	4	0.82	4.21	4.00	-0.21
	Managing people	4	0.83	3.85	3.75	-0.10
	Communication, presentation skills	4	0.97	3.85	4.75	0.90
	Client care	4	0.91	3.85	4.25	0.40
	Economics	4	0.86	3.61	4.25	0.64
	Statistical Analysis	3	0.90	3.45	3.50	0.05
Sustainability	Knowledge on impact of sustainability in construction	3	0.78	3.09	3.50	0.41
Tax depreciation	Tax depreciation	3	1.05	3.12	3.50	0.38
Expert witness	Expert witness	3	1.09	3.06	3.50	0.44
Research and development	Research and development	3	0.80	2.91	4.00	1.09
Building information modelling	BIM management	2	0.83	2.06	3.50	1.44

Experts were further asked to provide recommendations to bridge the gap between current and required levels of competencies. A separate sheet of average levels of current competencies was given to all experts which consists of questionnaire survey data analysis. Based on that data the gap has been defined and the recommendations were provided to bridge the gap after observing the relevant gap.

The recommendations were analysed through manual content analysis and findings were further considered to conclude with available recommendations. The recommendations are tabulated in Table 2 as follows.

Table 33: Recommendations made by experts

Expert	Recommendations
A	<ul style="list-style-type: none"> Changing the content of the academic courses according to the requirement. Consecutive continuous professional development programmes.
B	<ul style="list-style-type: none"> Compulsory continuous professional development programmes for professionals. Syllabus of the academic courses shall be updated to the current and future requirements of the industry.
C	<ul style="list-style-type: none"> At present competency level of quantity surveyors in Sri Lanka is superficial. We need standard multi-level competencies for the profession and then develop the bottom up.
D	<ul style="list-style-type: none"> Increasing required standard continuous professional development hours by regulated bodies. Content of academic courses can be changed according to the requirements.

4. Conclusions and recommendations

The study was aimed to analyse the competencies of quantity surveyors in a developing economy and the aim was attained through the achievement of identified objectives. Initially set of competencies expected from the quantity surveyors in a developing economy context were identified including 53 competencies under 23 main areas. Then the gap between current and required level of competencies were derived which indicated substantial gap between most of the competencies. Anyhow recommendations were made analysing the expert views.

This research has emphasized the need of continues professional development programmes for the industry practitioners to keep the competency standard of the practitioner in line with the industry requirement. When it considers the developing economy the industry need vary in a quick diverse nature. Thus, it is important to identify the competency gap and allocate continuous professional development programmes to industry practitioners.

Curricula of the academic courses shall be changed in order to cater the rapid changing requirement of the industry. In developing countries, the course content shall be changed periodically to match the industry need, and to providing quantity surveyors who have got enough knowledge, skill and ability to perform the assigned task.

It is paramount important to contain development appraisals, financial management during construction, coordinating cash flows, resolving disputes and BIM management in to the CDP programmes and as well as in the curriculum of academic courses, since it shows a greater inadequacy of competencies in those areas.

By bridging the gap between the industry need and the quantity surveyor's current competency level some major changes could be seen in a developing economy. The high competency levels of quantity surveyors would ensure to address most of the construction related issues risen within the industry in developing economies within the quantity surveying scope.

5. References

- Aibinu, A. and Jagboro, G. (2002). The effects of construction delays on Project delivery in Nigeria construction industry. *International Journal of Project Management*, 20(8), 593-599.
- Allan, N., Yin, Y. and Scheepbouwer, E. (2008). *A study into the cyclical performance of the New Zealand construction industry*. Christchurch: New Zealand Centre for Advanced Engineering.
- Ashworth, A., Hogg, K. and Higgs, C. (2013). *Will's practice and procedure for the quantity surveyor*. London: John Wiley & Sons.
- Brandon, P. (1994). *Quantity surveying techniques: New directions*. London: Blackwell Scientific Publications.
- Central Bank of Sri Lanka. (2014). *Annual Report 2014*. Colombo: Central Bank of Sri Lanka.
- Chen, J. and Chen, J. (2015). The characteristics and current status of China's construction industry. *Construction Management and Economics*, 37-41.
- Dada, J. and Jagboro, G. (2012). Core skills requirement and competencies expected of quantity surveyors: Perspective from quantity surveyors, allied professionals and clients in Nigeria. *Australian Journal of Construction and Economics*, 12(4), 78-90.
- Ehelepol, K. (2016). An estimated open economy new Keynesian DSGE model for Sri Lanka. *Proceedings of 8th Central Bank of Sri Lanka International Research Conference* (pp. 1-47). Colombo: Central Bank of Sri Lanka.
- Holmes, L. and Joyce, P. (1993). Rescuing the useful concept of managerial competence: From outcomes back to process. *Personnel Review*, 22(6), 37-52.
- Nkado, R. (2000). Competencies of professional quantity surveyors in a developing economy. *Methodology*, 15-17.
- Nkado, R. N. (2000). Competencies required by quantity surveyors in South Africa. *16th Annual ARCOM Conference*, (pp. 6-8). London: Association of Researchers in Construction Management.
- Nkado, R. and Meyer, T. (2001). Competencies of professional quantity surveyors: A South African perspective. *Construction Management and Economics*, 19(5), 481-491.
- Perera, S., Pearson, J. and Dodds, L. (2010). Alignment of professional, academic and industrial development needs for quantity surveyors. *RICS COBRA Research Conference*. Paris: RICS.
- RICS. (2014). *Assessment of professional competence quantity surveying and construction pathway guide*. London: RICS.
- United Nations. (2014). *World Economic Situation and prospects*. Geneva: United Nations.
- Wao, J. and Flood, I. (2016). The role of quantity surveyors in the international construction arena. *International Journal of Construction Management*.
- World Bank. (2013). *Annual World Bank Report 2013*. Washington DC: World Bank.
- World Economic Situation and Prospects. (2014). Country classification. World Economic Situation and Prospects.
- Yogeshwaran, G. (2014). Competencies expected of graduate quantity surveyors by the construction industry at present and future. Department of Building Economics, University of Moratuwa, Sri Lanka.

Yogeshwaran, G., Perera, B. and Perera, K. (2014). Competencies expected of graduate quantity surveyors by the construction industry at present and future. *FARU Journal*, 6(1), 7-17. Retrieved from <http://www.mrt.ac.lk/foa/faru/documents/FARU%20Journal%202014.pdf>.

Samarawickrama, Sumanthri, et al (eds), 2018, "Sustainability for people - envisaging multi disciplinary solution": *Proceedings of the 11th International Conference of Faculty of Architecture Research Unit (FARU), University of Moratuwa, Sri Lanka, December 08, 2018* Galle pp. 457-464 ©

PERCEPTION OF CONTRACTORS ON USAGE OF ALTERNATIVE DISPUTE RESOLUTION METHODS IN CONSTRUCTION INDUSTRY OF SRI LANKA

DISSANAYAKE D.M.A.B¹, ABEYNAYAKE M.D.T.E² & PANDITHAWATTA T.P.W.S.I³

^{1,2,3}University of Moratuwa, Katubedda, Sri Lanka
dissanayake.anuruddha@gmail.com

Abstract

Construction industry is a complex and high-risk industry where large variety of parties with different skills are involved. Due to this multi-party involvement and their diversified interests, construction projects experience disputes. With the constant upsurge of complexities in construction industry, the industry would have to experience disputes among the parties for a foreseeable future. As disputes are unavoidable it is necessary to mitigate the negative impacts of it by using a proper method of resolution. Therefore, selecting the best method for resolving the dispute, influence in obtaining best solution. As the study aims to identify perceptions of contractors towards Alternative Dispute Resolution (ADR) methods and to identify significance of factors considering in selecting ADR method by contractors', literature review was carried out to identify the factors influence in selecting ADR methods. Those collected data from the literature review was validated by a preliminary survey which had been carried out among experts in the area of dispute resolution. Then detailed questionnaire survey was conducted by using results of the preliminary analysis to evaluate the perception of contractors on ADR methods and to evaluate significance of factors which affect the selection of most suitable ADR methods. Research results revealed that negotiation is the frequently used method in dispute resolution in Sri Lankan construction industry and the most popular ADR methods from the contractor's perception are negotiation and adjudication. Further, findings proved that considerable number of contractors have a high awareness on the legislation provisions relating to negotiation and its settlement and participant's satisfaction rates are significantly high rather than other available ADR methods.

Keywords: *Alternative Dispute Resolution; Contractors; Construction industry, Dispute; Perception.*

1. Introduction

Construction industry is considered as an industry which significantly contributes in terms of scale and share in the development process for both developed and developing countries (Wibowo, 2009). As stated by Emuze & Isa (1999) disputes are mostly occurs from the complexity of the work, involvement of various contracting parties, incomplete contract documents, money related issues, and correspondence issues. Further, Semple (1994) stated that great deal of conflicts arises due to complexity, multiparty involvement and associated risk. any of factor which causes a dispute have the ability to disrupt a project and pave the way to complicated litigation or arbitration, cost increasing and a conflict among parties (Harmon, 2003). Therefore, disputes need to be mitigated in order to minimize above mentioned impacts.

Disputes in construction can occur between various stakeholders such as clients and contractors, consultants and contractors, contractors and suppliers, contractors and employees, and so on (Emuze & Isa, 1999). Oshodi & Ejohwomu (2014) identified that conflicts in construction projects arise due to differences in interest, concerns, training, and perception of individuals. To avoid such results the construction industry has been making efforts in evolving and establishing effective techniques in preventing and resolving disputes (Kubal, 1994). Abeynayake & Weddikkara (2013) stated that necessity of fast and cost-effective dispute resolution method placed due to demand for the construction in Sri Lanka. Authors further stated that in last few decades the industry moved to 'Alternative Dispute

Resolution' (ADR) methods in order to solve disputes from litigation due to its high costs, delays, and adversarial relationship.

According to the Blain, Goodman, & Loewenberg (1987) ADR maximizes the opportunities available for parties to resolve disputes prior to or during the use of formal administrative procedures and litigation, this research intend to recognize the perception of contractors on ADR methods and to evaluate factors affecting to the selection of ADR methods in Sri Lankan Construction Industry.

2. Literature Review

The Construction Industry is made up of role players like the employer, the contractor and consultants who endeavour to create long – term, unique and complex building projects and infrastructures (Levy, 2007). Some diverse arrays of stakeholders i.e. the client who may be either individual or local authority, the consultant, the main contractor, sub-contractors, suppliers, financial institutions, legal representatives and others all contribute to a building project from planning through design, construction and occupancy (Andoh, 2010). These role players sometimes bring varying and sometimes conflicting expectations to a project. They operate in an environment in which their influences over a project swing as the project progresses. They demand to deliver projects in less time and at lower cost (Andoh, 2010). The construction industry is a project- based industry with each project being unique (Yusof, Ismail, & Chin, 2011) hence noted for high levels of disputes and conflicts.

A failure of one party involved in the project can affect to other participants within the project which could be end in a dispute. The complex dispute found in construction projects arose from the fact that construction projects are increasingly complex (Harmon, 2003). The industry has often been described as one of the most adversarial and a problem prone industry, where claims and disputes on construction projects are frequently considered as the rule rather than the exception (Steen, 2002). Dispute is an argument or a disagreement between two persons or groups (Oxford dictionary). Arthur & Marriott, (1999) stated that it is essential to find out dispute causes related to construction industry to smooth process of the construction. However, proper management tool is not identified still in the industry and because of that dispute are very common in the industry.

Poor project management skills, lack of attention to the details relating to project structure, poor communication skills, poorly prepared contract document, inadequate planning and financial issues were identified by Harmon, (2003) as causes to arise disputes (Figure 1).

2.1. DISPUTE RESOLUTION

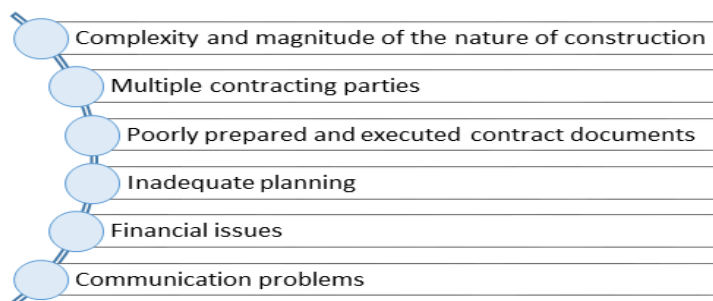

Figure 60, Causes of Disputes

Mose & Kleiner, (1999), has elaborated how disputes resolution has now emerged as a strategic plan in business. Nevertheless, Lathem, (1995) proposes, dispute avoidance as the best solution rather than seeking solutions for raised disputes.

In the early days of construction, most disputes were settled on the jobsite at an informal meeting between the resident engineer and the contractor on the basis of a handshake. According to Blain, Goodman & Loewenberg (1987) Arbitration was probably the earliest method of alternative dispute resolution, Arbitration arose when two parties to a contract were unable to agree and wanted to submit the question to an impartial party to decide the issue.

Winning a dispute is important to both parties (Loosemore,1999). Litigation is a dispute resolution method which proceed at courts and legally enforceable (Asworth 2002). According to the Gill, Gray,

Skitmore, & Callaghan, (2015) litigation means an enforcing a right by a contest authorized by law. In addition professional judges, lawyers and technical advisors are participated in the proceedings. Pagone, (2008) shows that cost involved in the litigation process as a difficult factor to control. Proving that Gill et al., (2015) states, litigation is one of the most expensive ways to resolve a dispute. He further states that litigation is not suitable option to resolve disputes other than for the projects that involve large amount of money. Dissatisfaction with litigation and arbitration has resulted in attempts to find other means for the quick resolution of contract disputes, commonly referred to as alternative dispute resolution, or ADR.

2.2. ALTERNATIVE DISPUTE RESOLUTION METHODS

At present, different ADR methods have been identified and adopted by stakeholders in the construction and commercial sectors in Sri Lanka. Negotiation, Mediation, Adjudication and Arbitration can be identified as recognised ADR methods in the construction industry. Most of those methods are statutory controlled except negotiation which can be identified as a private and confidential method with minimal outside intervention.

Abeynayake (2014) has elaborated ADR as alternative means to traditional litigation systems. Further, ADR methods include dispute resolution techniques which are independent from the governmental judicial system. This can be proved by the Arbitration Act of 1995. According to this act, arbitrators have given the judicial power to take decisions while regarding those decisions as final and binding. The main advantage of ADR is that disputes that are connected with technical matters, can be decided by someone who has a sufficient technical knowledge and exposure to construction industry. Another advantage of ADR method is the encouragement given to resolve the disputes outside the court. Moreover, it is also generally believed that ADR offers a faster and less expensive alternative to litigation.

2.3. TYPES OF ADR METHODS

According to (Gould, 2004) disputes may be resolved at an early stage through negotiation or it may be preceded through several stages through mediation, conciliation and arbitration. The flow diagram of ADR methods shown in the Figure 2. The practicing of ADR methods can be indicated as a stair step way (O'reilly & Mawdesley, 1994) That means ADR methods reposes an escalator. The following chart illustrates the escalating levels in hostility and cost associated with the various forms of dispute resolution.

2.3.1 Negotiation

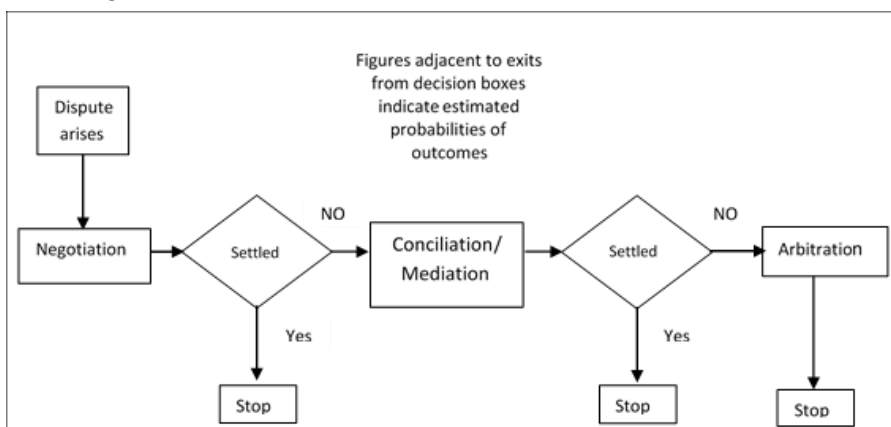

Figure 2, Flow diagram of ADR application (Source: O'reilly & Mawdesley, 1994)

Negotiation is a common dispute resolution method used by the disputants without the involvement of any neutral party (Spittler & Jentzen, 1992). According to McMurtry (2012) negotiation is an unstructured and voluntary process. Commonly used whenever the parties tend to negotiate to resolve the dispute. Outcome will create a win – win situation and both parties will be satisfied (Loosemore, 1999). Spittler and Jentzen, (1992) stated that there should be fairness to the parties involved in the negotiation process. He further stated that it also depends on their perception, ego, emotion and communication.

Negotiation is more economical than court procedure, Privacy of the proceeding, short duration and informal procedure are identified as advantages of using Negotiation. McMurtry (2012) identified

major barriers to solve disputes by using negotiation. Those barriers are the attitudes of parties, lack of negotiation skills among industry professionals, cultural differences among parties, lack of participation of competent professionals, use of negotiation as a time passing tactic and professional judgement.

2.3.2 Mediation

Mediation is a process where disputants meet with an outsider who is unbiased and get help to avoid deadlocks in coming to their own solution (Levy, 2007). Mediation is different from negotiation because it gets the help of a neutral third party. It has been identified by Jahren & Dammeier (1990) that mediation is a voluntary and private dispute resolution process which structured with the rules previously agreed by the parties. Bruni (2012) has shown in his studies that mediation is one of the most appropriate method to deal with construction dispute by considering certain important features such as speed and flexibility. Further author has identified confidential, quick, cheap, non-binding, flexible and informal process as the advantage of mediation.

2.3.3 Adjudication

Adjudication is an alternative dispute resolution method famously used in construction dispute resolution. During adjudication the disputes will be referred to a third party to gain a decision (Abeynayake, 2014). Further, the decision will be bound on parties until the dispute is resolved by arbitration or litigation. This method was initiated in England by Housing Grants, Construction and regeneration Act in 1996 (Van der Merwe, 2009). Milburn (2006) explains that scope of the project is not a limitation to the adjudication. He further stated that adjudication was introduced to refer simple and complex matters, and it is called as “one size fits all”. Moreover, if a sole arbitrator is not sufficient a board of three persons can be appointed. There can be one representative from each party and the other one can be an independent chair person.

Ranasinghe (2011) viewed adjudication as a five-way process (Figure 3). Adjudication can be mentioned as an economical and speedy process and the hearing is not conducted in a very formal manner. Decisions of adjudication are enforceable and the adjudicator may use his own initiatives rather than using natural justice. Abeynayake (2014) has identified some more drawbacks relating to adjudication dissatisfaction in large scale and complex disputes, imposed time table, risk of amplifying the cost, wide powers of the adjudicators and the need for qualified adjudicators.

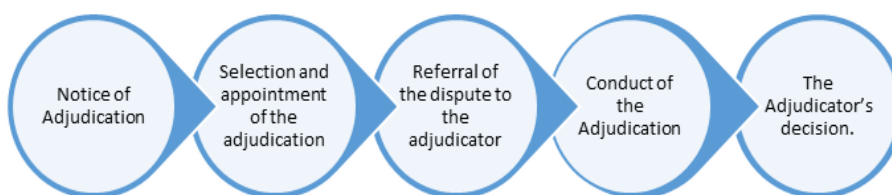

Figure 3, Adjudication process (Source: Ranasinghe, 2011)

2.3.4 Arbitration

The construction industry is highly adapted to arbitration rather than traditional litigation process. Most of the disputes have a technical nature and the affected parties prefer to get the support of a person having adequate skills, knowledge and understanding on that technical background to resolve the dispute.

The arbitration process in construction can be identified as a private method that binds parties to enforce a settlement. Further, it is considered as a part of a growing league of alternative dispute resolution procedures which compete with conciliation and mediation.

2.3.5 Conciliation

A neutral third party which is appointed by the parties to the disputes is involved in identifying the dispute, developing the options, considering the alternatives and persuading to reach an agreement during the process of conciliation. This can be identified as a process of dispute resolution with the agreement of both the parties in the light of consultation of conciliator.

The adversaries are brought together by a third party successfully in conciliation. The conciliator acts as a “host” to the negotiations and does not actively engage in the meetings. Simply, the conciliator’s

role is to bring the parties together and to reduce the rhetoric and counterproductive pre-negotiated attitudes of the parties (Mose & Kleiner, 1999).

When compared to the arbitration process, the conciliation has no legal standing and there is no authority to call witnesses or seek evidences by the conciliator. Moreover, this process does not write a decision and makes no award. Conciliation differs from mediation because the main goal is to conciliate, by seeking concessions. In mediation, the mediator guides the discussion to optimize party's needs considering their feelings into account while reframing the representations

2.3.6 Med- Arb

There is a pre agreement between the parties regarding how they first mediate a dispute. If they fail to reach a resolution through mediation, it is bound that dispute shall be submitted to arbitration. This method motivates to settle the dispute through mediation without carrying it to arbitration. Hence, after an ineffective mediation only, the process of arbitration shall come to the stage (Mose & Kleiner, 1999).

2.4. CRITICAL FACTORS OF SELECTING ADR METHOD

Cheung (1999) stated that, it is essential to consider some factors while selecting a suitable ADR method. These factors are demonstrated in the Figure 4. Miles (1992) identified a list of attributes in selecting ADR, including voluntariness, involvement of a third party, degree of formality, nature of the proceeding, outcome and privacy.

3. Research Methodology

Critical factors affecting to use of ADR

Ability to appeal if not satisfy with the result
Bindingness of the decision
Confidentiality of the process
Parties ability to control over the proceeding
Obtaining creative solution
Cost involved
Enforceability of the decision
Gaining Fairness
Flexibility of the proceeding
Preservation of relationship
Privacy of the proceeding
Third party helps to negotiate and narrow down the issues
Scope of remedy
Speed of the process
Providing a qualified, neutral expert to hear complex matter

Figure 4, Critical factors affecting to use of ADR

Expert interviews and detailed questionnaire survey were used as the main data collection methods throughout the study. Preliminary interview survey was carried out among the experts who have more than 20 years of experience and knowledge on construction claims, dispute resolution and contract administration in the Sri Lankan construction industry. Main objective of expert interviews is to validate and modify the information gathered in literature review from the Sri Lankan construction industry perspective. Conducting semi structured interviews were beneficial to the research as problems, confusions and distinctions arose in the process of interview were clarified during the interview.

With the results of the expert interviews a questionnaire was prepared focussing on construction industry professionals with more than 5 years of experience. Intention of the questionnaire survey was to identify the usage of the ADR methods in the Sri Lankan context and to identify the perception of contractors on ADR methods. Data gathered through questionnaire survey was also used in identifying

the significance of the factors consider in the selection of ADR methods. Having completed the data collection, content analysis method was used to analyse qualitative data and to analyse the quantitative data gathered from the questionnaire surveys Relative Important Index (RII) and Mean weighted rating were used.

4. Data Analysis

One objective of this study was to identify the degree of use of alternative dispute resolution methods in Sri Lanka. Based on the frequency of usage, it can be stated that Negotiation is the frequently used method in dispute resolution as 83% of respondents use it every time when dispute arise. Also, when it comes to the mediation 52% of the respondents never tend to use it as a dispute resolution method. According to the findings 100% of the respondents stated that arbitration is used occasionally for dispute resolution. According to the mean weighted rating, Negotiation got the highest ranking and Arbitration got the lowest. Table 1 significantly shows the frequency of usage of ADR Sri Lankan construction industry.

Table 34, Frequency of using ADR method

	Never	Occasionally	Every time	Mean Weighted Rating	Rank
<i>Negotiation</i>	0%	17%	83%	2.83	1
<i>Mediation</i>	52%	48%	0%	1.48	4
<i>Adjudication</i>	0%	35%	65%	2.65	2
<i>Arbitration</i>	0%	100%	0%	2.00	3

Identifying the perception of contractors on ADR methods practicing in Sri Lanka was another objective of the study. In order to identifying the perception on ADR, seven categories as awareness of the concept, awareness about procedure, awareness in related legislation and standard condition contract, level of satisfaction, settlement rate, duration of the procedure, cost involved in the procedure were evaluated.

Table 35, Mean Weighted ratings of perception factors of ADR methods

<i>ADR Method</i>	Awareness of concept	Awareness of procedure	Awareness of related legislation	Level of satisfaction	Level of settlement
<i>Negotiation</i>	3.00	3.00	2.83	2.87	2.83
<i>Mediation</i>	2.61	2.52	2.65	2.57	2.35
<i>Adjudication</i>	2.83	2.61	2.7	2.22	2.22
<i>Arbitration</i>	2.43	2.43	2.4	1.87	1.70

Almost all the respondents are aware of the concept of negotiation. Significant number of respondents are aware on mediation and adjudication concepts but relatively low percentage of respondents are aware on the concept of arbitration. The awareness level of procedure shows the same kind of result. It is important to identify the level of satisfaction of using each ADR method from the contractors' perspective. Study reveals that most of the respondents are having high satisfaction level when using negotiation and low level of satisfaction when using arbitration as the ADR method. Similarly, Negotiation has highest settlement rate and arbitration has the lowest, showing the contractors reluctant to use arbitration as an ADR method to resolve disputes in construction projects.

Third objective of this study is to find significance of the critical factors in selecting ADR methods. Factors identified through literature review were validated through the preliminary survey and then the significance was evaluated by using the results of the questionnaire survey. Five-point Likert scale was used to identify the importance of the factors. MWR and RII were used to evaluate and rank the factors. Results of each factor are illustrated in the following Table 3 and rankings based on RII values are shown.

Table 36, Factor Ranking

Factor Code	Critical Factor	Mean Weighted Rating	Standard Deviation	RII	Rank
A1	Ability to appeal if not satisfy with the result	3.130	0.968	62.61	11
A2	Bindingness of the decision	3.261	0.541	65.22	9
A3	Confidentiality of the process	3.739	0.449	74.78	5
A4	Parties ability to control over the proceeding	3.217	0.736	64.35	10
A5	Obtaining creative solution	3.087	0.668	61.74	13
A6	Cost involved	4.435	0.507	88.70	2
A7	Enforceability of the decision	3.739	0.449	74.78	5
A8	Gaining Fairness	3.652	0.487	73.04	7
A9	Flexibility of the proceeding	3.783	0.422	75.65	4
A10	Preservation of relationship	4.217	0.600	84.35	3
A11	Privacy of the proceeding	3.348	0.487	66.96	8
A12	Third party helps to negotiate and narrow down the issues	3.043	0.209	60.87	14
A13	Scope of remedy	3.130	0.757	62.61	11
A14	Speed of the process	4.609	0.583	92.17	1
A15	Providing a qualified, neutral expert to hear complex matter	2.957	0.367	59.13	15

Speed of the process get higher ranking in the list. According to the results of the mostly used ADR method, negotiation became the number one because of its quicker process. Therefore, it is reasonable to have a higher ranking for the speed of the process.

Providing a qualified, neutral expert to hear complex matter ranked as the lowest important factor in selecting ADR method. As mentioned by the contractors, industry is lack of experts and most of the time the other party disagree with the qualification of the expert. So, contractors are not much considering about the third party. Second ranked factor is cost of the process. ADR was initiated as quicker and economical process when it compared with the court proceedings. According to the contractor's perception third important factor is preservation of relationship. Preservation of relationship is important because contractors need well established relationships with stakeholders in the industry to survive and to preserve future opportunities. Flexibility of the proceeding became the fourth important factor. Flexibility of the proceeding is very important to contractors when fixing the proceeding dates and submission dates.

Confidentiality and Enforceability of the process achieved fifth rank in the list. Gaining fairness from the decision is the next ranked factor. Privacy of the proceeding, Bindings of the decision and Parties ability to control over the proceeding are in order getting 8th, 9th and 10th places. It is significant that binding of the decision is ranked in 9th place. But it is mentioned by some contractors as a problem of using ADR in Sri Lankan construction industry. Scope of the remedy and the Ability to appeal both ranked in 11th in the list. Obtaining creative solution and involvement of third party are not much considered by the contractors.

4. Conclusion

Negotiation, Mediation, Adjudication and Arbitration were identified as the ADR methods that are popularly used in Sri Lanka and among those methods Negotiation is the mostly used method by the contractors. Further, it was found out majority of the respondents' have a high awareness level in concept, procedure and legislation of negotiation and adjudication, and less awareness level on Arbitration. Though mediation is not frequently used in the Sri Lankan construction industry, from the contractors' perception, mediation have substantial satisfaction level than Adjudication and Arbitration. Similarly, negotiation has highest settlement rate and arbitration has the lowest settlement

rate than mediation and adjudication. From the contractors' point of view speed of the process is the most critical factor when selecting a suitable ADR method. Cost involved, preservation of relationship and flexibility of the proceeding are also highly considered during the selection of the best ADR method.

5. References

- Abeynayake, M. D. T. E. (2014). *Critical analysis of Alternative Dispute Resolution Methods used in the Construction industry in Sri Lanka*. University of Moratuwa.
- Abeynayake, M., & Weddikkara, C. (2013). Special Features and Experiences of The Full- Term Dispute Adjudication Board As An Alternative Dispute Resolution Method In The Construction Industry Of Sri Lanka. *International Conference on Building Resilience Heritage Ahungalla, Sri Lanka, 17th -- 19th September 2013*, 1–14.
- Andoh, K. B. (2010). *Disputes in construction project preventing, managing, resolution*.
- Arthur, B., & Marriott, L. (1999). *ADR principles and practice 2nd ed*. London: Sweet & Maxwell.
- Blain, N., Goodman, J., & Loewenberg, J. (1987). Mediation, Conciliation and Arbitration - An International Comparison of Australia, Great Britain and the United States. *International Labour Review*, 126. Retrieved from <http://heinonline.org/HOL/Page?handle=hein.journals/intlr126&id=193&div=&collection=>
- Bruni, A. (2012). Mediation as an Alternative Dispute Resolution Method. In *European Mediation Training for Practitioners of Justice* (pp. 15–25).
- Cheung, S.-O. (1999). Critical factors affecting the use of alternative dispute resolution processes in construction. *International Journal of Project Management*, 17(3), 189–194. [https://doi.org/10.1016/S0263-7863\(98\)00027-1](https://doi.org/10.1016/S0263-7863(98)00027-1)
- Cheung, S. O., Yiu, T. W., & Yeung, S. F. (2006). A Study of Styles and Outcomes in Construction Dispute Negotiation. *Journal of Construction Engineering and Management*, 132(8), 805–814. [https://doi.org/10.1061/\(ASCE\)0733-9364\(2006\)132:8\(805\)](https://doi.org/10.1061/(ASCE)0733-9364(2006)132:8(805))
- Emuze, F., & Isa, R. (1999). Stakeholders' Perceptions of Construction Dispute Resolution Mechanism in Nigerian Construction, 0–12.
- Gill, A., Gray, J., Skitmore, M., & Callaghan, S. (2015). Comparison of the effects of litigation and ADR in South-East Queensland. *International Journal of Construction Management*, 15(3), 254–263. <https://doi.org/10.1080/15623599.2015.1066568>
- Gould, N. (2004). Dispute Resolution In The Construction Industry. *Construction Law Seminar: Introduction to the Basics 2004*, (September), 34. <https://doi.org/10.1016/j.jclepro.2010.04.022>
- Harmon, K. (2003). Resolution of Construction Disputes: A Review of Current Methodologies. *Leadership Management Engineering*, 3(4), 187–201.
- Kubal, T. (1994). Engineered quality in construction. Partnering and TQM. Retrieved from <https://trid.trb.org/view.aspx?id=405313>
- Lathem, M. . (1995). *Constructing the Term*. United Kingdom.
- Levy, S. M. (2007). *Claims, Disputes, Arbitration, and Mediation. Project management in Construction, 5th Edition by McGraw-Hill Companies*. <https://doi.org/10.1080/014461983000000015>
- Loosemore, M. (1999). Responsibility, power and construction conflict. *Construction Management and Economics*, 17(6), 699–709.
- McMurtry, B. (2012). Advantages and Disadvantages of Dispute Resolution Processes. *Blaney.Com*, 3. Retrieved from https://www.blaney.com/sites/default/files/other/adr_advantages.pdf
- Mose, D., & Kleiner, B. (1999). The emergence of alternative dispute resolution in business today. *Equal Opportunities International*, 18(5), 54–61. <https://doi.org/10.1108/02610150810844965>
- O'reilly, M. P., & Mawdesley, M. J. (1994). *The evaluation of construction disputes: a risk approach*. Blackwell publishing.
- Oshodi, S. O., & Ejohwomu, O. A. (2014). Causes of conflicts in construction projects in Nigeria: Consultant's and Contractor's perspectives. *Proceedings of the CIB W107 2014 International Conference*, 35(2), 325–333.
- Pagone, G. (2008). Litigation and ADR . In *Construction Law Conference*. Melbourne.
- Ranasinghe, A., & Korale, J. . (2011). Adjudication in Construction Contracts. *Engineer*, XXXIV(2), 73–82.
- Skitmore M, W. J. (1994). Estimating Processes of Smaller Builders. *Construction Management and Economics*, 12(2), 139–154.
- Spittler, J. R., & Jentzen, G. H. (1992). Dispute resolution: managing construction conflict with step negotiations. *AACE International Transactions*, 9.1-9.10.
- Steen, R. H. (2002). Alternative Dispute Resolution in the Construction Industry. *New Jersey State Bar Association's Dispute Resolution*.
- Van der Merwe, C. J. (2009). *Is adjudication a better procedure for construction dispute resolution than mediation?*
- Yusof, A. M., Ismail, S., & Chin, L. S. (2011). Procurement Method as Conflict and Dispute Reduction Mechanism for Construction Industry in Malaysia. *International Proceedings of Economics Development & Research*, 15, 215.

Samarawickrama, Sumanthri, et al (eds), 2018, "Sustainability for people - envisaging multi disciplinary solution": *Proceedings of the 11th International Conference of Faculty of Architecture Research Unit (FARU), University of Moratuwa, Sri Lanka, December 08, 2018* Galle pp. 465-481 ©

PRODUCT USABILITY OF UTENSILS USED IN NASYA KARMA OF SRI LANKAN INDIGENOUS MEDICINE; WITH SPECIAL REFERENCE TO THE GOKARNA YANTRA

UDARI MOHOTTI¹ & DILSHANI RANASINGHE²

^{1,2}Department of Integrated Design, University of Moratuwa, Sri Lanka

¹uam093@gmail.com, ² dilshaniranasinghe80@gmail.com

Abstract

The practice of Sri Lankan Indigenous Medicine is highly acknowledged for its many special benefits with respect to Allopathic (Western) medicine. It is a system of medicine that has one main target; to cure an illness not just temporarily, but from its root itself. Each treatment process has its own unique procedure to follow- from the material (herb) used to its method of preparation to its consumption. But since the knowledge of Sri Lankan indigenous medicine was mainly handed down from generation to generation while jealously guarded from other practitioners, with the decline of certain ancestries, their secret ingredients have sometimes failed to be passed on. One such component lacking information is the usage of containers and utensils. The design of medicinal containers and utensils is an area which needs a special focus, since it deals with many aspects with regard to the human. While the main focus of producers of medical equipment would be the material usage, chemical reactions and enhancement of the medical value, a very important area that is seldom discussed is the product experience and psychology of the user. While the indigenous medical practitioners of Sri Lanka do not appear to have paid conscious attention to the usability of a product, they have been able to last through centuries and also attract a large group of patients, irrespective of the utensils used. This is commonly seen in Panchakarma treatments, especially Nasya Karma (Nasal Instillation). This research aimed to understand the thinking and rationale behind the designing and choosing of the utensils in Sri Lankan Nasya Karma and analyze the product psychology and usability aspects in them. The Gokarna Yatra used in Nasya Karma is using both physical and psychological data collected through both quantitative and qualitative methods. The ancient Gokarna Yantra displayed at National Museums in Sri Lanka and those hereditarily used by current practitioners were analyzed during the study. These objects were analyzed in terms of their physical factors under the Form and Aesthetics. The human factors of the products were analyzed under the Attribution of Meaning and Emotional Responses.

Keywords: *Product Psychology, Product Usability, Design Considerations, Nasya Utensils, Sri Lankan Indigenous Medicine*

1. Introduction

Since ancient times, man has had the practice of finding objects and products to support their tasks. As a result, many inventions were made, bettering and quickening their day-to-day activities. These products have gone through many changes with the times, cultures, knowledge, availability of material and preferences. Therefore, it can be observed that human-product interaction has existed since ancient times.

Today, product design is a process that is taught at design schools. Products are designed based on research on user needs, and enriched by knowledge in design, technology, science, etc. Therefore, most modern product designs are successful in the case of customer satisfaction and in sustaining in the market. But observation and research show that products that have been created and used long before the birth of design schools have extremely successful and satisfactory characteristics too. These products have not only fulfilled man's purposes successfully, but also managed to remain for a long time throughout history. How ancient people or 'designers' obtained this level of customer satisfaction remains a mystery, and therefore several researches have been conducted to understand the design

thinking behind some of these products. One such field where ancient products have sustained for a long time is the field of medicine.

Medicine is the practice of diagnosing, treating and preventing of disease (Definition of Medicine and Clinical Practice, 2005). It involves a variety of health care related practices that involve ways of maintaining and restoring health, by preventing and treating disease. The field of medicine has gained utmost importance in every culture and society since the most ancient times. It has existed for over a thousand years; not necessarily as a form of science, but often at least as a form of art, religion or philosophical culture. The medicine that was born before scientific involvement is generally known as traditional medicine, indigenous medicine or folk medicine.

Each country and culture have their own approaches to medicine, whether mixed with other practices or independently formed. Research has shown that Sri Lanka too has a history of powerful and highly admired medicinal practices. Created and shaped with our indigenous knowledge and the availability of materials, and then adapted and reformed with the influence of other cultural integrities, Sri Lanka's indigenous medicine comes a long way in history (Uragoda C. G., 1986).

Although the currently dominant medical system in Sri Lanka is Allopathic (Western) medicine, Indigenous medicine like Ayurveda is also practiced widely around the country, gaining good recognition. While Allopathic medicine is known to give quick and satisfactory results, it is a common belief acknowledged among Sri Lankans that our Indigenous medicine can cure most diseases and ailments to its core (Times, 2016). It is often heard that where certain Western medications failed, our indigenous medicine has been known to cure certain illnesses. Thus, even with the embracement of Allopathic medicine, we can see an increasing tendency to go back to Indigenous medical solutions, especially among people of the older generations.

This paper aims to discuss the background of the field of Indigenous Medicine in Sri Lanka, the importance of conducting research and recording the information, before the complete dissolution of the system, and to discover the reasons behind the sustainability of the products related to Sri Lankan Indigenous Medicine.

There is hardly any information available on the state of medicine in the pre-historic times of Sri Lanka, but there are several implications available in Folk stories that have been recited over the generations. One such important story in Sri Lanka is that of the pre-historic Sri Lankan king, Ravana. It is traditionally believed that King Ravana, of the famous tale of Ramayana, was well versed in medical lore. Some versions of this folk story mention that he represented Sri Lanka at a medical conference in India, and it was during this that he met the beautiful princess Seetha, which led to the first Indo-Sri Lankan conflict. Ravana is also believed to have been the author of several books on medicine, namely Arkaprakasaya, Nadivignanaya, Kumarathanthraya, and Udishasasthraya. (DeSilva P. L., 2006; Uragoda C. G., 1987).

The most recorded stage of history in Sri Lanka that has information on medicinal practices is the period under royal patronage. Information on the monarchy period of Sri Lanka is available in Rock Inscriptions, books like the Mahawamsa and traditional stories. These information states that during this period, the King of the country was also compulsorily a physician. The main examples are stories on King Dutugemunu (161-137BC), King Lajjatissa (119109BC), King Walagamba (89-77AD), King Kashyapa IV (912-929 DC) and King Parakramabhahu II (Ramanayake, 2016; Samara, 2008; DeSilva P. L., 2006; Uragoda C. G., 1987). Up until the 13th Century BC, Indigenous medicine of Sri Lanka has flourished under the royal patronage. The knowledge and practice of Sri Lankan medicine was known to have declined only with the impact of colonial domination. (Importance of Research in Ayurvedic Medicine; DeSilva P. L., 2006; Uragoda C. G., 1986).

Indigenous medicinal practices of Sri Lanka consist of four main sub-categories: Deshiya Chikitsa, Ayurveda, Siddha and Unani medicine. While different families originally practiced different medicine, with time these practices have diffused to form a set of merged medicinal practices. Though they are of various origins, they all had one target; to cure an illness not just temporarily, but from its root itself.

((Deraniyagala, 1953; E Heinz; Muller-Dietz, 1975; Johnston, 1827; Ismail, 1985; Uragoda C. G., 1986; Uragoda C. G., 1987; DeSilva P. L., 2006; Samara, 2008). Therefore for further purposes, the combined practice of traditional medicine in Sri Lanka will be referred by the name 'Ayurveda' in the research.

One main area of treating the body in Sri Lankan Ayurvedic practices, is the practice of 'Panchakarma Treatments'. Panchakarma is a purification therapy used in Ayurvedic medicine. "Pancha" means five and "karma" means treatment; the word panchakarma means five actions or procedures intended to intensively cleanse and restore balance to the body, mind, and emotions. It is a detoxification treatment involving massage, herbal therapy, and other procedures. It is done in the aim of detoxifying the body or "eliminating the vitiated Doshas" from the body. The five branches of Panchakarma are Vamana (Emesis), Virechana (Purgation), Niroohavasti (Decoction Enema), Nasya (Nasal Instillation) and Anuvasanavasti (Oil Enema). (Tiwari, 1998; Archana Singh Vishen; Meenakshi; Uttamkumar Sharma; Brijendra Singh Tomar, 2017). This paper will be discussing the utensils used in one of the above therapies; Nasya Karma (Nasal Instillation of Medicine) in Sri Lankan Traditional Medicine.

2. *Nasya Karma* and the Utensils Associated with Its Practices

Nasya is a treatment in which herbal extracts in the forms of juice, powder or pastes are administrated through the nose, typically to promote the relaxation and cleansing of the nasal cavities. Since the nose is considered the direct path to the head, it is considered to be one of the quickest and most effective methods of treatment, especially for many kinds of headaches, paralysis, mental disorders, some kinds of sinusitis, migraine catarrh and epilepsy. (Tiwari, 1998; Ayurvedic, 2014; Siddhalepa, 2018; Brihami, 2018). As a method of treatment which makes use of almost every form of medication in Ayurvedic practices- juice, powder, paste, etc- Nasya Karma requires the use of many utensils for different purposes.

As a treatment that involves direct interaction of medicine with the nose and head, Nasya treatments require great attention to precision and detail. While proper treatment can give miraculous results, a small mistake may be enough to trigger large complications such as Coma, Paralysis or even Death. (Martand, 2018; Siddhalepa, 2018) Therefore, while only highly experienced practitioners conducted these treatments since history, utensils were required based on precision and high usability. Though a wide range of utensils are believed to have been used for Nasya Karma by ancient practitioners, there are very few that can be found in current practices. The usage of these utensils in the beginning may have been influenced by the social status, cultural beliefs, availability of material, availability and knowledge on crafting skills, specialty of the practitioner, geographic locations and limitations, etc. While no scholarly accepted categorization is available for the utensils used for Nasya treatments, this research uses an author-defined classification based on the form of treatment, developed with the support of current practitioners of Indigenous Medicine in Sri Lanka.

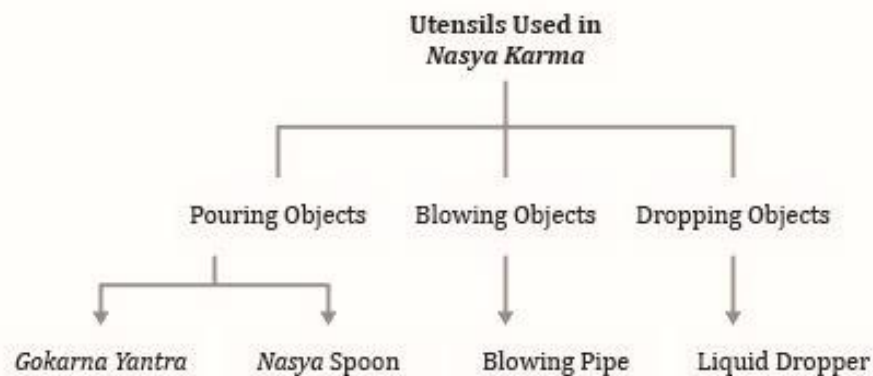

Figure 1: Classification of Nasya Utensils (Author's Creation)

Based on the above classification, objects were collected from Sri Lankan National Museums and current practitioners of Indigenous Medicine. Based on the availability of sources, the preferences of the interviewed practitioners & patients, the *Gokarna Yantra* will be discussed in this paper.

2.1. Users of *Nasya Upakarana*

Since this research is based on a Usability Analysis, the other main component to be considered is the User of the Product. While the general user of all Indigenous Medicinal Utensils is the Veda Mahattaya (Traditional Doctor), *Nasya* objects have another special feature; it has two main groups of users. As a group of utensils that directly interact with the patient, the patient too must be considered a User of the products. Sri Lankan Ayurveda practices have been successful in upholding a high reputation for hundreds of years. Even today, there are numerous cases where people are known to have obtained unbelievable results through Ayurvedic treatments, whenever Western medicine has failed. These cases of astonishing treatments have also been supported by the unbreakable reputation upheld by the Sinhala Veda Mahattaya (Sinhala Doctor) since ancient times.

2.1.1 Veda Mahattaya (Traditional Doctor)- User Group 01

An incomparably prestigious position in the ancient Sri Lankan society, the Veda Mahattaya (Traditional Doctor) has always been considered a miracle-worker. He was known to walk everywhere with his Beheth pettiya (Medicine casket), in case he met someone on the way who needed his help. Placed in a hierarchical position only second to the King and his immediate team, the Veda Mahattaya has been a status that was mainly powered by the blood line. The status of the Veda was handed down from one generation to the next, generating a competition between different teachings, based on the unique treatment techniques and specialties. Therefore, most knowledge were only passed down from father to son, and sometimes with the end of a bloodline, some knowledge have ceased to exist. Currently there are very few Veda Mahattayas who practice medicine as passed on by older generations, while there are new practitioners who have studied the teachings of modern Ayurveda, introduced essentially by India.

2.1.2 Patients- User Group 02

The patients of Indigenous Medicine in history would have been the general public, who sought advice and treatment from the Veda Mahattaya whenever needed. The doctor would have been chosen either as nearest to the occasion or in a habitual process (similar to the concept of the 'family doctor'). Currently, patients of Indigenous Medicine are mainly under several categories; the elderly who are habitual patients and their younger

19

generations, friends advised by satisfied patients, patients seeking options after the fail of Western medical treatments, etc.

2.2 Method of Analysis

The sample group for observation and interviews were selected based on the above two user groups (as discussed in 3.2). The data gathered from these interviews and observation were organized based on an author-developed framework, for the benefit of analysis. The framework was developed based on the studies and classifications discussed in Desmet, Hekkert (2007) and Desmet (2010). As discussed in 2.4.1 and 2.4.2, the various classifications of Usability, Product Emotion, and User-Product Interaction were considered, and the path to a "good product experience" was categorized under three main stages as:

1. Form and the Aesthetics
2. Attribution of Meaning
3. Emotional Response and Pleasantness

The Usability and Experience of a product will be analyzed individually in this research by considering each of the three stages mentioned above. The balanced experience of all three stages would be the perfect experience as shown in Figure 2 below:

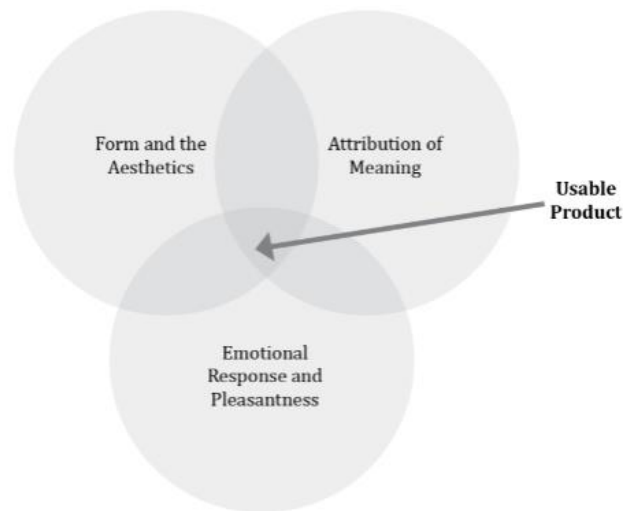

Figure 64: Framework of Product Usability Analysis (Author's Creation)

3. Gokarna Yantra

The Gokarna Yantra is a small oil lamp like structure, with a relatively long handle and an elongated pour spout. The bulbous body of the object holds the medicine inside, while the spout which extends from the body controls the flow of liquid. It is a hand-held device with a handle with several variations. The name Gokarna Yantra has been derived from the words 'Gona' (Bull) + 'Ana' (Horn), meaning bulls horn (Samarakoon, 2018). This name is believed to have been originated from the shape of the product, which is basically similar to the shape of the horn of a bull. In certain contexts, the Gokarna Yantra is also referred by the name 'Nasya Patra' (Indiamart, 2018).

The Gokarna Yantra is mainly used to pour oils, herbal extracts and other liquid medicines into the nose: "Then the physician lifted the tip of the nose of the patient with fore-finger of his left hand and 4 Bindu (240µl, i.e. 0.24 ml) of Lakshyadi Taila was slowly poured stream like a manner into the patients each nostril by Gokarna Yantra with his right hand, patient asked to snuff the medicine, care was taken that the medicine would not get into the eyes during the Nasyavidhi." (Martand, 2018).

The Gokarna Yantra is intended to be used for one nostril at a time (Nair, 2010; Martand, 2018). It has been initially made of Brass or other rich metals, with decorations and details finely crafted. Currently, the type of Gokarna Yantra found among practitioners is a simpler form made of brass, mostly imported from India.

There are several variations of the Gokarna Yantra used by different practitioners. Some have very unique features and are highly crafted, which may be to depict the social status maintained by the practitioner and also because they are made for personal use only. The more modern versions of the Gokarna Yantra are simpler in form and appear to have been made considering mass production, in all aspects including material, weight, size, etc.



Figure 65: The decorative Gokarna Yantra displayed at the Koggala Martin Wickramasinghe Museum (© Martin Wickramasinghe Trust Fund, 2018)



Figure 66: The Nasya Patra imported to Sri Lankan Ayurvedic practitioners
(Source: <https://www.indiamart.com/superfinebrasshouse/brass-nasya-patra.html>)

3.1. Form & Aesthetics

The Gokarna Yantra is typically used for pouring oil and medical extracts into the nose, by holding onto the stem/handle and letting the liquid drip along the long spout into the nose. Therefore, the basic requirements of a product for this purpose are the spout, handle and body of the product. In some cases, a foot/base also is available.

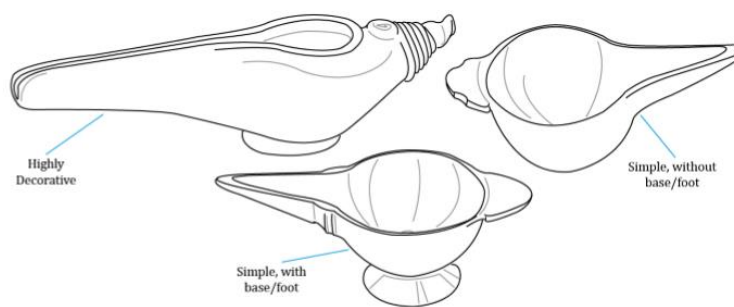

Figure 67: Basic Variations of Form (Source: Author)

There are many variations of the Gokarna Yantra, but for the purpose of easy analysis, the many variations were grouped under the two types; the highly decorative object displayed at the Koggala Martin Wickramasinghe National Museum and the simple and flat-topped objects used by current practitioners and Ayurvedic spas- with a base or without a base (as shown in Figure 5 above). The following speculations and analysis will be based on these two types.

3.1.1 Handle

The handle of the Gokarna Yantra is generally held between two or three fingers. Sometimes the other fingers are used for support, but the basic grip is powered by the thumb, index finger and sometimes the middle finger too. The shape of the handle is usually a form developed from a basic cone or disk.

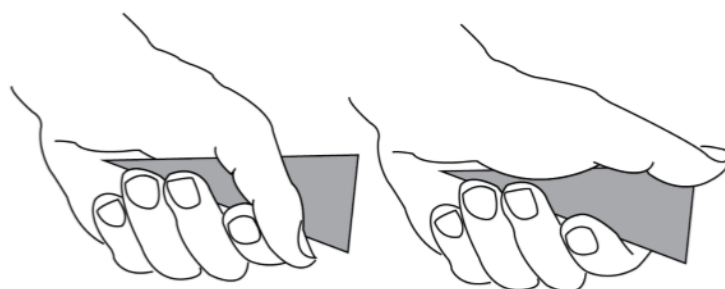

Figure 68: Basic Power Grip Applied on a Conical Handle (Source: Author)

The conical handle was found only in the most ancient Gokarna Yantra which is believed to have belonged to the 6th Century, displayed at the Koggala Martin Wickramasinghe Museum. The conical handle helps to keep a firm power grip on the object, preventing slipping and enhancing precision during usage. This may have been due to the hurry of the doctor, who rarely used support from another person during treatments, and needed a firm grip on one hand while he conducted other treatments with the other hand.

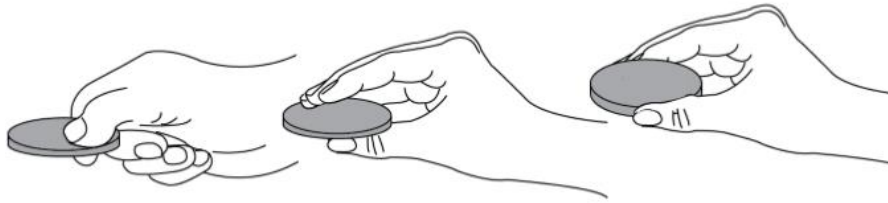

Figure 69: Basic Pinch Grip Applied on a Disk-like Handle (Source: Author)

3.1.2 Spout

The spout of almost every Gokarna Yantra is similar to each other, varying slightly for example by the open angle at the tip. Basically, having a conical or semi-conical form, the spout is designed to gradually decrease the flow of liquid to drip in the form of droplets. Since the amount of medicine is measured by droplets, it is important that the liquid flow is controlled. This is obtained by the gradual decrease of circumference of the cone, starting from the body of the object to the tip.

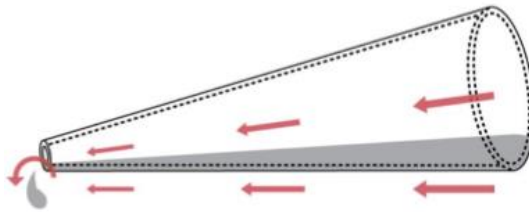

Figure 70: Liquid Flow from Conical Spout (Source: Author)

Since the liquid in the Gokarna Yantra is used by slightly tipping the object when needed, the angle of tipping too may affect the control of liquid flow. While there are no defined standards for the angles for tipping the Gokarna Yantra during use, the main variations of the spout that can be observed are the angle of the opening at the tip. The tip of the conical shaped spout in complete form would be a hollow cylindrical form. But every Gokarna Yantra uses the spout without the part of this form. The main variation that can be observed in the Gokarna Yantra that were analysed were in the angle of opening. The oldest Gokarna Yantra had smaller openings (higher degree of the tip is available). With the limited amount of liquid stored in this object, a reasoning is unclear for using a small opening, except for the possibility of considering the aesthetic factor (Figure 9).

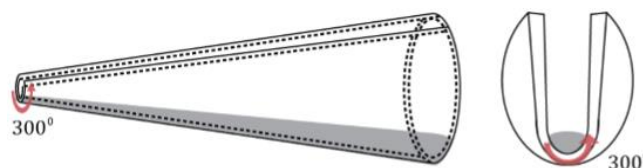

Figure 71: Spout of the Gokarna Yantra at the Koggala Martin Wickramasinghe Museum (Source: Author)

The newer versions had higher openings, making it an exact semi-conical form. This too may have been due to the aesthetic factor, since the body of the object too is a definite hemisphere, but it also may have been to reduce the material usage. This conclusion can be drawn with the tendency of the modern

versions to consider mass production. Since very little liquid will be available in the space, it could be believed that the modern versions have used a form which uses the minimal amount of material to serve the purpose (Figure 10).

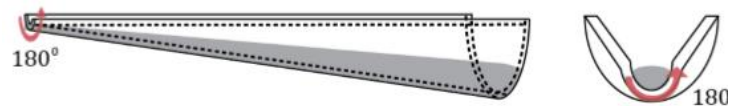

Figure 72: Spout of a Modern Gokarna Yantra (Source: Author)

3.1.3 Detailing

Other than the above discussed parts of the *Gokarna Yantra*, there are small details of the product that have been used to enhance the functionality of it. Some of these details are not common to one another, and therefore cannot be compared. Some examples of such details are the foot/base of the object, mouth of the object, decorative elements, etc.

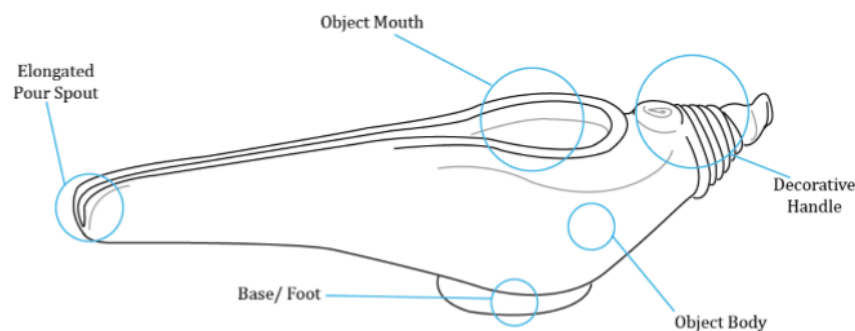

Figure 11: Parts of the Gokarna Yantra displayed at the Koggala Martin Wickramasinghe Museum (Source: Author)

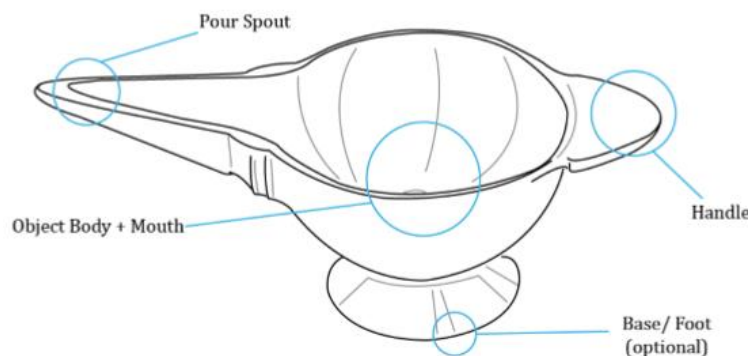

Figure 12: Parts of a Modern Gokarna Yantra (Source: Author)

3.1.4 Base/ Foot

The base of the *Gokarna Yantra* is an optional feature, since it is not compulsory to the main function of the product. But 80% of the *Gokarna Yantra* that were observed in this research had a foot. While the most general reasoning for having a foot is that it was intended to be placed erect on a flat surface, several interviewees had more diverse opinions. One such reasoning is that it would optimize the time spent, by being able to quickly place it on the table before and after use when switching between tasks. Another believed it was to balance the liquid inside naturally to avoid spillage.

3.1.5 Object Body & Mouth

All *Gokarna Yantras* have an open mouth with no lid. This may be because it is used once per treatment and has no requirement to store the liquid within before or after. The proportion of the object body that is open as its mouth may vary, according to the shape of the object. The ancient *Gokarna Yantra* of the Koggala Martin Wickramasinghe Museum has a comparatively smaller opening as the object mouth. With its unique body form and great attention paid to decorative elements, it may be due to aesthetical reasons, since there is a big unused space of the object body once liquid is poured to its maximum level.

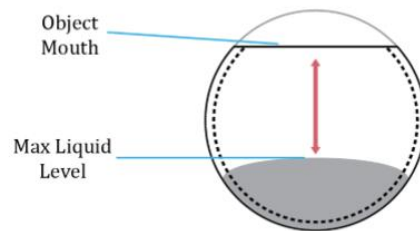

Figure 13: Object body & Mouth of Ancient Gokarna Yantra (Source: Author)

The mouth of the modern Gokarna Yantra is placed much lower than the older one. Once liquid is poured to its maximum level, the gap between the object mouth and the liquid is very low, thereby wasting very little space. With its simple and minimalistic design, it could be derived that the object mouth is placed in such a way that the maximum space is utilized by a minimal design.

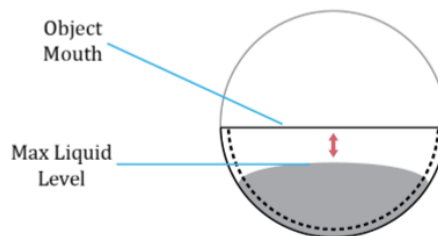

Figure 14: Object body & Mouth of Modern Gokarna Yantra (Source: Author)

3.1.6 Decorative Elements

In general, the *Gokarna Yantra* is a very aesthetically designed object. Old or modern, the level of decoration may vary, but as a medical instrument, the *Gokarna Yantra* is relatively more aesthetically pleasing.

The ancient *Gokarna Yantra* of the Koggala museum can be observed to have paid higher attention to aesthetic detailing than the more modern ones. The basic form itself is more organic and feminine in its appearance. The use of material is almost similar, but in the ancient objects, the material is used in a denser form, giving it a more 'rich look'. The modern objects too are curvy and aesthetically pleasing for a medical instrument but are less dense in the use of material and much simpler.

While most parts of the *Gokarna Yantra* appear to simply have been aesthetically designed, when analysed further they appear to have more functional insights too. These will be discussed elaboratively in section 3.2.

3.2. Attribution of Meaning

As discussed in section 3.4.1, the *Gokarna Yantra* is an object which appears to have paid high attention to detailing. While some elements initially appear to be aesthetic details, when analyzed, they appear to have more space for functional interpretations. Figure 15 & Figure 16 show a general overview of few such details of the *Gokarna Yantra*.

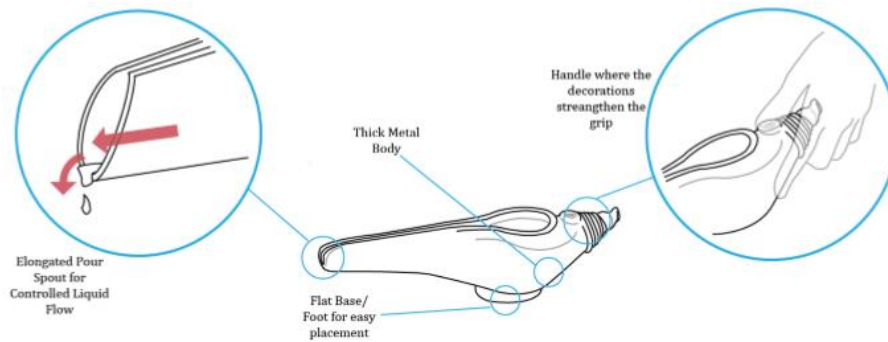

Figure 15: Aesthetic Detailing of the Ancient Gokarna Yantra (Source: Author)

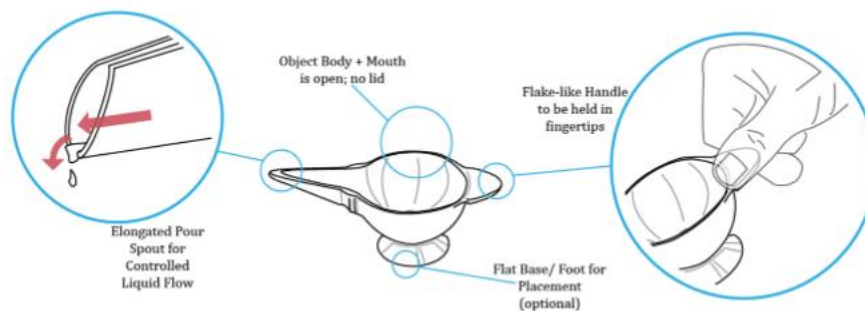

Figure 16: Aesthetic Detailing of the Modern Gokarna Yantra (Source: Author)

As a study on usability of these objects, it is of utmost importance to study the general semiotics of the objects. Even though the general usage of the *Gokarna Yantra* can be considered simple, it must be used with great precision. Therefore, each detail, aesthetic or not, must serve some functional purpose instead of distracting the user from its main objective. It can be said that in order to obtain the maximum efficiency of the product, the form and function both are equally important.

While most of the parts of the *Gokarna Yantra* were discussed earlier under section 3.1, this section would pay more attention to the different interpretations that can be made of the different parts of the object.

3.2.1 Method of Holding

During the series of interviews and observations conducted in this research, the first group of interviewees (doctors/practitioners) were requested to hold the two types of *Gokarna Yantra* (Figure 5). 35% of the interviewees had never used a *Gokarna Yantra* before; they sought to modern alternatives like the rubber suction dropper used in Western medicine. No indication as to how it is held was mentioned, and the interviewees were expected to hold the object based on their observations, previous practices or guesses. There were several variations of the way these objects were held by different interviewees, and a basic summary is shown in Figure No. 17 below:

Whether they had used a *Gokarna Yantra* before or not, every interviewee experimented the way of holding the two objects by considering the method of usage; how the liquid is poured into the nostril. While the interpretations varied and overlapped in many cases, the most common variations are mentioned in Figure 17 above. The detailed variations of interpretations in different parts of the *Gokarna Yantra* are discussed in the following sections.

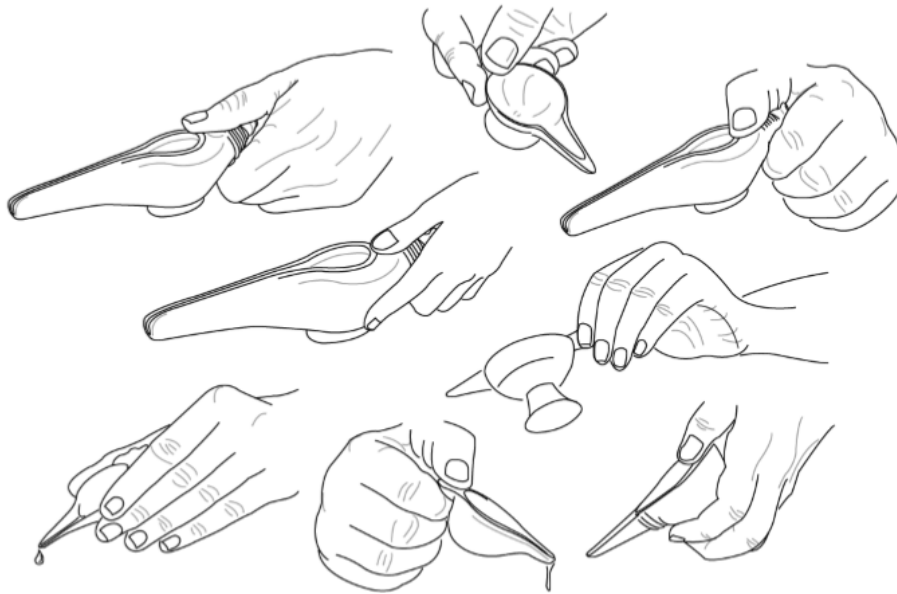

Figure 17: Different Ways of Holding the Gokarna Yantra (Source: Author)

3.2.2 Handle

The handle is the part where most of the variations in interpretations occurred. Since it is a hand-held device, the handle of the object plays a very important role in its optimum usage.

The general form and functionality of the handle of the *Gokarna Yantra* were discussed in section 3.4.1.1. This section pays attention to the variation of interpretations that can be made of the previously discussed handles, and its usefulness and rightfulness.

The handle of the ancient *Gokarna Yantra* displayed at the Koggala National Museum, as shown in Figure 6 is based on a conical form. But when higher attention is paid to detailing of the handle, the mid part of the conical shape appears to be formed out of small rings, gradually decreasing in diameter to form a cone. While this may have been simply for aesthetic reasons, 82% of the interviewees believed that it was for a better grip too:

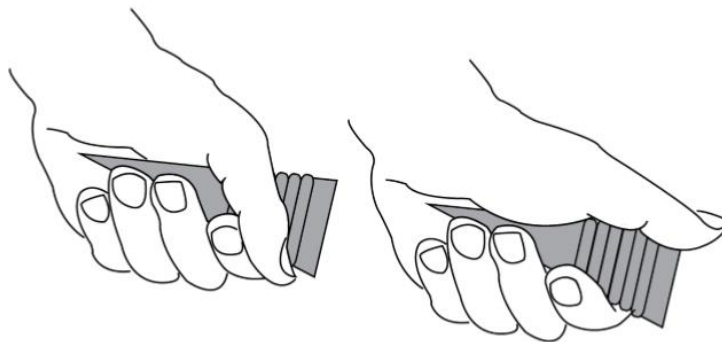

Figure 18: Actual Power Grip Applied on the Conical Handle (Source: Author)

As shown in the above Figure 18, when applying to the power grip discussed in Figure 6, the ring-like detailing appears to enhance the grip. Since the conical handle must be gripped tightly to avoid any slippage, the slight cuts formed by the ring-like features provide friction between the handle and the fingers. The points of contact made between the fingers and fractioned grip are almost full fingers, ensuring a very strong and powerful grip as shown in Figure 19:

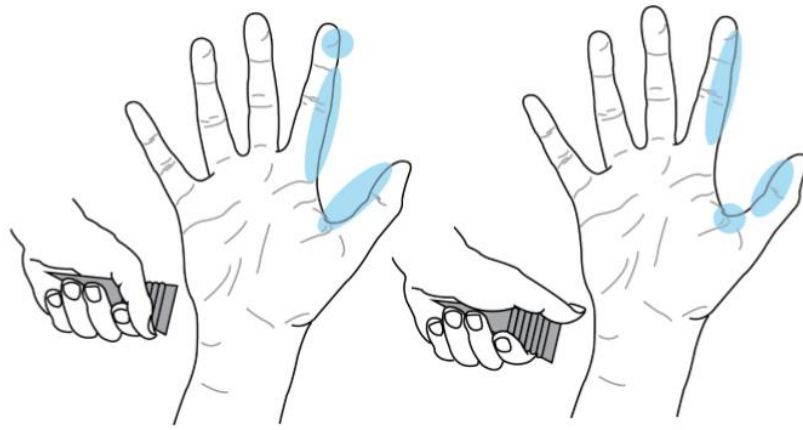

Figure 19: Points of Contact during Power Grip of Conical Handle (Source: Author)

The grip of the modern *Gokarna Yantra* too had a variation of interpretations related to the handle. Fabricated from a disk-like basic structure, there are several variations of the detailed handle. While some handles in plain view are an exact semi-circle, some have tiny organic shaped curves. During the interviews, the main observation was that the simple semi-circled handle was held vertically, and the handle with small cuts was held horizontally, by placing the thumb and index finger slightly pressing on the two cuts:



Figure 20: Actual Pinch Grip Applied on the Disk-like Handle (Source: Author)

Unlike in the old *Gokarna Yantra*, which requires a large area of contact in order to fasten the grip, the modern version has very few contact areas to be held steadily (Figure 21). The handle was often held using only the fingertips, even though there are no direct indications on the object to do so.

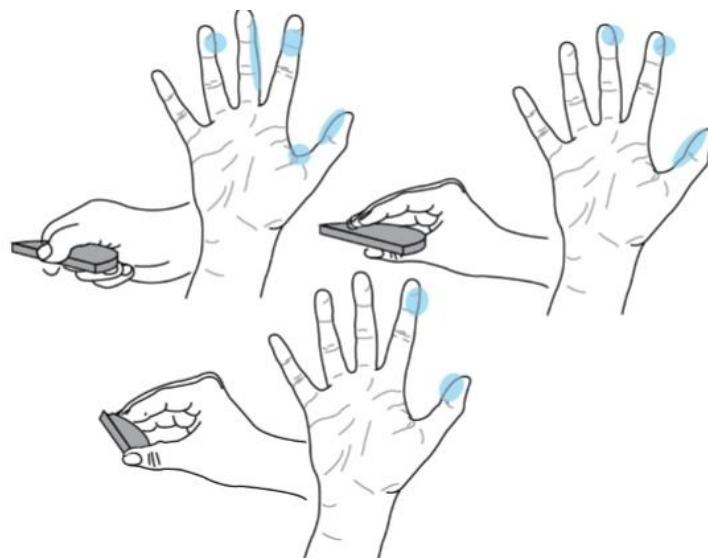

Figure 21: Points of Contact during Pinch Grip on Disk-like Handle (Source: Author)

3.2.3 Thumb Piece

While the entire object itself appears aesthetically designed, there are small parts that seemed to be placed with more than just aesthetic intentions. One such part is the small round part available near the largest ring of the handle of the ancient *Gokarna Yantra*. Another set of small rings merged vertically to form a small bump on the handle, 75% of the interviewees attributed its purpose as a thumb piece to tighten the grip. The ways of holding before emphasizing attention to this part varied in two ways:

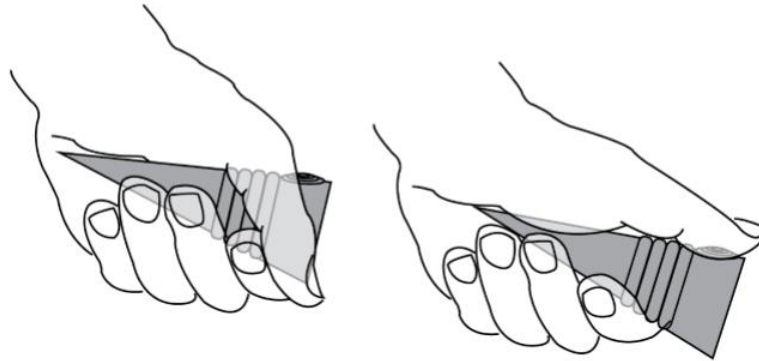

Figure 22: Different Interpretations of the Thumb Piece (Source: Author)

Both the above ways of holding the handle enhanced the grip, due to the position the 'thumb piece' was positioned. The thumb piece was generally positioned in a part of the hand that tightened the grip:

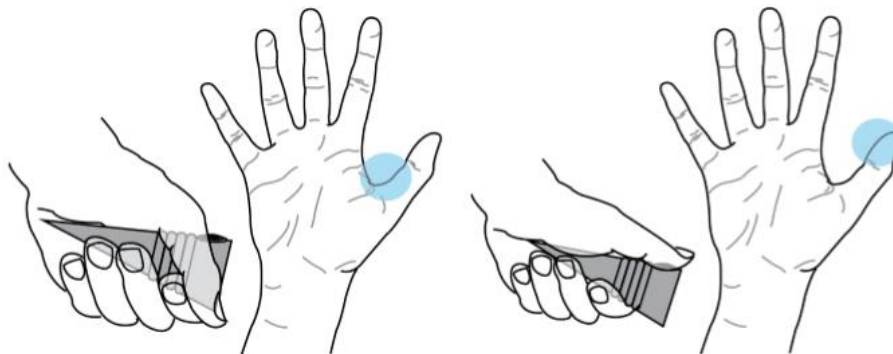

Figure 23: Pressure Points when Holding the 'Thumb Piece' (Source: Author)

3.3. Emotional Response & Pleasantness

As mentioned in Section 2.1, this research was based on two groups of users. In the three sections of analysis in this research, the 'Emotional Response and Pleasantness' is the only part where both user groups are taken into consideration.

The study of emotional levels of the users was based on the studies of Desmet (2010), Desmet P, Hekkert P (2007) and Jordan (1998). The study of the emotional response to a product is important since emotions are what bind or distance a user to/from the product's environment: "Emotions are functional, because they establish our position in our environment, pulling us toward certain people, objects, actions, and ideas, and pushing us away from others... This basic principle applies to all emotions; the intense emotion that we may experience in a situation that threatens basic survival needs and the subtle emotion that we may experience in response to human-product interaction. Pleasant emotions pull us to products that are (or promise to be) beneficial, whereas unpleasant emotions will push us from those that are (or promise to be) detrimental for our well-being... Appraisal is an evaluative process that serves to 'diagnose' whether a situation confronting an individual has adaptation relevance, and if it does, to identify the nature of that relevance and produce an appropriate emotional response to it" (Desmet P, Hekkert P. 2007. p61).

The above factors are equally applicable to medical instruments, since they interact directly with both groups of users and also are backed up with a psychological framework. The pleasantness or emotional stability of the user is highly important in medical equipment in both cases; to treat another using it or to be treated.

Emotional responses have no limit to their possibilities. But for the ease of analysis in this research, five emotional responses were selected for each user group, from the positive and negative manifestations of appraisal types introduced by Desmet (2010, p3):

User Group 01	User Group 02
1. Beneficial/ useless	1. Attractive/ unattractive
2. Effective/ineffective	2. Tolerable/ intolerable
3. Adequate/ inadequate	3. Trustworthy/ untrustworthy
4. Readable/ non-readable	4. Appealing/ appalling
5. Confident/ unconfident	5. Adaptable/ unadaptable

Figure 24: Selected Emotion Groups for Analysis of the Users

3.3.1 Emotional Response of the *Veda Mahattayas*

As the person who makes the first interaction with the product, the *Veda Mahattaya* plays a very important role in the functioning of the product. He is the one who must initially make an interaction with the product and understand how to use it and where. Therefore, the interview series was conducted in order to gather a rating of their emotional responses to the *Gokarna Yantra* based on the five emotions: *Beneficial/useless*, *Effective /ineffective*, *Adequate/inadequate*, *Readable/non-readable* and *Confident/non-confident*. The responses to the above emotional groups are not purely based on the product, but also has an effect from the experience and confidence of the user.

The user group ranged from using the product for the first time to experts in the area, and in this study group, 35% of the interviewees were first time users. The *Gokarna Yantra* was discussed here as a single object, without taking the variations into consideration. The data gathered from the users' responses are summarized under the following chart:

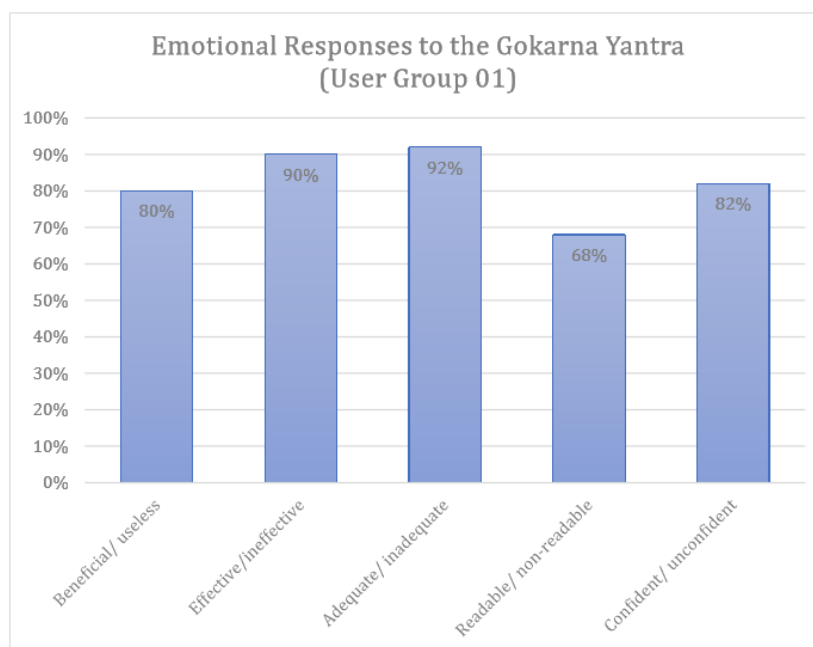

Figure 25: Emotional Responses to the Gokarna Yantra (User Group 01)

3.3.2 Emotional Response of the Patients

Having something dropped into your nose is an action that induces many reflex actions. Having oil dropped to your nose is even scarier. As the user group who must go through this stage during the treatment process, the emotional responses of the patients too are very important. The responses to the products are also influenced by the experience of the user, the trust he/she places on the doctor, and also his/her personal experiences.

The interviews conducted with the patients intended to gather their emotional responses to the *Gokarna Yantra* and analyzed in the form of ratings. The emotional responses were rated under five emotion groups: Attractive/unattractive, Tolerable/intolerable, Trustworthy/untrustworthy and Appealing/appalling, Adaptable/unadaptable. The analysis of the recordings is displayed in Figure 26 below:

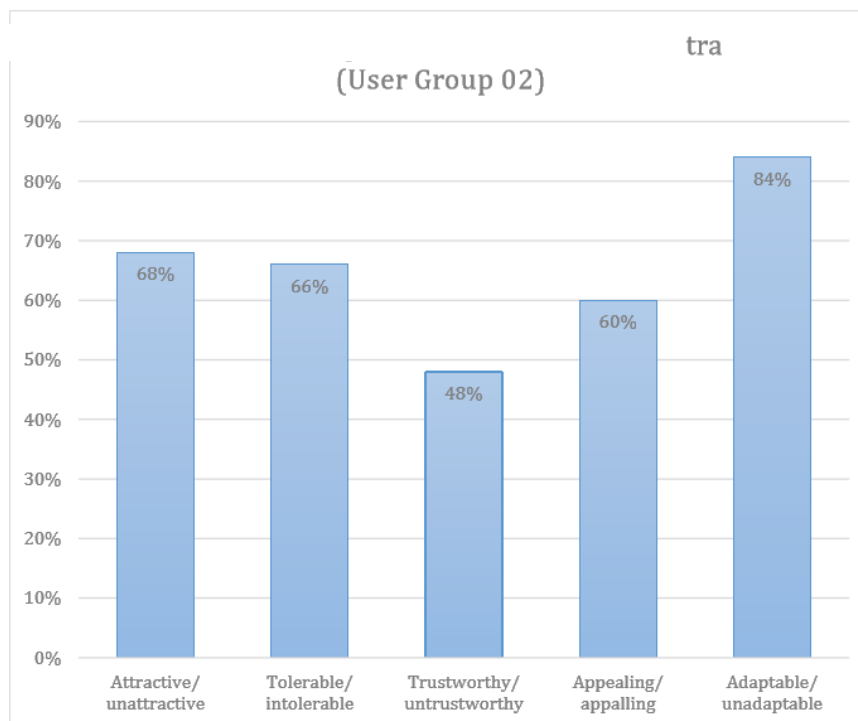

Figure 26: Emotional Responses to the Gokarna Yantra (User Group 02)

Conclusion

The Indigenous Medicine Practice of Sri Lanka has a powerful and rich history. As a knowledge system that is currently fading away with time, when looked into deeply, Sri Lanka's Traditional Medical system has great potential for future generations. This research addresses one such aspect of Sri Lankan Indigenous Medicine; the Usability of the utensils used, and the design considerations which have resulted in their continuation/discontinuation into the future.

Due to constraints in time and facilities, this research was limited to the instruments used for *Nasya Karma*, one of the most important treatment therapies in the modern-day context, due to the increased rate of patients suffering from stress, migraine, paralysis, etc. The *Nasya Karma* utensils were categorized by its function and the *Gokarna Yantra* was selected for analysis.

The *Gokarna Yantra* was analyzed under three main stages of the product experience; Form and Aesthetics, Attribution of Meaning and the Emotional Response and Pleasantness. Here, the Form and Aesthetics were studied to understand the basic physical aspects of the product, their parts and details. The Attribution of Meaning covered the semiotic aspects of the physical aspects discussed before; why they were placed in such a way and how they are intended to be used. The Emotional Response and

Pleasantness addressed the emotional and psychological responses of the users, and how the product's usability has helped in positioning it in the system.

The analysis of the products' physical aspects revealed that the products belonging to the most ancient times were highly crafted, with rich material usage, while the modern versions were more concerned with the ability to mass produce the objects. Therefore, the modern versions were simpler in design, cheaper and easy manufacturing material and techniques were used. The use of rich material and fine crafting in the products placed them in higher ratings of product experience, especially the practitioners, since they expressed a certain.

When Attributing Meanings to the products and their details, generally, the modern versions were simple in design, and therefore focused on only the main function. The older versions of the Nasya products had finely crafted detailing, which appeared to have deeper functional purposes in addition to their aesthetics.

The analysis of Emotional Responses and Usability of the *Nasya Upakarana* revealed that the doctors (practitioners) considered these products more usable than the patients. As a treatment method where the utensils used interact with both groups of users, the products revealed that the emotional responses of the patients were much more negative than those of the doctors.

As a social system where the knowledge was purely vernacular in origin, the average usability of *Nasya Upakarana* can be concluded as relatively high. This shows that our indigenous knowledge systems have great potential in providing knowledge that could be applied for better usable products in the future. The design aspects considered in building these products, even though originally intended for personal use, show that our ancestors were rich in knowledge and skill in creating highly usable product designs. While this research covers only the *Gokarna Yantra* used for *Nasya Karma*, this research itself is proof that there is fading knowledge in Sri Lanka that can be discovered and applied for products of the future.

As a designer, I believe it is essential that we unite to retrieve the traditional systems of knowledge that are gradually being forgotten due to Western influences, and uplift Sri Lanka's authentic values to build a better product design industry within the country.

References

- A S Vishen, Meenakshi, U K Sharma, B S Tomar. (2017). Significance of Nasya Karma in Panchakarma. *International Journal of Ayurveda and Pharmaceutical Chemistry*.
- Abeykoon, J. (n.d.). An Insight to Ayurvedic Medicine.
- Ayurvedic, H. (2014). *Panchakarma for Cleansing, Balancing, Healing & Rejuvenation*. Retrieved from Horawila Traditional Ayurveda, Sri Lanka: www.horawilaayurvedic.com/Panchakarma-treatment-Sri-Lanka.html
- David J. Rothman, Steven Marcus, Stephanie A. Kiceluk. (1995). *Medicine and Western Civilization*. Rutgers University Press.
- Definition of Medicine and Clinical Practice*. (2005). Retrieved from The Medical Council of New Zealand: <https://www.mcnz.org.nz/assets/Policies/Definitionmedicineandclinicalpractice.pdf>
- Deraniyagala, P. E. (n.d.). *History of the Oriental Medical Science Fund*.
- DeSilva, N. (2013). Sri Lanka's Traditional Knowledge & Traditional Cultural Expressions of Health & Wellbeing: History, Present Status & the Need for Safeguarding. *SAARC Regional Seminar on Traditional Knowledge & Traditional Cultural Expressions in South Asia*.
- DeSilva, P. L. (2006). The Sri Lankan Ayurvedic Tradition. *Asian Tribune*.
- Desmet, P. M. (2010). Three Levels of Product Emotion. *International Conference on Kansei Engineering & Emotional Reserach*.
- Digvijay Singh; D C Katoch; Shazina Saeed; Rajiv Janardhanan; Mehak Segan. (2018). Perception and Practice of Ayurveda Among Users and Non-Users: A Comparative Study. *International Journal in Res. Ayur. Pharm.*
- E Heinz; Muller-Dietz. (1975). *Historia Hospitalium*.
- Group, L. M. (2004). *Principles of Hand Tool Selection*. Loss Prevention Reference Note. LP 190 R4.
- Hekkert, P. (2006). Design Aesthetics: Principles of Pleasure in Design. *Psychology Science*, 157-172.
- Importance of Research in Ayurvedic Medicine. (n.d.). *The Island*.
- Jordan, P. W. (1998). Human factors for pleasure in product use . *Applied Ergonomics* , 25-33.
- K. M. Rathnayake; Tharrmini Roopasingam; V P Wickramasinghe. (2014). Nutritional and Behavirol Determinants of Adolescent Obesity: A Case-Control Study in Sri Lanka. *BMC Public Health*.

- Kusumarathne, K. L. (2005). *Indigenous Medicine in Sri Lanka: A Sociological Analysis*. Sarasavi Publishers.
- Naidu, R. K. (2018). *Nasya: Ayurvedic Herbal Nasal Oil*. Retrieved from The Ayurveda Experience: www.theayurvedaexperience.com/blog/nasya-benefits/
- Nair, P. K. (2010). Nasya: A Passage to the Brain. *Ayurveda & Health Tourism*, 10-15.
- Panchakarma for Cleansing, Balancing, Healing & Rejuvenation*. (2014). Retrieved from Horawila Traditional Ayurveda, Sri Lanka: www.horawilaayurvedic.com/Panchakarma-treatment-Sri-Lanka.html
- Park, Y. (n.d.). *Design Elements & Principles* .
- Patkin, M. (2001). *A Checklist for Handle Design*. Retrieved from Ergonomics Australia Online: <http://ergonomics.uq.edu.au/eaol/handle.pdf>
- Pieter Desmet, Paul Hekkert. (2007). Framework of Product Experience. *International Journal of Design*, 57-66.
- Renuka Jayatissa; S M Moazzem Hossain; Sandya Gunawardana; J M Ranbanda; Malsha Gunathilaka; P C De Silva. (2012). Prevalence and associations of overweight among adult women in Sri Lanka: a national survey. *Sri Lanka Journal of Diabetes, Endocrinology and Metabolism*, 2, 61-68.
- Salvo, D. (n.d.). *The Constitution of the Product: Form, Function, Material & Expression*. Retrieved from www.cs.emu.edu/~illah/CLASSDOCS/DiSalvoChapter2.pdf
- Samara, D. (2008). Keeper of Tradition. *Serendib Magazine*.
- Samarakoon, S. M. (2018, 08 01). Indigenous Medicine of Sri Lanka- Deshiya Chikitsa. (U. Mohotti, Interviewer)
- Times, T. S. (2016). 70% of Sri Lankans are Shifting to Indigenous Medicine.
- Tiwari, M. (1998). *Ayurveda: The Secrets of Healing*. Motilal Banarsidass Publishers (Pvt) Ltd.
- Uragoda, C. G. (1972). *Ceylon Today*.
- Uragoda, C. G. (1986). *Medicine & Surgery. Vidurava*, 19(1).
- Uragoda, C. G. (1987). *A History of Medicine in Sri Lanka*.

Samarawickrama, Sumanthri, et al (eds), 2018, "Sustainability for people - envisaging multi disciplinary solution": *Proceedings of the 11th International Conference of Faculty of Architecture Research Unit (FARU), University of Moratuwa, Sri Lanka, December 08, 2018* Galle pp. 482–491 ©

IMPACT OF WATER BODIES AS NATURAL LANDSCAPE ELEMENTS ON URBAN MICROCLIMATE IN THE CONTEXT OF DHAKA IN TERMS OF THERMAL COMFORT

MD RAISUL MOSTAFA¹ & SARJANA AFROZ²

^{1,2}Department of Architecture, Bangladesh University of Engineering and Technology,
Dhaka, Bangladesh

¹raisul1115@gmail.com, ²124archo702@gmail.com

Abstract

In urban areas, water bodies have a positive effect upon microclimate of the surroundings with the relative cooling impact through evaporative procedure. Water bodies have been proven to be influential methods of decreasing surrounding temperature as well as decreasing urban heat island effect. This study explores the potential impact of urban water body induced city cooling in the Dhaka context, with specific reference to the Hatirjheel Lake, Dhaka. In order to determine the impact of water bodies on urban context a simulation program ENVI-met was used to assess the air temperature, relative humidity and mean radiant temperature. The simulation intended to analysis the microclimatic conditions of Hatirjheel with and without water body and with green. Thus the simulation shows the effective impact of water body on the microclimate of an urban densely populated area by reducing temperature for outdoor thermal comfort. The results of this study can be helpful in defining urban design guidelines for reviving water bodies surrounded by mixed development in densely populated cities similar to Dhaka.

Keywords: *Urban Water Bodies, Urban Heat Island, Outdoor Thermal Comfort, ENVI-met, Dhaka.*

1. Introduction

In the past century we depend on natural sources for ensuring our comfort. But as we are developing our living standard, we are increasing our dependency on mechanical system for improving our comfort level and ignore the beneficial sources of nature as wind, water or sun. In hot humid climate the summer temperature is (>20°C) and winter temperature is (>0°C). Annual precipitation and humidity is high with frequent rain shower, relatively diurnal temperature fluctuation are typical (Harries and dines, 1998). The intergovernmental panel on climate change (IPCC) predicts a rise of mean annual temperature of about 3.3°C per century in the world. So that, the urban planning and design should seek to increase the characteristics of shading design, cooling from evaporation and breezing.

The rapid urbanization causes "urban heat island" effects and now it becomes more serious problem for mega city like Dhaka. The mean temperature of Dhaka, the capital of Bangladesh is increasing at an alarming rate in Contrast to its adjacent townships. This over-populated 500 sq.km city suffers from lack of natural elements like green open spaces and water bodies and is thereby affected by the urban heat island (UHI) effect. To mitigate the situation, rapid urbanization and climate change have led to a growing trend to bring nature into the cities (Chiang and Tan, 2009). Improper planning of areas and filling the water bodies for development disrupts the urban environment and creates a scenario which also characterized by highly dense built area and less open spaces and water bodies. Those water bodies can be converted to urban outdoor activity or recreational spaces if thermal comfort is ensured. The human organism continuously makes a balance between individual energy losses of heat and maintains the body core temperature in the range of 36.1-37.8°C. Air temperature, mean radiant temperature, relative humidity and wind speed are the environmental parameters that primarily affect thermal comfort of a human being. Water bodies are one of the elements to assist in cooling down the air around them via evaporation (Oke, 1992) and convection (Spronken-Smith, 2000). And this matter has

provided the core question for the current study: what is the impact of water bodies in the microclimates around them?

2. Literature review-

2.1. IMPACT OF WATER BODIES:

Water bodies can be manipulated and designed according to the climatic needs of a particular region (standard, 2004). Water bodies are a natural ecological structure which are made up of a volume of water and forms a physiographical feature (Ahmad, Ossen & lam, 2008). Urban water bodies, situated among parks and residential areas, play a crucial role in the ecological system in urban cities (Costanza, 1997). The rate of evaporation on the surface of water bodies are affected by the geometrical characteristics, region, and the surrounding landscapes (Ong, Mahlia, & Masjuki. 2011). It is concluded that the water bodies' geometry, shape, and depth can influence the variations of the Urban Cool Island (UCI) intensity; however, it is negatively correlated to the UCI efficiency of water body area (Tiang & Ishak, 2012). Besides that, the cooling potential of the water bodies is not dependent on the shape and depth of the volume of water (Tiang & Ishak, 2012). The role of urban water bodies are more apparent during hot summer days since it can contribute to human comfort by lowering the temperature of the surroundings and increase the humidity (Costanza, 1997). The presence of a shadow surface would also further magnify the cooling effects of water bodies. This proved the results of (Ong, Mahlia, & Masjuki. 2011) which stated that there is a significant relationship between the location and exchange of thermal loads from water bodies and the surrounding landscape. Basically, the best method to provide cooling effects in high temperature locations is to have many 'wet surfaces' to maximize the evaporation rate (tiang & Ishak, 2012).

2.2. EFFECT OF THERMAL CAPACITIES OF WATER BODIES

The thermal capacity of water is pretty large in a sense that it needs about three times more heat to raise a one-unit volume of water over the same temperature interval as the most soil (Wong, 2011, 2012). Sun, (2012) discovered a substantial decreased temperature of daytime land surface near the lalesin Beijing (China). Hatway and Sharples (2012) reported decreased air temperatures near the rivers inside UK. Furthermore, they suggested that the cooling effect was at its peak in early spring and starts to lower in June. Eventually, the rate for the diurnal temperature of water is lower than the one from the rural area, which means the maximum temperature are getting suppressed, and nocturnal temperature drop is limited. The direct link between the air temperature and the surface translates the mentioned signal to the temperature of screen level (Heusinkveld, 2010; Steeneveld, 2014). Throughout the night, the cooling impact weakens until it vanishes (nearly around 4:00 GMT) and afterwards, the lake stops to have its cooling effect. This is normally due to the air temperature getting lower than the temperature from water. And from this time, the body of water starts to get the surroundings warmer with the highest level on intensity around 6:00 GMT (Theeuwes, 2013).

2.3. THE CLIMATIC CONDITION OF DHAKA CITY:

In cities with hot climates, the UHI is one of the most negative factors, not only on human comfort and heat stress, but also on human health (Oke, 1994; Koppe et al., 2004; Gill, 2004; Gosling et al., 2009). Moreover, it has negative effects on energy use (more demand for air-conditioning), water use, air pollution meteorology (increased re-circulation/fumigation effects), air pollution chemistry (secondary transformation) and possibly on precipitation (Oke, 1994; Jauregui, 1997). Therefore, it is advantageous for human health and economy to mitigate its effects.

Being one of the most vulnerable countries, Bangladesh faces the temperature rising issues as the mean annual temperature here has increased during the period of 1895-1980 by 0.31°C over the past two decades. Dhaka, the capital of Bangladesh which is one of the densely populated mega cities, has a population over 15 million. Dhaka city includes 12.12% of green open space, while at least 25% is ideal for any city. The hard and bare surface of wall and roof of building and roads gains heat and causes the urban heat island effect (Ahmed, 1996). There are eight heavily urbanized areas in Dhaka where most of the heat is trapped and causes serious damages to environment. This is alarming for city dwellers too. The concept of 'healthy city' has only been recently adopted in developing cities. Annual maximum temperature of Dhaka is 34.5°C in summer season and minimum is 12.7°C during winter season

(Source: Dept. of Meteorology, Bangladesh). The UHI is the cause of about 1/3 of the total warming the city and it has been showed that excessive use of asphalt and concrete traps the heat mostly.

2.4. PRESENT CONDITION OF HATIRJHEEL AREA:

Hatirjheel is located at the centre of Dhaka. It has latitude of 23.7495 and a longitude of 90.3967. The Lake is surrounded by Tejgaon, Gulshan, Badda, Bansree, and Niketon. Although it has been a transportation medium for minimizing traffic congestion but it has brought a tremendous change in urban recreational life and the urban microclimate of these areas. During dry season the lake can hold approximately 3.06 billion liters of water and during dry season about 4.81 billion liters of water. As congested buildings permeate the most of Dhaka, hatirjheel attracts the city dwellers with its vastness of water and lush green with fresh air. Before the hatirjheel restoration project the space were filled with a dirty canal and was used for dumping wastes. As a result, environmental degradation is seen. Then the development of hatirjheel area was carried out by broadening the lake, reclaimed the environment as well as social improvement. Hatirjheel now symbolizes a remarkable example of environmental restoration.

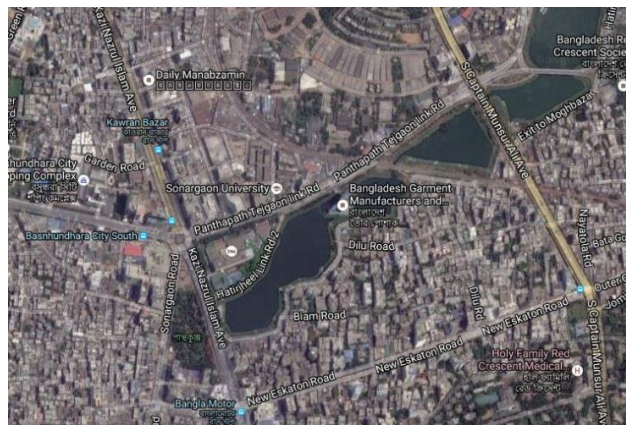

Fig 1: the present built form of hatirjheel area; source: Google map

3. Methodology:

The study method uses the computer simulation tool ENVI-met to explore:

- The effectiveness of an urban water body in influencing the microclimate.
- A water body in comparison to an urban green space of similar magnitude
- Microclimatic and thermal comfort changes within selected site of specific orientations, encompassing existing and simulated morphology.
- Impact of water body on the changes of humidity level and mean radiant temperature (T_{mrt}) in the specific site.

To frame the knowledge base, previous thermal condition researches, relevant to climatic condition of Dhaka have been studied. As Dhaka has developed without planning proposal, urban blocks were formed according to the owner's choice. The study has been carried out in an urban area Tejgaon with a lake hatirjheel. It is one of the highly UHI affected area. Street orientation: North-South and East-West direction. A 400mX400m area is selected for survey and analysis and the small area have all the characteristics to represent the whole area. Building height up to 36m is considered and various road width road widths are seen. The lake is surrounded by mixed use development and the orientation of the lake is north-east to south west and it is elongated to north-west to south-east. The study and analysis is done by experimental research method.

This study analyzes how water bodies have an impact on urban microclimate areas. Three dimensional microclimate models of the area were simulated in ENVI met in two stages. At first, the area models were simulated with the previous conditions of the lake, where the size of the lake was small the area was covered with herbs as grass and small plants. In the second stage, the same area models were

simulated the existing designed water bodies observe the extent and direction of changes in the microclimates of three urban canopy Layer (2 meters), using Student's 't' test.

Urban microclimate data from the simulation were collected from ENVI-met and were plotted in MS Excel. The temperature and relative humidity data from the simulation were analyzed with SPSS V12.

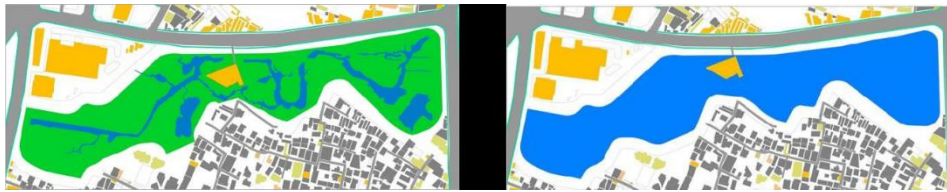

Fig 2: the previous (left) and the present (right) condition of the study area

3.1. SIMULATION WITH ENVI-MET V4.0

ENVI-met is three dimensional microclimate modeling software for simulating the surface, plant, air interactions in urban environment with a typical resolution of 0.5 to 54 m in space and 10 sec in time. ENVI-met uses a prognostic model based on the fundamental laws of fluid dynamics and thermodynamics (ii). ENVI-met outputs binary files which have to be imported into the visualization program LEONARDO, a graphical interface for displaying and analyzing numerical data. The output file displays the data with color coding.

Simulation period was from 9:00am to 5:00pm of June 23, 2016. Study area of around 100m×100m×36m was transformed in the ENVI-met model grid. This resulted in 34 grids with a resolution of 4m×4m×3m for the study area.

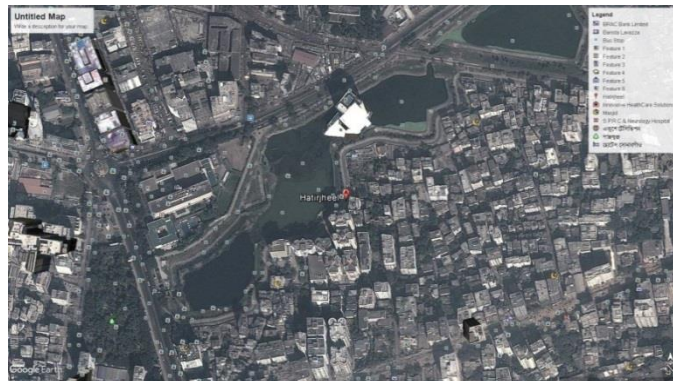

Fig 3: the present condition after restoring the lake, source: Google map 2016



Fig 4: the previous condition before restoring the lake, source: Google map 2006

3.2. ENVI-MET CONFIGURATION:

The ENVI-met configuration file (.cf) was created using the environmental readings listed in Table 1.

Table 1: data applied in the simulations.

Simulation parameters	Values	Simulation parameters	Values
Total Simulation Time	8 hours	Indoor Temperature [K]	303k
Start simulation at time	9.00 a.m.	Heat Transmission Walls [W/m ² K]	2.91
Wind Speed in 10 m ab. Ground [m/s]	2.6	Heat Transmission Roofs [W/m ² K]	6.00
Wind Direction (o: N.90: E.180: S.270: W.) 180	180	Latitude (o:North-:South) in degree	23.5
Initial Temperature Atmosphere [K]	297	Roughness Length z ₀ at Reference Point	0.1
Relative Humidity in 2m [%]	57%	Specific Humidity in 2500 m [g Water/kg air]	7

4. Simulation analysis and Results:

Table 2: present situation of study area of Hatirjheel

Time	Temp. (°C)		RH (%)		MRT (°C)		Wind Speed (m/s)	
	max	min	max	min	max	min	max	Min
9.00	33.78°C	28.69°C	83.49%	60.81%	64.57°C	36.12°C	3.64	0.00
10.00	36.98°C	29.87°C	79.91%	53.93%	64.01°C	41.10°C	3.62	0.00
11.00	38.76°C	30.86°C	75.23%	47.28%	61.62°C	45.46°C	3.62	0.01
12.00	39.96°C	31.59°C	68.79%	42.02%	56.72°C	51.84°C	3.64	0.01
13.00	41.08°C	32.59°C	61.76%	37.41%	67.13°C	51.55°C	3.66	0.01
14.00	42.12°C	33.64°C	55.08%	33.00%	74.15°C	53.08°C	3.65	0.00
15.00	42.19°C	34.16°C	51.24%	31.01%	76.88°C	51.16°C	3.67	0.00
16.00	41.00°C	33.89°C	50.35%	32.05%	75.76°C	46.12°C	3.66	0.00

Table 3: previous situation of study area of Hatirjheel

Time	Temp. (°C)		RH (%)		MRT (°C)		Wind Speed (m/s)	
	max	min	max	min	max	min	max	Min
9.00	34.65°C	30.69°C	85.29%	67.38%	65.33°C	37.87°C	3.69	0.00
10.00	38.77°C	32.71°C	82.72%	58.49%	65.76°C	43.29°C	3.66	0.01
11.00	41.35°C	33.98°C	77.62%	51.15%	63.94°C	47.59°C	3.67	0.01
12.00	42.74°C	34.77°C	69.19%	44.83%	59.72°C	53.75°C	3.68	0.01
13.00	43.81°C	35.86°C	60.38%	39.34%	70.04°C	54.30°C	3.69	0.01
14.00	44.65°C	37.22°C	52.59%	34.64%	76.92°C	56.90°C	3.70	0.01
15.00	45.17°C	38.16°C	47.40%	31.52%	80.24°C	55.66°C	3.71	0.01
16.00	44.41°C	38.12°C	45.91%	31.67%	78.51°C	51.67°C	3.71	0.01

4.1. COMPARATIVE ANALYSIS OF AIR TEMPERATURE:

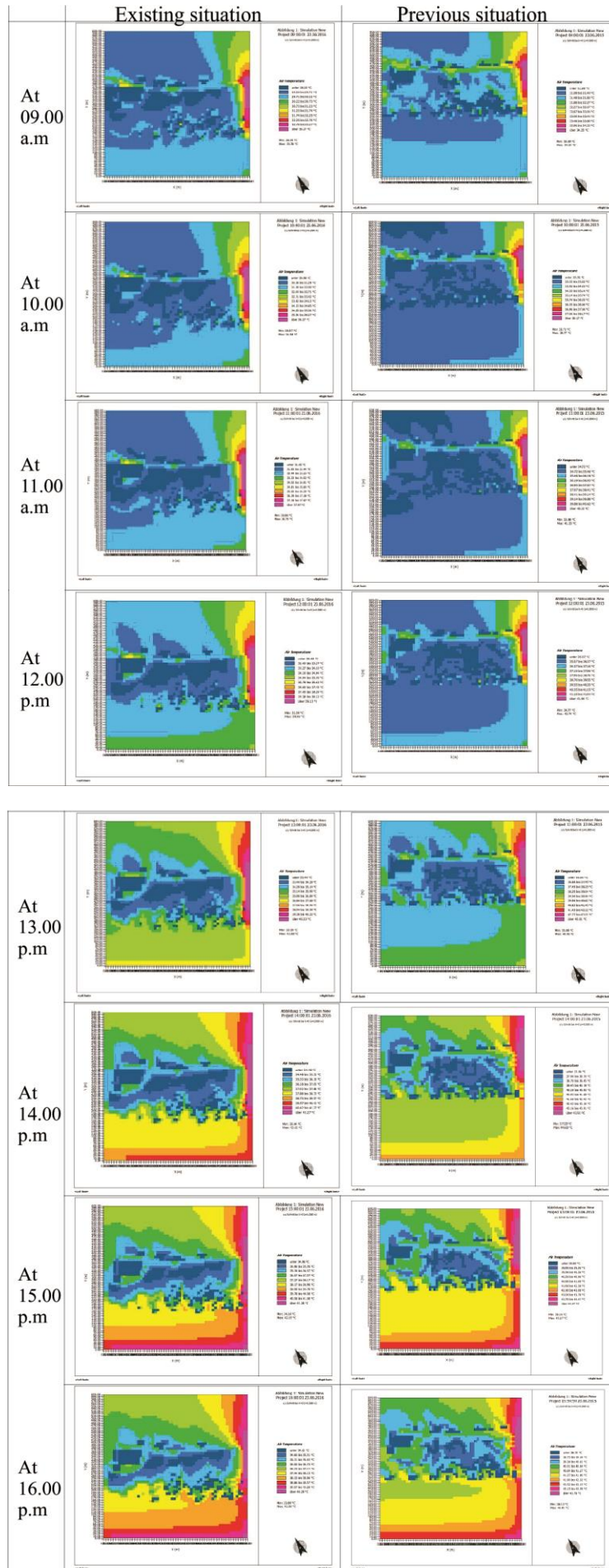

From the above figures, a comparative analysis is shown to understand the difference of air temperature in this urban area. According to the existing situation, at 9 a.m. the maximum temperature is 33.78°C and the temperature is gradually increasing with the time. At 9 a.m. south east side is the warmer side and north side is cooler than the others. From 10 a.m. to 13.00 p.m. the temperature difference is almost 6°C and almost remain constant at 14.00 p.m. the temperature reaches its highest as 42.12°C without the lake portion the overall average temperature remains around 37°C -39°C.as the water gain temperature gradually it absorbs heat all the time and releases heat at night. The lake portion is cooler than the other side of this area. At 15.00 pm the temperature is also highest as 42.19°C and gradually the temperature decreases from 42°C to 40°C at 16.00 pm in the afternoon. From the table it is seen that from 9.00 am to 16.00pm.the temperature of the lake portion is comparatively cooler than the other form and the ranges of the temperature is 29°C - 33°C, which is below from the core body temperature 37°C.

On the contrary, in previous situation with the lake, at 9.a.m. the maximum temperature is 34.65°C and south west side is cooler than the north east side. At 11 am the temperature is 41.35°C and at 12 pm the temperature is increasing 1.5°C as 42.74°C. Because of the presence of herbs, there are no shades as a result the temperature is increasing which is creating excessive heat on out comfort level. As in the previous situation the size of water body is small and the presence of herbs make the area warmer than the present existing situation. The temperature difference is 4°C -6°C and the open space with small lake area is cooler than others but not more than the existing situation. The temperature dissipates it heat and gradually warmer the adjacent area.as a result the overall temperature is higher than the existing situation. Green areas decreased this permeation rate at 15.00 pm the west side area began to affect by green herbs heat permeation because of direct solar radiation and lacking of shading.

4.2. Comparative analysis of Relative Humidity:

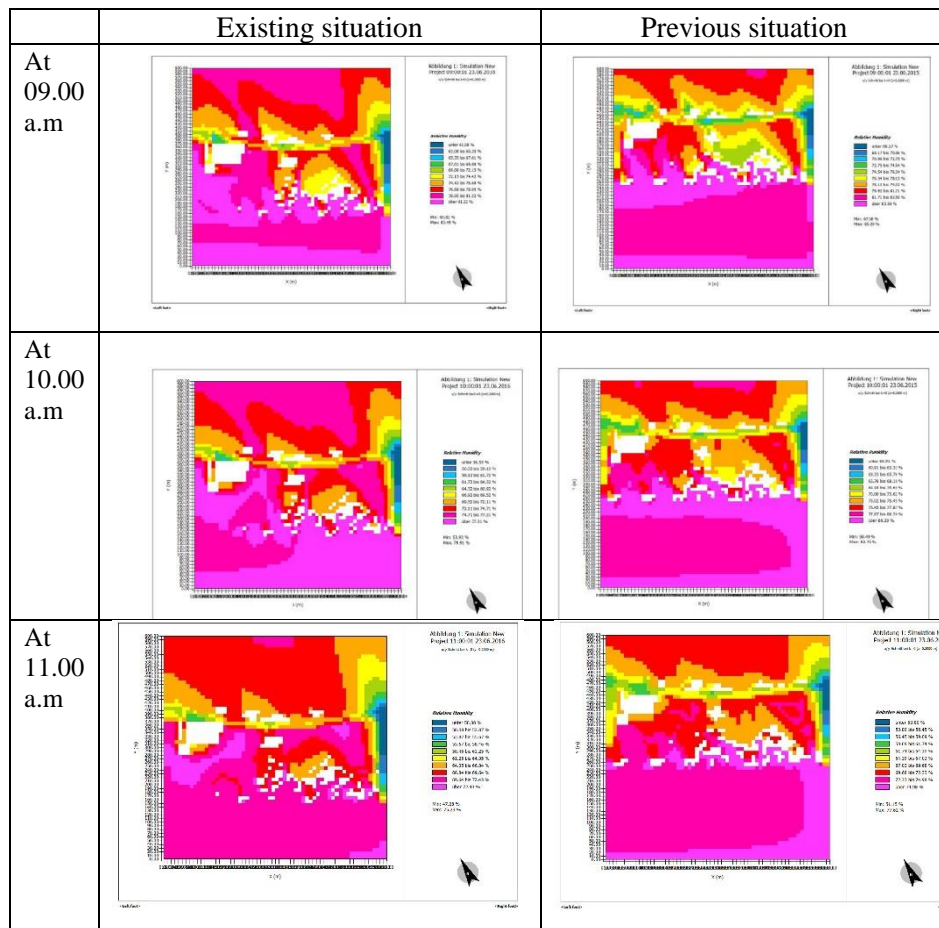

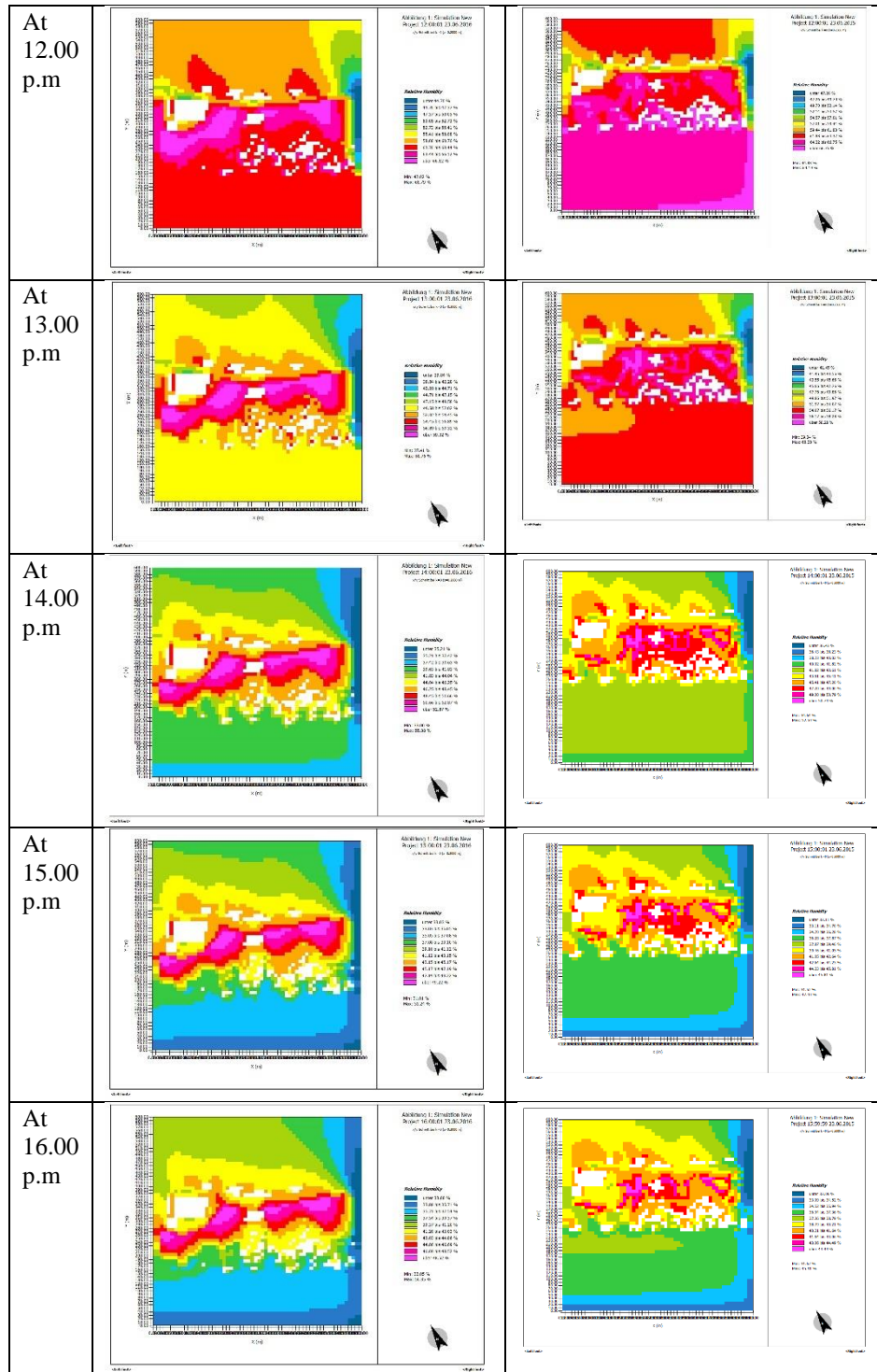

From the above figures, a comparative analysis is shown to understand the difference of relative humidity in this urban area. According to the existing situation, at 9 a.m. the maximum the maximum relative humidity is 83% which is less than 2% from the previous environment but higher than the average RH. The relative humidity is decreasing with the increasing of temperature and the difference between the existing and previous situation is very slight that is only 2-3% of average.as solar radiation increases, the water begins to evaporate at 10 a.m. This result shows that the temperature drop is induced by the evaporation of water from the water bodies and so that the relative humidity is increasing near the water body.as water absorbs heat and started to dissipate it from 16.00 pm to till night.in existing case the RH effects of the lake penetrate deep into the urban fabric resulting in comparatively higher values.

5. Discussion and Findings:

The simulation of previous and existing situation show that, the air temperature is decreasing in the existing situation because of the presence of large water body but relative humidity rate is high than the previous area near the water body. And the size of water body influences the urban microclimate area. Because of the vast open space with grass and small water body in the previous situation, there is no shading control and direct solar radiation so that the temperature is higher than the existing present situation. From the comparative analysis, it is observed from previous situation that types of vegetation influences the air temperature as tree reduces more air temperature than herbs. Air temperature near the water body relatively low and larger water body absorbs more heat than small one.

In the analysis, it is seen that the existing hatirjheel lake does not create a 'cool island' at the peak time of the day. The implications of an urban water body as a UHI mitigation strategy is not applicable for the peak time of day. Although, analysis shows that it can have a positive effect. The study also reveals that, in contrast to a small water body, a larger one will register higher. Further; it could be a concern as the air temperature near the water could eventually be the same or even higher than the surrounding air temperature in nearby urban areas. Solar radiation plays an important role in water bodies' cooling effect performance through evaporation. It affects the temperature reduction over a distance. Water bodies' evaporation during the day could increase the relative humidity amount in nearby areas. From the above comparative analysis of those two cases, it is perceived that the increase of relative humidity could produce a decrease of temperature near the water bodies and vice versa. So because of location of the hatirjheel water body, it is seen that the north west area are more cooler than the south east area in the existing situation as the temperature is relatively lower than the previous situation. But there are no changes in relative humidity. So, it is suggested that to reduce the existing relative humidity large and dense trees beside the water body may assist as shade less the temperature. A green option adversely affects the wind speed and RH at the edge of the lake. The effect of a green space is more local than that of a large water body. If the focus is on creating thermal comfort in specific areas, a green space is more required, while the water body option has more far reaching advantages for areas of the fabric extending beyond its confines.

6. Limitations:

This analysis specially focused on the impact of urban water bodies on the micro-climate of the surrounding area. Similar study can be done on other shapes of water bodies in term of orientation, size and build area pattern. In this research, no field data is taken. The tools to create the urban environment in ENVI-met are limited to buildings, soils/pavement materials and trees/vegetation and water bodies. It was not possible to add the thermal heat capacity of roads and pavements, building materials; but only a single constant indoor temperature.

7. Conclusion:

The temperature mitigation capacity of water may improve the microclimate; even though the higher levels of humidity that is caused by water should also be considered. In order to make healthy environments in future cities, a more improved understanding of the water capacity is required in an attempt to get opportunities for the action. Water that has a lower temperature in comparison to its surroundings will always work as a cooling factor and also vice versa. As the water has a role of a buffer for the diurnal temperature cycle; it cools the environment over the course of day and makes it cool at night. A consequence of this study can be that when bodies of water have reached a higher rate of temperature over the hot seasons, they are capable of acting as night warming elements, and hence can be adverse to the thermal comfort.

8. Acknowledgement

We would like to thank all of the people who helped make this investigation possible, in particular our course teacher Dr. Khandaker Shabbir Ahmed, Dr. Md. Ashikur Rahman Joarder and the Dept. of Architecture, BUET, Dhaka, Bangladesh for technical support.

9. References

- M. Ahmad, D. R. Ossen, and J. Kui Lam, Effect of Urban Geometry on Solar Insolation Threat in JSNAC (Pilot Study), 2008.
- R. Emmanuel, "A hypothetical 'shadow umbrella' for thermal comfort enhancement in the equatorial urban outdoors," R. Emmanuel, *An Urban Approach to Climate Sensitive Design: Strategies for the Tropics*, Taylor & Francis, 2005.
- T. L. Tiang and D. Ishak, "Technical review of wind energy potential as small-scale power generation sources in Penang Island Malaysia," *Renewable and Sustainable Energy Reviews*, vol. 16, no. 5, pp. 3034-3042, 2012.
- R. Costanza et al., "The value of the world's ecosystem services and natural capital," *Nature*, vol. 387, no. 6630, pp.253-260, 1997.
- H. Ong, T. Mahlia, and H. Masjuki, "A review on energy scenario and sustainable energy in Malaysia," *Renewable and Sustainable Energy Reviews*, vol. 15, no. 1, pp. 639-647, 2011.
- Gill, S. (2004): Literature Review; Impacts of Climate Change on Urban environments. Centre for Urban and Regional Ecology, University of Manchester, 72p.
- Gosling, S.N., Lowe, J.A., McGregor, G.R., Pelling, M. y Malamud, B.D. (2009): Associations between elevated atmospheric temperature and human mortality: a critical review of the literature, *Climatic Change*, 92, 299-341.
- Oke, T.R. (1994): Keynote Address to the Technical Conference on Tropical Urban Climates (TeCTUC), WMO/TD No. 647, p. 23-27.